

---

---

**0.4M CMOS camera**

**ID0M4B-CL (B/W)**

**ID0M4C-CL (Color)**

**Technical Manual**

**iDule CORPORATION**

---

---

## Table of contents

PAGE

1.	Product Details .....	3
2.	configuration .....	3
2.1.	Standard Configuration .....	3
2.2.	Free Software .....	3
2.3.	Packing Specifications .....	3
3.	Handling precautions .....	3
4.	Main Standards .....	4
4.1.	General Major Standards .....	4
4.2.	Camera Input/Output Signal Standards .....	5
4.3.	Spectral Sensitivity Characteristics *Excludes lens characteristics and light source characteristics. ....	6
5.	External Connection Connector Specifications .....	7
5.1.	Camera Link Connector 12226-1100-00PL(3M) .....	7
5.2.	Power LED .....	7
5.3.	12-pin circular connector HR10A-10R-12PB(74) (Hirose) equivalent (CN1) .....	8
6.	Timing Chart .....	9
6.1.	2Tap Base Configuration Horizontal synchronization .....	9
6.2.	2Tap Base Configuration Vertical synchronization .....	9
6.3.	2Tap Base Configuration (HS mode) Horizontal synchronization .....	10
6.4.	2Tap Base Configuration (HS mode) Vertical synchronization .....	10
6.5.	3Tap Base Configuration (HS mode) Horizontal synchronization .....	11
6.6.	3Tap Base Configuration (HS mode) Vertical synchronization .....	11
6.7.	Image Output Format .....	12
6.8.	Fixed Trigger Shutter Mode .....	13
6.9.	Pulse Width Trigger Shutter Mode .....	14
7.	Partial Scan Mode .....	15
8.	8bit HS mode (High Speed Mode) .....	17
9.	Serial communication function .....	18
9.1.	Command description .....	19
9.2.	Control example .....	24
10.	Function setting (Sets the function of the camera using serial communication. ) .....	28
11.	Dimensions .....	30
12.	Factory Settings .....	31
13.	Warranty Coverage .....	32
14.	About CMOS pixel defects .....	32
15.	Product Services .....	32

---

---

## 1. Product Details

This camera is a Camera Link camera that uses a 6.3 mm diagonal 0.4M CMOS image sensor manufactured by Sony. The time required to read out all pixels is 1/523 when 3Tap Base Configuration is output.

### Feature

- Global shutter CMOS sensor
- Fixed Trigger Shutter Mode, Pulse Width Trigger Shutter Mode
- Input power (12pin connector or PoCL)
- 8-bit HS mode (High Speed Mode) supports high frame rate output

\*The amount of saturated signal of the image sensor is 1/4

- Full frame rate and resolution of video output

2Tap Base Configuration	319.96 fps	8bit / 10bit / 12bit
	391.06 fps	8bit (HS mode)
3Tap Base Configuration	523.58 fps	8bit (HS mode)

## 2. configuration

### 2.1. Standard Configuration

- Camera body

### 2.2. Free Software

- iDule Control Panel (Software)

### 2.3. Packing Specifications

- Individual carton
- Master carton (20 units)

## 3. Handling precautions

**Important: Please observe the following precautions in order to use the camera correctly.**

**Any failure or malfunction of the camera caused by incorrect use without following these precautions is not covered by the product warranty.**

**This unit cannot be used for devices whose failure or malfunction may directly threaten human life or cause harm to human beings (equipment for special applications such as nuclear power and aerospace).**

- To protect the camera, do not use in dusty or humid places.
- Handle the camera carefully so as not to subject it to strong shocks or static electricity. Failure to do so may result in a malfunction.
- To protect the CMOS image sensor, do not directly capture images from direct sunlight or high-intensity light. Also, when not in use, please put a protective seal on it.
- To connect to the camera, see "5. Please follow the instructions for "External Connection Connector Specifications". Please note that the wrong connection may not only damage the camera itself, but also cause irreparable damage to the connected device.
- If there is an AC leak from the device (monitor, computer, etc.) connected to the camera, the camera may be damaged. After fully checking the ground potential between the two parties, make sure that there is no problem before connecting.
- Use the camera's power supply voltage correctly within the specifications. If you use a power supply that does not meet the specifications or an unstable power supply, the camera may malfunction or malfunction.
- When turning the camera back on, wait at least 2 seconds before turning it on.
- Camera input power supply DC+12V± 10% ripple should be supplied within ±50mV. It may appear as noise in the image signal.
- Please make sure that there is no noise such as chatter when the power supply starts.

#### 4. Main Standards

##### 4.1. General Major Standards

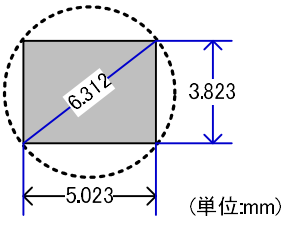
(1) Image sensor	Imaging Type	6.3mm diagonal global shutter (Sony IMX287)	
	Total number of pixels	728(H) x 554(V)	
	Pixel size	6.90μm(H) x 6.90μm(V)	
	Image Circle	Φ6.313mm	
			
(2) Video Output Frequency	CLK Frequency	85MHz	
	Output Effective Pixels	728(H) x 544(H)	
	2Tap Base Configuration	319.96fps 391.06fps HS Mode	453 (H) x 586 (V) : Including blanking 371 (H) x 586 (V) : Including blanking
	3Tap Base Configuration	523.58fps HS Mode	277 (H) x 586 (V) : Including blanking
(3) Video Output System	2Tap Base Configuration Interleave 3Tap Base Configuration Interleave		
(4) Output Format	Sensor AD	12bit, 8bit (HS mode)	
	Camera Link output	8bit / 10bit / 12bit 8-bit HS mode (High Speed Mode) *The amount of saturated signal of the image sensor is 1/4	
(5) Sensitivity	black and white	F4	2000lx
	color	F2.8	2000lx
(Conditions: Shutter speed 1/320s(OFF), Gain 0dB, 2Tap Base Configuration)			
(6) Minimum Illumination	black and white	F1.4	10lx
	color	F1.4	20lx
(Conditions: Shutter Speed 1/320s(OFF), Gain +12dB, 2Tap Base Configuration)			
(7) Power Input Voltage	DC+12V±10% (12pin connector or PoCL)		
(8) Power Consumption	type 1.5 W max 1.8 W		
(9) Dimensions	H:29.0mm W:29.0mm D:29.0mm excluding projection		
(10) mass	Approx. 50g		
(11) Lens Mounts	C-mount		
(12) Gain	0dB ~ +12dB		
(13) Shutter speed	2Tap Base Configuration	1/51000s ~ OFF(1/320s) 1/54000s ~ OFF(1/391s) : HS mode	
	3Tap Base Configuration	1/57000s ~ OFF(1/523s) : HS mode	
(14) Slow shutter	2Tap Base Configuration	OFF(1/320s) ~ 800.1ms OFF(1/391s) ~ 654.6ms : HS mode	
	3Tap Base Configuration	OFF(1/523s) ~ 488.9ms : HS mode	
(15) Trigger Mode	Fixed shutter trigger mode , Pulse width shutter trigger mode		
(16) Partial Scanning	Full Frame Rate ~ 4 lines (4 lines/step)		1 partial area
(17) Safety Quality Standards	CE Standards	Emission : EN61000-6-4:2007+A1:2011 Immunity: EN61000-6-2:2005	
	RoHS Directive Compliant		
(18) Durability	Vibration	20~200 Hz, acceleration 98m/s <sup>2</sup> (10G), X, Y, Z in each direction (120 minutes in resistance)	
	Shock Resistance	Unpacked± up to 980m/s <sup>2</sup> (100G) applied in X, ±Y, ±Z6 directions It must be able to withstand impacts.	
(19) Environment conditions	Operating Temperature	-5°C ~ +50° C Humidity 0 ~ 90%RH However, it should not condense.	
	Storage temperature	-25° C ~ +65°C Humidity 0 ~ 90%RH However, it should not condense.	

## 4.2. Camera Input/Output Signal Standards

(1) Video output data	Effective video output	728(H) × 544(V)	(in full-frame scan mode)
(2) Synchronous signal output	LVAL FVAL DVAL SP (Exposure signal)	Camera Link output(LVDS)	
(3) Camera Control Signal Input	CC2·CC3·CC4	Camera Link input(LVDS)	(Unused)
(4) Trigger signal input	CC1	Camera Link input(LVDS)	(Switchable to CN1 input at address 06)
	polarity	Positive Polarity/Negative Polarity	(Polarity switchable at address 05)
	Pulse width	1HD (minimum) ~ about 2 frames	
(5) Serial communication	SerTC (Serial to Camera)	Camera Link input(LVDS)	
	SerTFG (Serial to FrameGrabber)	Camera Link output(LVDS)	
(6) Video signal	White Clip Level	FFEh	(Gain 0dB, 12bit output)
	Setup Levels	060h or less	
	Dark shading	Horizontal vertical と も 00Fh or less	
(7) Trigger signal CN1 input	CN1 : 11 pins	Low1.4V(max),High3.3V~5.0V	(Can be switched to CC1 input at address 06)
(8) Exposure signal CN1 output	CN1 : 6 pins	Low0.55V (max), High3.8V (minimum)	
(9) FVAL signal CN1 output	CN1 : 7 pins	Low0.55V (max), High3.8V (minimum)	

Trigger signal CN1 input circuit

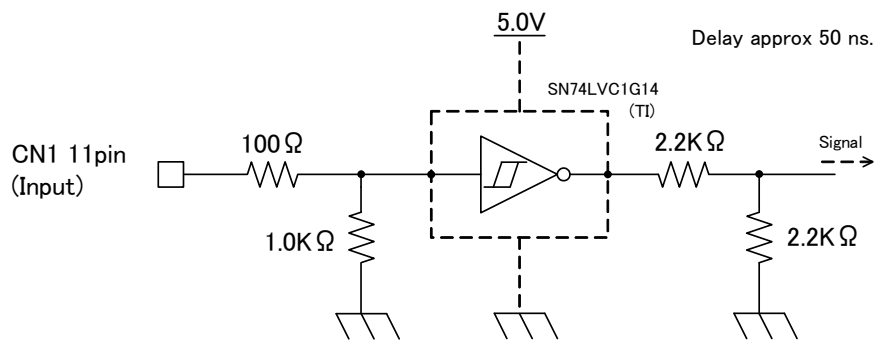

Exposure signal CN1 output, FVAL signal CN1 output circuit

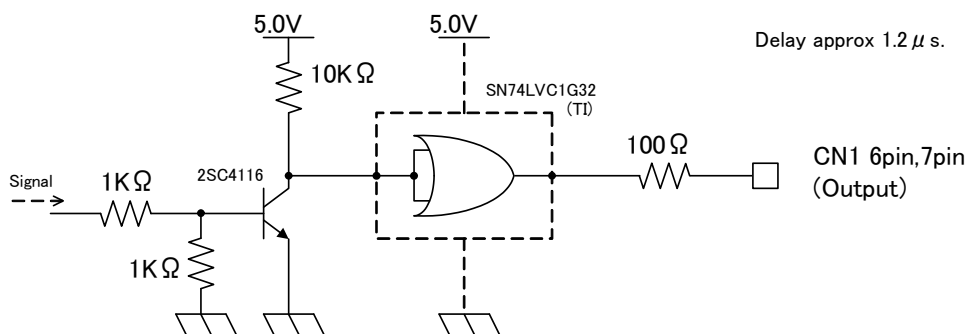

4.3. Spectral Sensitivity Characteristics \*Excludes lens characteristics and light source characteristics.

ID0M4B-CL

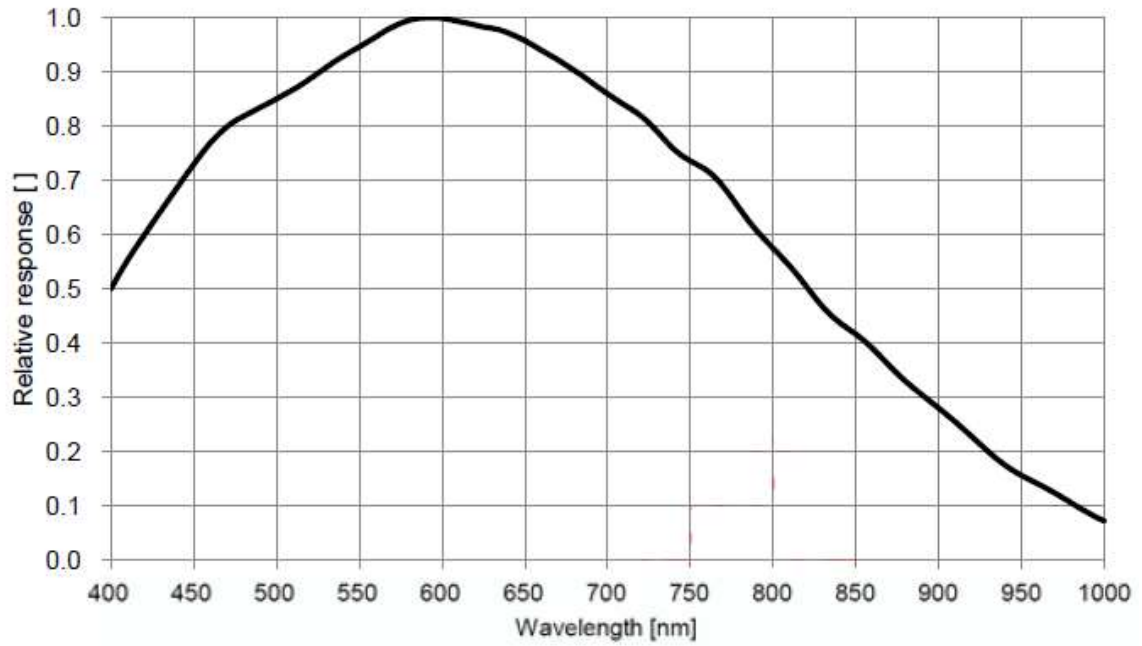

ID0M4C-CL

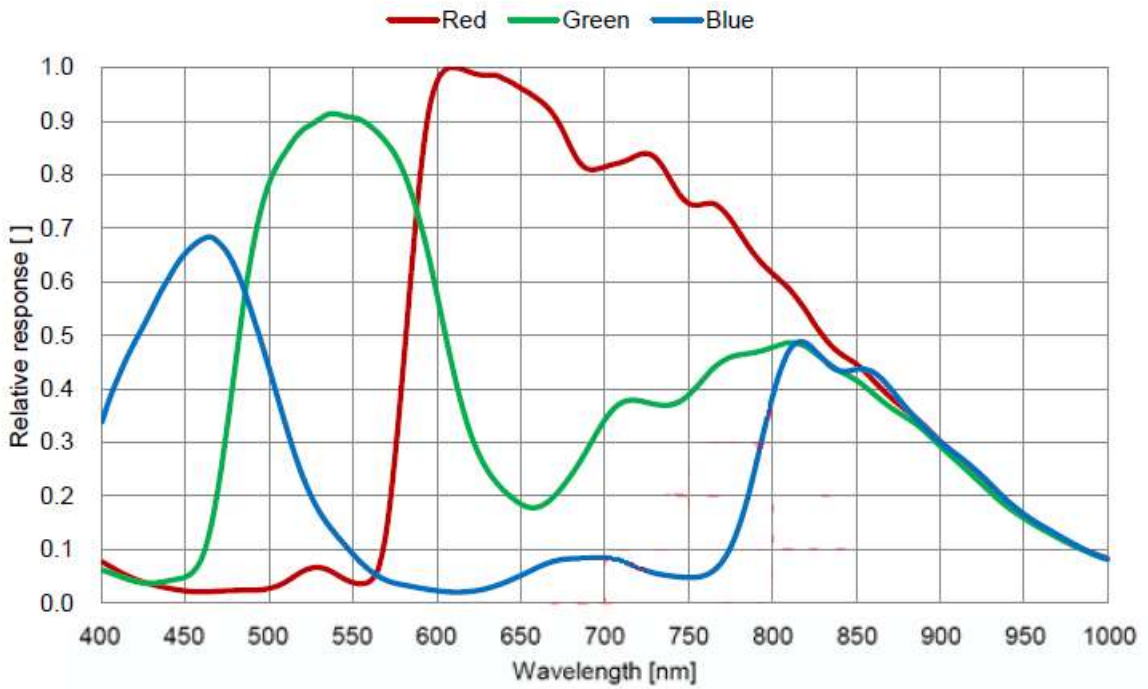

---

---

## 5. External Connection Connector Specifications

### 5.1. Camera Link Connector 12226-1100-00PL(3M)

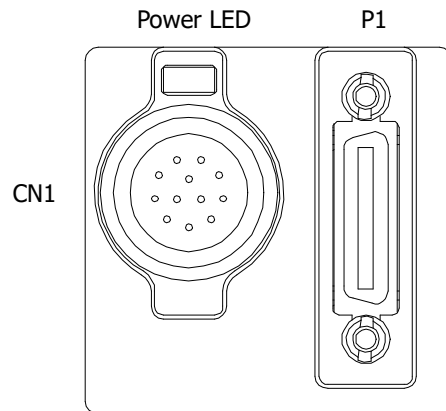

#### Connector (P1)

pin number	Name	pin number	Name
1	<b>+12V(PoCL)</b>	14	<b>GND</b>
2	X0-	15	X0+
3	X1-	16	X1+
4	X2-	17	X2+
5	Xclk-	18	Xclk+
6	X3-	19	X3+
7	SerTC+	20	SerTC-
8	SerTFG-	21	SerTFG+
9	CC1- (Trigger IN -)	22	CC1+ (IN+ Trigger)
10	CC2+	23	CC2-
11	CC3-	24	CC3+
12	CC4+	25	CC4-
13	<b>GND</b>	26	<b>+12V(PoCL)</b>

\* Do not supply power from both P1 and CN1.

### 5.2. Power LED

Lights up when the camera is operational. If there is no power supply or the camera is faulty, the LED will not light up.

\* With the serial setting, the LED can be turned off (address 1B).

---

---

5.3. 12-pin circular connector HR10A-10R-12PB(74) (Hirose) equivalent (CN1)

Pin Number	name
1	GND
2	Power supply (DC+12V)
3	GND
4	NC
5	GND
6	Vertical simultaneous output (FVAL signal)
7	Exposure signal
8	GND
9	NC
10	NC
11	Trigger Signal Input
12	GND

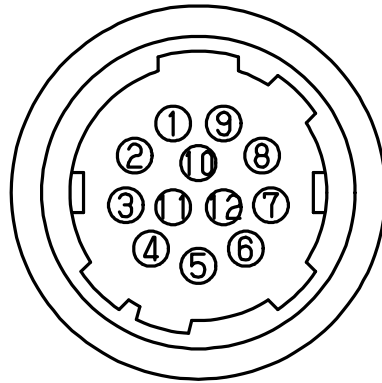

\* Do not supply power from both P1 and CN1.



## 6. Timing Chart

### 6.1. 2Tap Base Configuration Horizontal synchronization

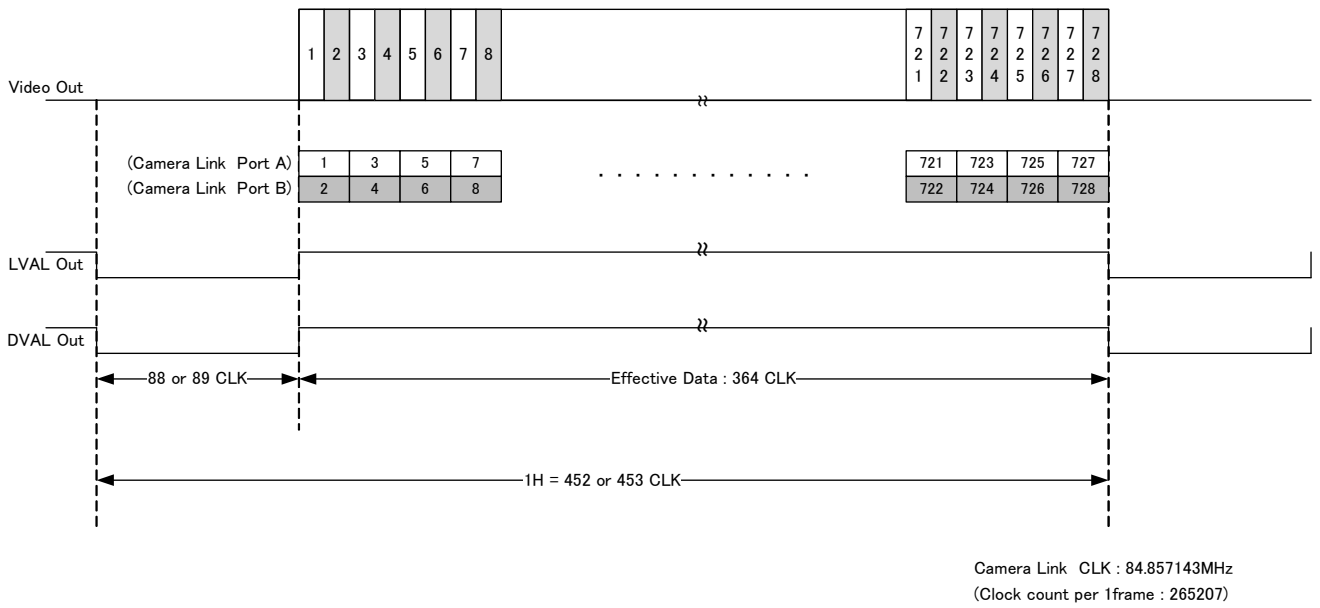

### 6.2. 2Tap Base Configuration Vertical synchronization

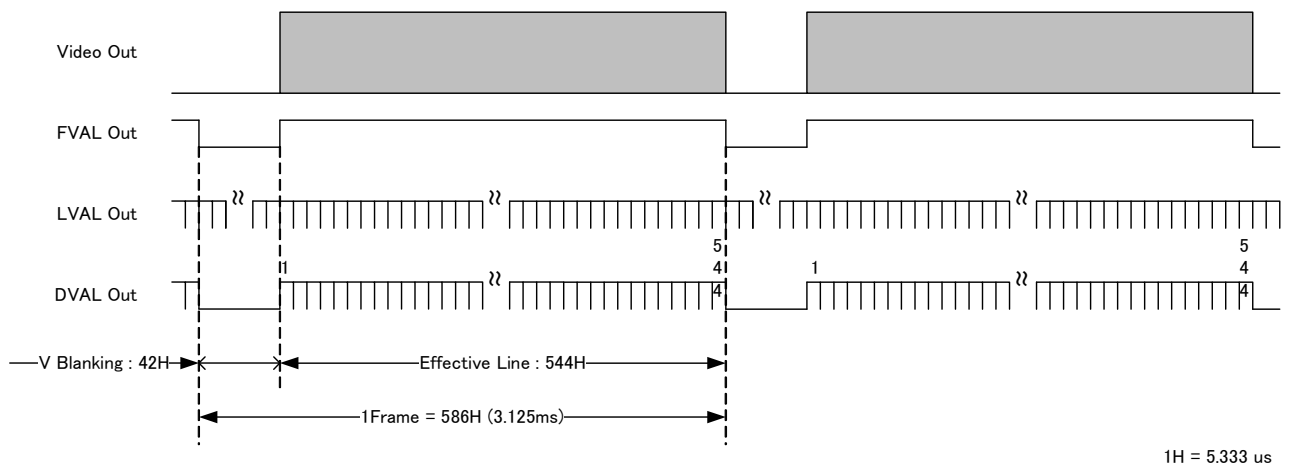

### 6.3. 2Tap Base Configuration (HS mode) Horizontal synchronization

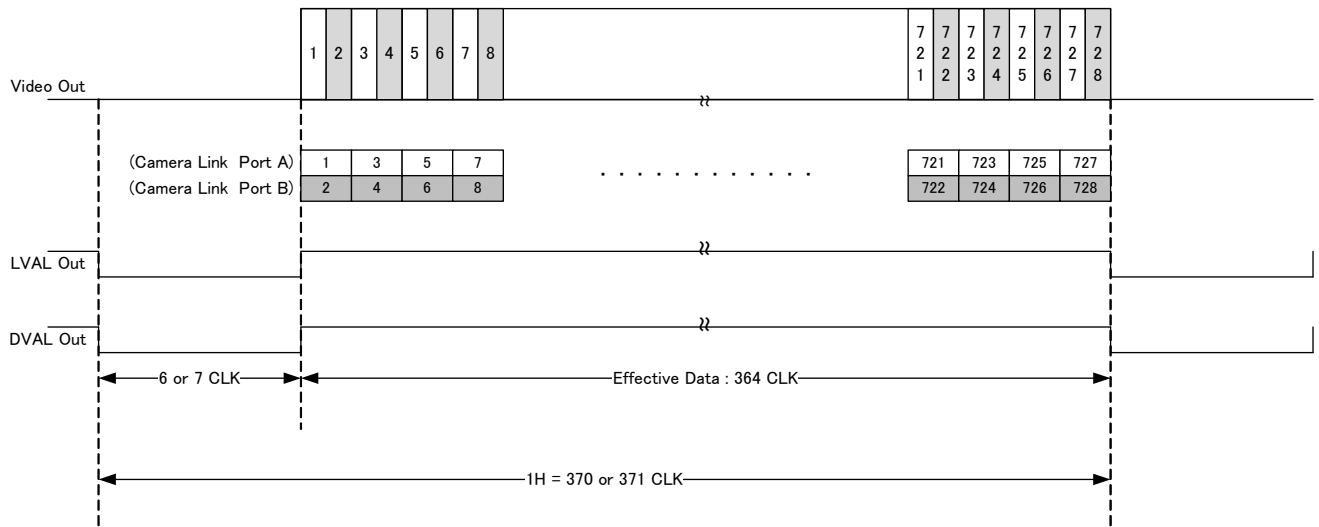

Camera Link CLK : 84.857143MHz  
 (Clock count per 1frame : 216987)

### 6.4. 2Tap Base Configuration (HS mode) Vertical synchronization

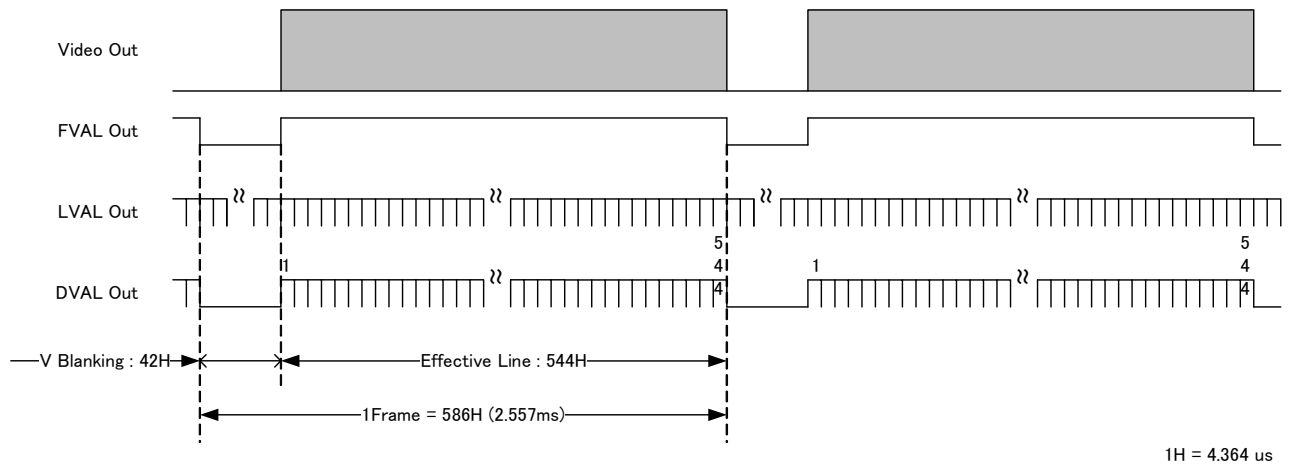

### 6.5. 3Tap Base Configuration (HS mode) Horizontal synchronization

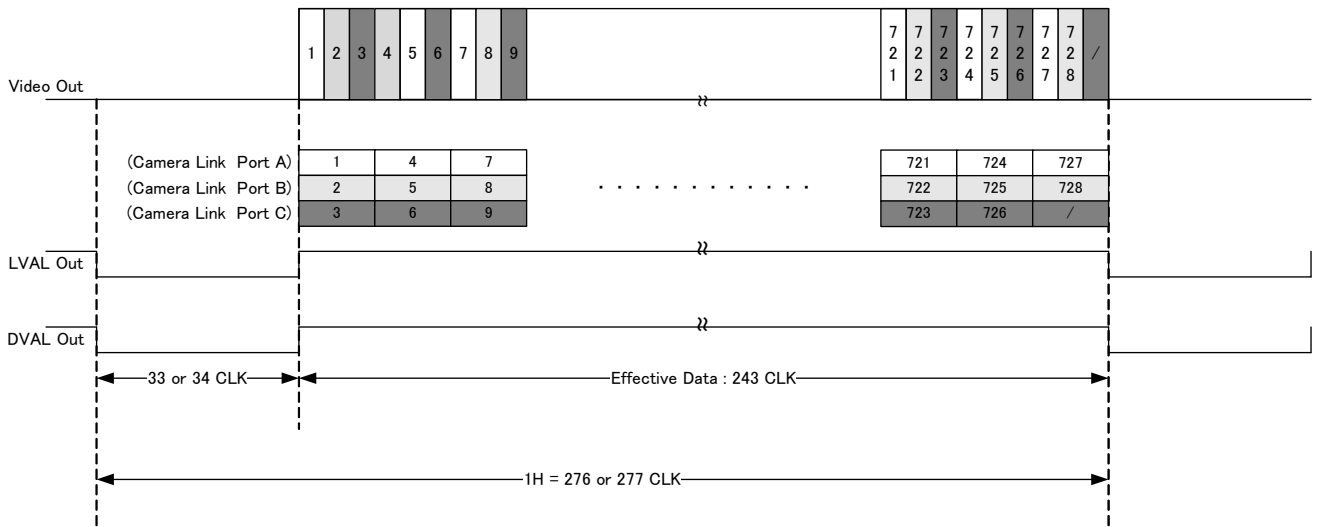

Camera Link CLK : 84.857143MHz  
(Clock count per 1frame : 162071)

### 6.6. 3Tap Base Configuration (HS mode) Vertical synchronization

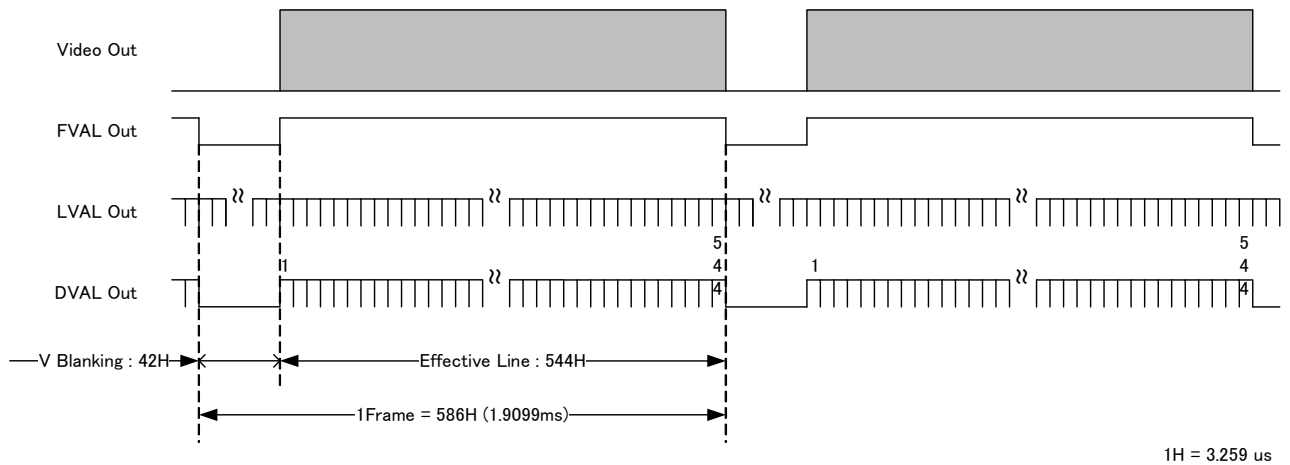

## 6.7. Image Output Format

### 2Tap Base Configuration

#### ID0M4B-CL

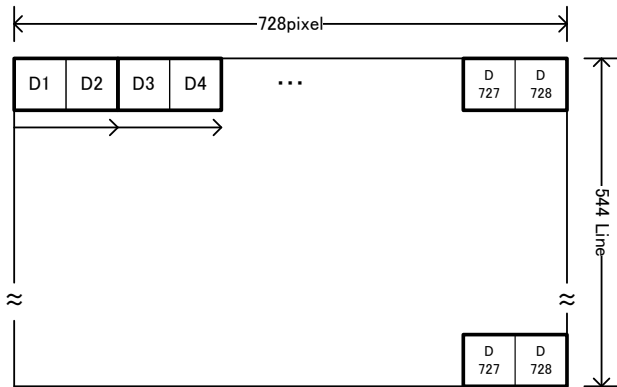

#### ID0M4C-CL

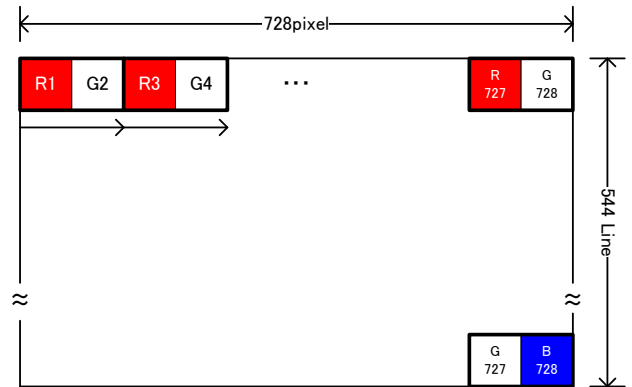

### 3Tap Base Configuration

#### ID0M4B-CL

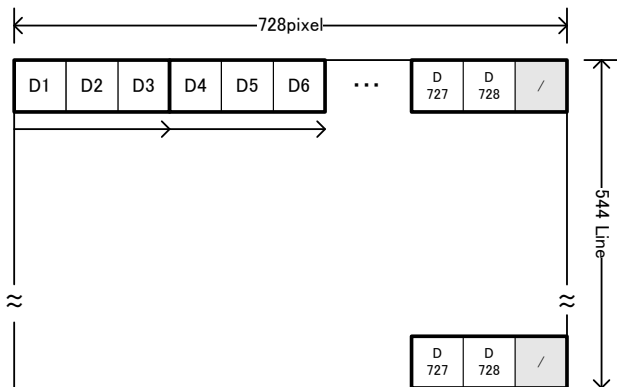

#### ID0M4C-CL

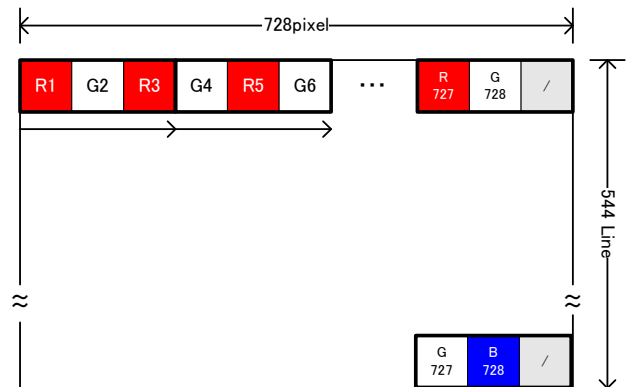

## 6.8. Fixed Trigger Shutter Mode

- This mode starts exposure with a trigger signal input from an external source, and sets the exposure time with a serial communication command.
- Exposure Time Delay from detecting the trigger edge inside the camera to starting exposure

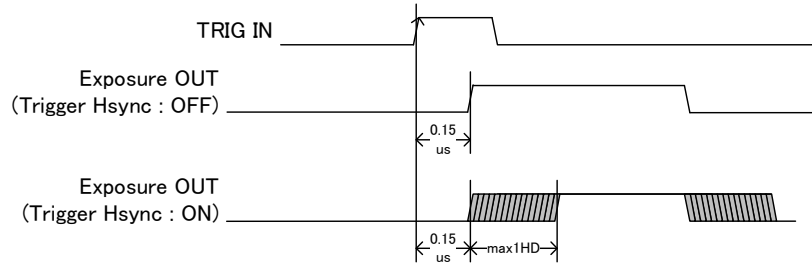

(1) Trigger Hsync Mode OFF : 0.15 us fixed

(2) Trigger Hsync Mode ON : 0.15 us + max1HD

• 2Tap Base Configuration

• 2Tap Base Configuration (HS mode)

• 3Tap Base Configuration (HS mode)

$$0.15\text{us} + \begin{cases} \text{max 1HD (5.333us)} \\ \text{max 1HD (4.364us)} \\ \text{max 1HD (3.259us)} \end{cases}$$

- Trigger input is also accepted during the image output period.

However, do not enter a trigger signal for the exposure setting that causes the next image output to start before the image output is completed.

- Trigger inputs during the Exposure Time are ignored in the camera. (Figure (A) below)

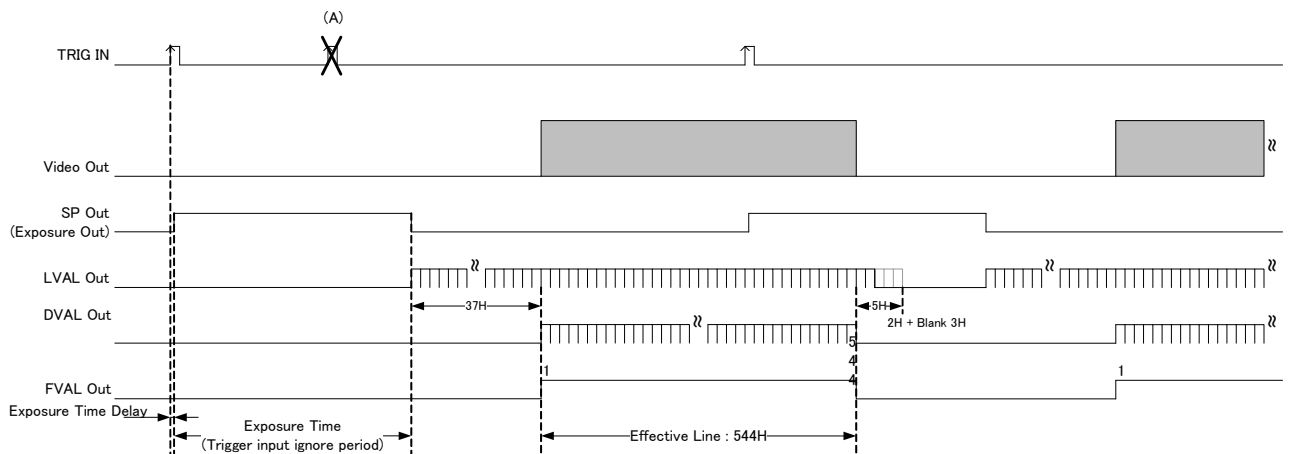

- Trigger Hsync Mode When set to OFF, the delay time before starting exposure is fixed.

However, when used in an operation that starts exposure during image output (overlap readout operation),

Depending on the input timing of the trigger, the exposure start line may appear as line noise.

## 6.9. Pulse Width Trigger Shutter Mode

- This mode starts the exposure with a trigger signal input from the outside, and sets the exposure time according to the width of the trigger signal.
- Exposure Time Delay from the time the trigger edge is detected inside the camera until the exposure starts or ends

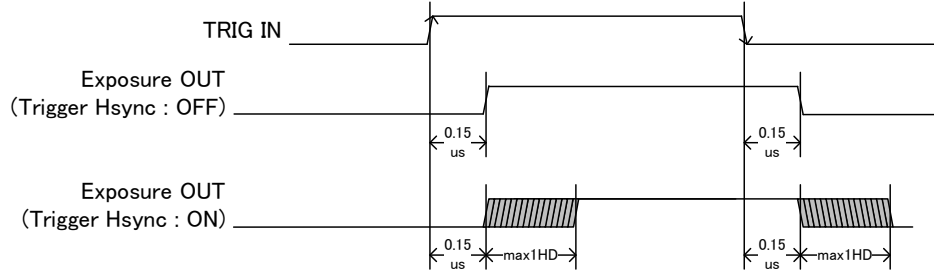

(1) Trigger Hsync Mode OFF : 0.15 US fixed

(2) Trigger Hsync Mode ON : 0.15 us + max1HD

• 2Tap Base Configuration

• 2Tap Base Configuration (HS mode)

• 3Tap Base Configuration (HS mode)

$$0.15\text{us} + \begin{cases} \text{max 1HD (5.333us)} \\ \text{max 1HD (4.364us)} \\ \text{max 1HD (3.259us)} \end{cases}$$

- Pulse width 1HD (minimum) ~ about 2 frames.

In terms of function, there is no upper limit, but during long exposures, noise such as dark noise and shading may be noticeable.

If the pulse width is shorter than 1HD, the exposure time is controlled with an upper limit of 1HD.

- Trigger input is also accepted during the image output period.

However, do not enter a trigger signal for the exposure setting that causes the next image output to start before the image output is completed.

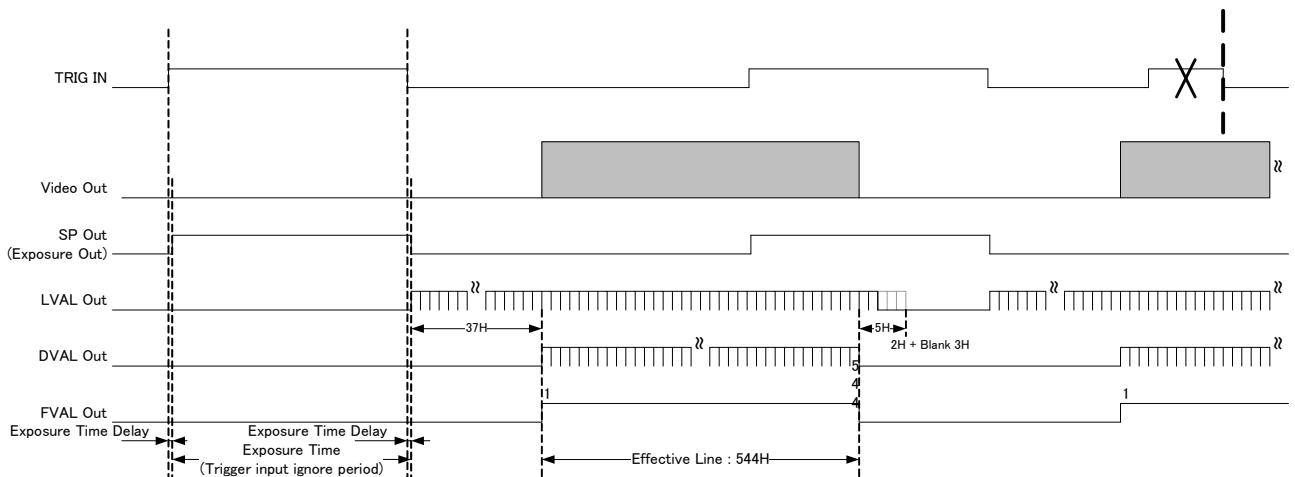

- Trigger Hsync Mode When set to OFF, the delay time before starting exposure is fixed.

However, when used in an operation that starts exposure during image output (overlap readout operation),

Depending on the input timing of the trigger, the exposure start line may appear as line noise.

## 7. Partial Scan Mode

- It is possible to set the partial area with serial communication commands.

### Partial Scan Settings

Partial Scan Start Position                      Address : 40 - 41  
Partial Scanning Number of Effective Lines      Address : 50 - 51

### Configuration Examples

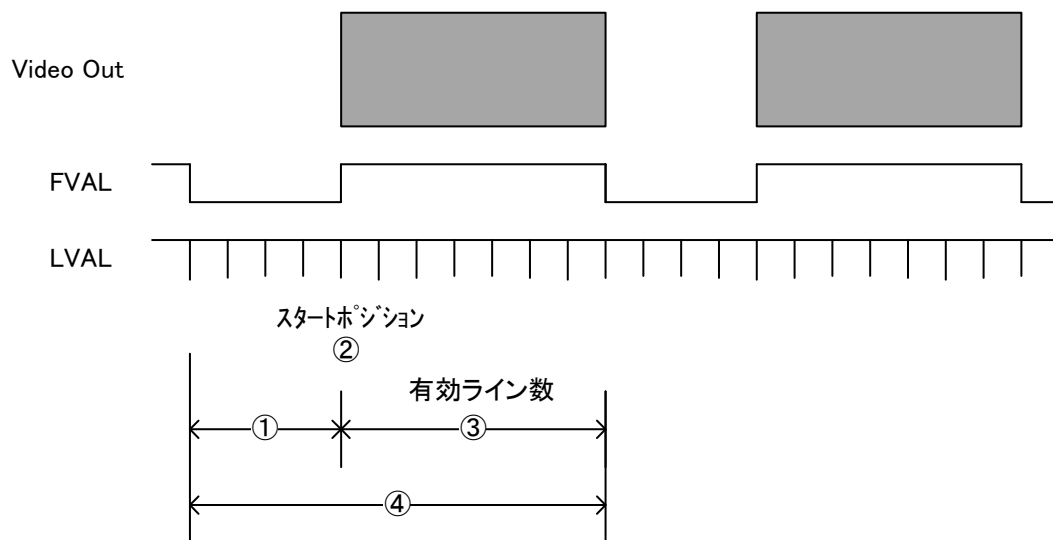

- ① : V-Blanking number                      : 42H Fixed
- ② : Partial Scan Starting Position            : 120H
- ③ : Partial Scan Number of Effective Lines   : 240H
- ④ : Total number of lines in frames        : 282H(①+③)

For the partial start position and partial area, set the **value to 4 x n**.

Total number of lines in frames

= **V Number of blanking lines (fixed at 42H)** + Number of Partial Scan effective lines

However, partial scanning must satisfy the number of valid lines <= **544** .

Frame rate = 1 / (total number of lines in frames × time of 1 line)

1 line time =

2Tap Base Configuration : 5.333us

2Tap Base Configuration (HS Mode) : 4.364us

3Tap Base Configuration (HS Mode) : 3.259us

Examples

Number of Effective Lines	frame Total number of lines	Frame Rate		
		2Tap Base Configuration	2Tap Base Configuration (HS)	3Tap Base Configuration (HS)
4H (minimum).	46H	4076.1fps	4981.8fps	6669.9fps
.				
60H	102H	1838.2fps	2246.7fps	3008.02fps
.				
120H	162H	1157.4fps	1414.6fps	1893.9fps
.				
240H	282H	664.89fps	812.64fps	1088.01fps
.				
480H	522H	359.19fps	439.01fps	587.77fps
.				
544H (Max: Full Frame)	586H	319.96fps	391.06fps	523.58fps



8. 8bit HS mode (High Speed Mode)

- High frame rate : 2Tap Base Configuration **391.06fps**, 3Tap Base Configuration **523.58fps**
- Compared to the normal 8-bit, 10-bit, and 12-bit output, the amount of saturated signal of the image sensor is 1/4.
- Compared to the normal 8bit/10bit/12bit output, the sensitivity level output from the camera is 4 times higher, and **the signal-to-noise ratio is 4 times worse.**

2Tap Base Configuration	8bit / 10bit / 12bit	319.96 fps
	<b>8bit (HS mode)</b>	<b>391.06 fps</b>
3Tap Base Configuration	<b>8bit (HS mode)</b>	<b>523.58 fps</b>

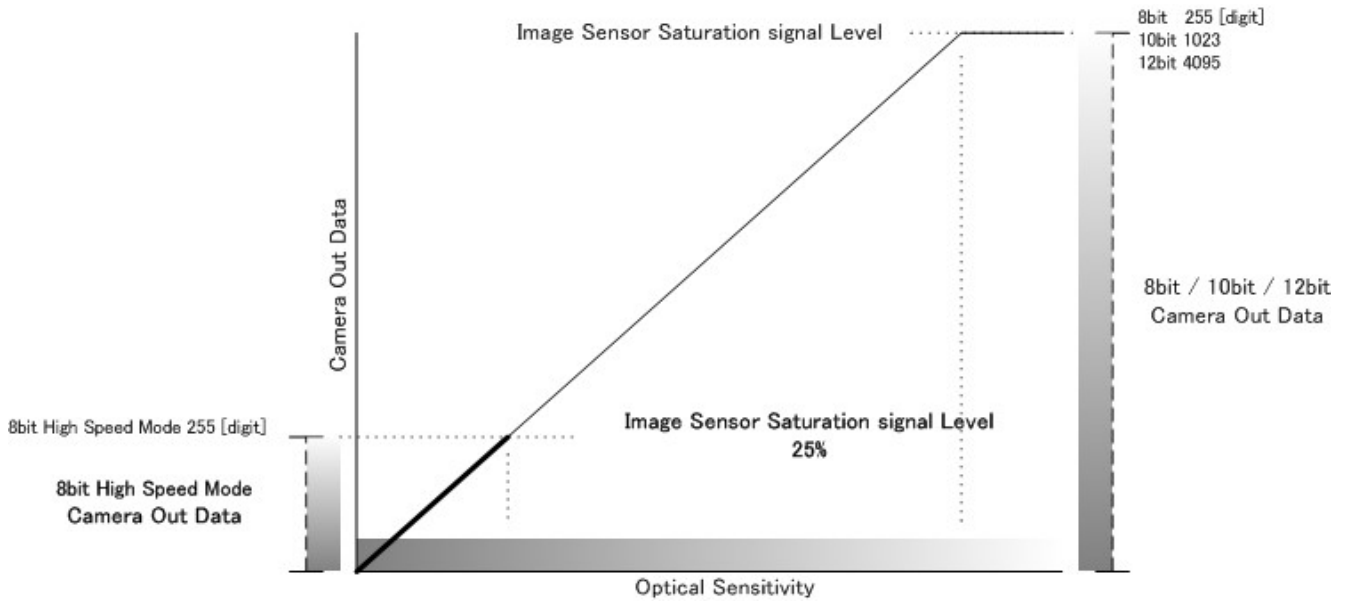

9. Serial communication function

Communication settings	
baud rate	: 9600bps (Default)
data	: 8bit
Stop Bits	: 1bit
parity	: none
XON/XOFF	: No control

• Transmit Command Format (Host → Camera)

Send the command and parameters with STX and ETX appended.

STX (02H)	command (2 bytes)	Parameters (ASCII code) (20H-7FH)	ETX (03H)
--------------	----------------------	--------------------------------------	--------------

• Response Format (Camera → Host)

The camera responds with control codes ACK, NAK.

If the response includes a text message, a telegram will be sent with STX and ETX appended.

ACK (06H)
--------------

... Successful completion

NAK (15H)
--------------

... Abnormal termination

STX (02H)	command (2 bytes)	Parameters (ASCII code) (2FH- 7FH)	ETX (03H)
--------------	----------------------	---------------------------------------	--------------

... Message reply

• List of commands

command	function
SR	Register Writes
GR	Register Reading
HIS	User Data Writing
GU	User Data Loading
CS	Config Save
CR	Config Store *
QM	Get a model name
QS	Serial Number Acquisition
QV	Firmware version acquisition
N	Get Error Details

\* After running the config-up store, restart the camera.

9.1. Command description

1) Register value setting

[Command] Set : Register

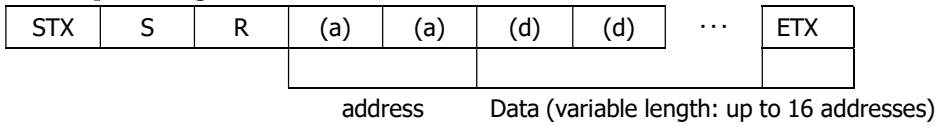

[Response]

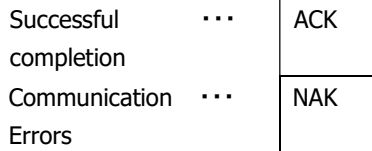

[Explanation]

Rewrites the register value at the specified address.

The data is of variable length, and you can set up to 16 addresses of data starting with the specified address.

2) Register Value Retrieval

[Command] Get: Register

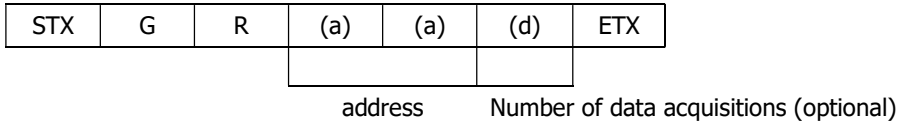

[Response]

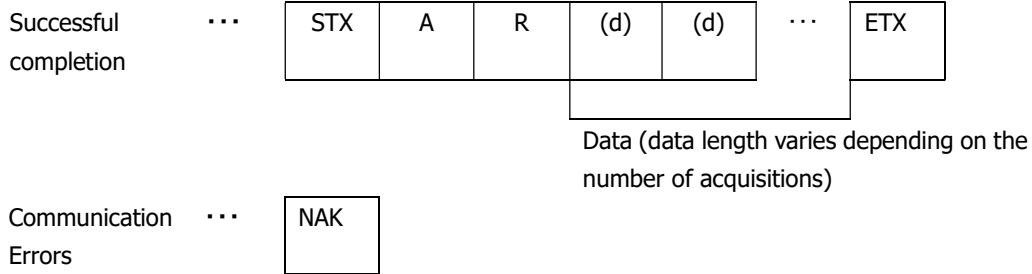

[Explanation]

Retrieves the register value for the specified address. The number of data acquisitions is specified as '0'~'F' (hexadecimal). If the number of acquisitions is set to '0', data for 16 addresses will be sent, and if omitted, data for 1 address will be sent.

3) User data settings

[Command] Light: User data

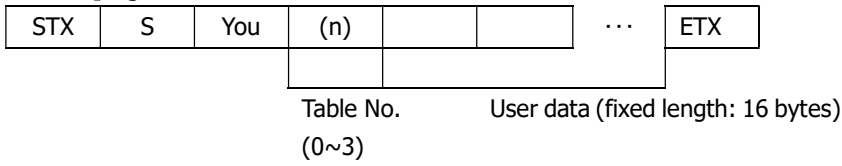

[Response]

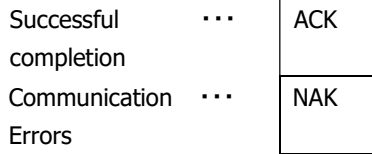

[Explanation]

The user can freely write the string. 1 table, 4 tables with 16 characters can be used.

4) User Data Acquisition

[Command] Lead: User Data

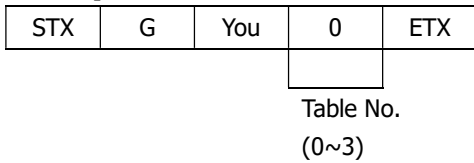

[Response]

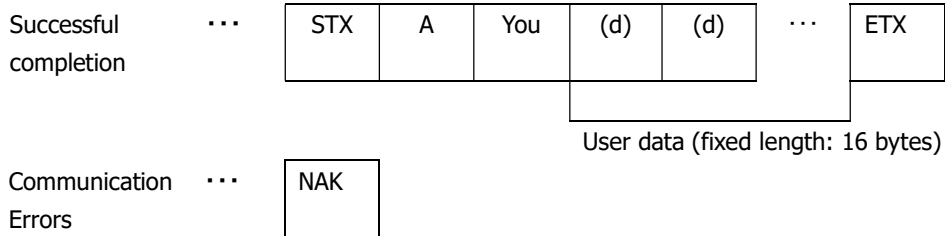

5) Register information storage

[Command] Config : Save

STX	C	S	ETX
-----	---	---	-----

[Response]

Successful completion	...	ACK
Communication Errors	...	NAK

6) Register information restoration (factory setting)

[Command] Config : Restore

STX	C	R	ETX
-----	---	---	-----

[Response]

Successful completion	...	ACK
Communication Errors	...	NAK

After executing the command, restart the camera.

7) Get Model Name

[Command] Query: Model Name

STX	Q	M	ETX
-----	---	---	-----

[Response]

Successful completion	...	STX	R	M	(d)	(d)	...	ETX	
Communication Errors	...	NAK							

Model name (fixed length: 16 bytes)

8) Serial Number Acquisition

[Command] Query: Serial Number

STX	Q	S	ETX
-----	---	---	-----

[Response]

Successful completion	...	STX	R	S	(d)	(d)	...	ETX
Communication Errors	...	NAK						

Serial number (fixed length: 8 bytes)

---

---

Errors

9) Firmware version acquisition

[Command] Query: Version

STX	Q	V	ETX
-----	---	---	-----

[Response]

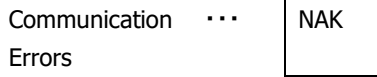
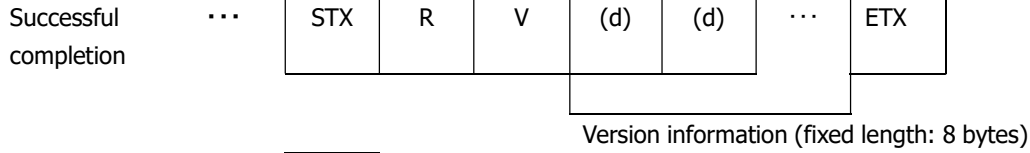

10) Get Error Details

[Command] Query: Error

STX	Q	And	ETX
-----	---	-----	-----

[Response]

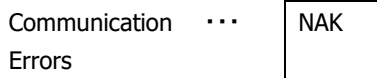
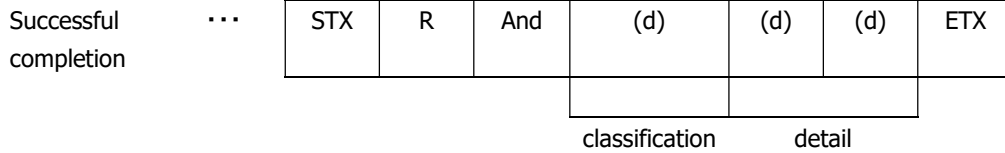

classification		detail	
0:	No Errors	00:	normal
1:	Communication Protocol Error	00:	Undefined Commands
		01:	Command Length Abnormality
		02:	Address value anomaly
		03:	Data value anomalies
		04:	Length value abnormality
		05:	Table No. Value Anomaly
		06:	User data string anomaly
2:	Internal control error	00:	Internal control fault
		01:	Write to read-only address
		02:	Write to write-protect address
		03:	Out-of-control access
		04:	Abnormal in the selected table number
		05:	There is an abnormality in the set value of the average value acquisition area.
		06:	Feature not implemented

---

---

## 9.2. Control example

- 1) Check the status of the trigger shutter mode. (Lead address 04)

[Send Command]

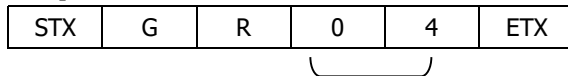

Address 04

[Camera response]

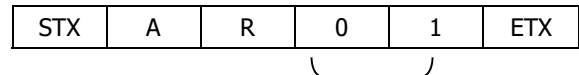

Data 01

[Response received]

Since the 01 was answered, the fixed trigger shutter mode.

- 2) Examine the manual gain settings. (Read 2 consecutive bytes from address 20)

[Send Command]

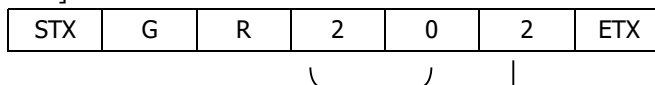

Address 20 2 bytes

[Camera response]

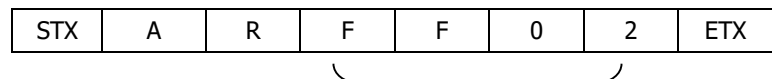

Data 02FF

[Response received]

02FF (767) was replied to, so +12dB.



---

---

3) Set to partial scan mode. (Write 01 to 08)

[Send Command]

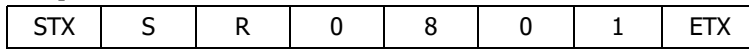

Address 08 Data 01



[Camera response]

ACK



[Response received]

The ACK was answered, so the configuration was successful.

4) Set the manual shutter value to 01FF. (Write 24FF to address 01)

[Send Command]

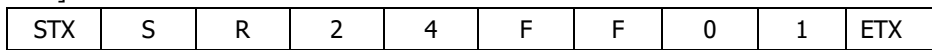

Address 24 Data 01FF



[Camera response]

ACK



[Response received]

The ACK was answered, so the configuration was successful.

---

---

5) Save the camera settings. (Send CS command)

[Send Command]

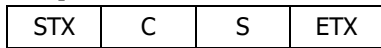

[Camera response]



[Response received]

The ACK was answered, so the configuration was successful.

6) Restore the camera to factory settings. (Send CR command)

[Send Command]



[Camera response]



[Response received]

The ACK was answered, so the configuration was successful.

---

---

7) Get the details of a communication error.

[Send Command]

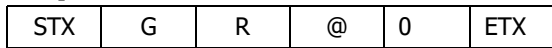

Illegal string in the address



[Camera response]



[Response received]

NAK was replied to, and the command terminated abnormally.

Resend the command or make an error details request.

[Send Command]

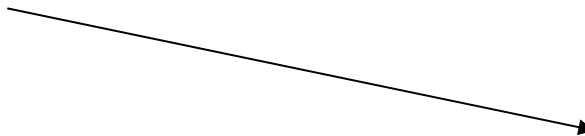

[Camera response]

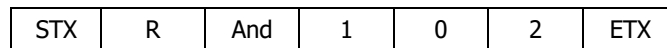

Type 1 Detail02



[Response received]

Type 1, Detail 02 was replied to, so an address value abnormal error occurred.

10. Function setting (Sets the function of the camera using serial communication. )

function	Address (Hex)	Data (Hex)			
Preset Shutter	01		2Tap Base Configuration	2Tap Base Configuration (HS)	3Tap Base Configuration (HS)
		00:	1/320s(OFF)	1/391s(OFF)	1/523s(OFF)
		01:	1/500s	1/500s	1/750s
		02:	1/750s	1/750s	1/1000s
		03:	1/1000s	1/1000s	1/2500s
		04:	1/2500s	1/2500s	1/5000s
		05:	1/5000s	1/5000s	1/7500s
		06:	1/7500s	1/7500s	1/10000s
		07:	1/10000s	1/10000s	1/20000s
		08:	1/20000s	1/20000s	1/30000s
		09:	1/24000s	1/28000s	1/33000s
		0A:	1/28000s	1/32000s	1/37000s
		0B:	1/33000s	1/37000s	1/42000s
		0C:	1/40000s	1/44000s	1/48000s
		0D:	1/51000s	1/54000s	1/57000s
		0E:	1/51000s	1/54000s	1/57000s
0F:	Manual shutter (see addresses 24-25)				
Preset White Balance (Color only)	02	00:	THRU		
		01:	3200K		
		02:	THRU(Spare)		
		03:	Manual White Balance		
Trigger Shutter Mode	04	00:	Normal shutter mode (trigger OFF)		
		01:	Fixed trigger shutter mode (set shutter speed at address 01)		
		02:	Pulse Width Trigger Shutter Mode		
Trigger polarity	05	00:	Positive polarity		
		01:	Negative polarity		
Trigger Input	06	00:	CC1		
		01:	12pin connector 11pin input		
Slow shutter	07	0 - FF:	min:0(0H) - max:255(FFH) 0: OFF, 255: +255 frame time 1 frame = 2Tap Base Configuration : 3.125ms 2Tap Base Configuration (HS) : 2.557ms 3Tap Base Configuration (HS) : 1.9099ms * In partial scan mode, the total number of frames set for several hours is the frame time.		
Partial Scan Mode	08	00:	Full Frame Scan Mode		
		01:	Partial Scan Mode		
Camera Output Mode (* 1)	0A	00:	2Tap Base Configuration		
		01:	3Tap Base Configuration (HS mode)		
Output bit selection	0B	00:	8-bit output		
		01:	10-bit output		
		02:	12-bit output		
		03:	8-bit HS mode output		

\*1 When changing the settings, save the data and restart the camera.

function	Address (Hex)	Data (Hex)	
baud rate (* 2)	10	00:	9600bps
		01:	19200bps
		02:	38400bps
		03:	57600bps
		04:	115200bps
Trigger Hsync Mode	17	00:	OFF
		01:	ON
Output image upside down, left and right flip	18	00:	normal
		01:	Upside down
		02:	Flip left and right
		03:	Upside down, left, right
LED ON/OFF	1B	00:	OFF
		01:	ON
Manual Gain	20-21	0 - 78:	min:0(0H) - max:120(78H) 0: x1(0dB), 120: x4(+12dB)
Manual shutter	24-25	LLHH:	Main:0(0h) - Max:570(23H)
			2Tap Base Configuration Shutter time = 14.26us + (571 - (set)) × 5.333us min:0=3.059ms(1/320s), max:570=1.959us(1/51000s)
			2Tap Base Configuration (HS) Shutter Time = 14.26us + (571 - (set)) × 4.364us min:0=2.506ms(1/391s), max:570=18.62us(1/54000s)
			3Tap Base Configuration (HS) Shutter Time = 14.26us + (571 - (set)) × 3.259us min:0=1.875ms(1/523s), max:570=17.52us(1/57000s)
Manual White Balance R (Color only)	28-29	LLHH:	min:0(0H) - max:767(2FFH) 0: x1(0dB), 767: x4(+12dB)
Manual White Balance B (Color only)	2A-2B	LLHH:	min:0(0H) - max:767(2FFH) 0: x1(0dB), 767: x4(+12dB)
Manual White Balance G (Color only)	2C-2D	LLHH:	min:0(0H) - max:767(2FFH) 0: x1(0dB), 767: x4(+12dB)
Partial Scanning Starting Position	40-41	LLHH:	min:0(0H) - max:540(21PM) * Please set the setting value to a <b>value of 4 x n.</b>
Partial Scanning Number of Effective Lines	50-51	LLHH:	min:4(4H) - max:544(220H) * When not in use, set the number of effective lines = 544 (220H). * To enable partial scanning, set the data at address 08 to 01. Please.

\*2 Changes to the settings will take effect after the camera is restarted. (Data will be saved automatically)

\* LLHH: The data to be set in 2Byte is set in the order of Low Byte Data and High Byte Data.

< Configuration Example > Setting 767 (02FFH) for Manual Gain (Addresses 24-25)

STX SR 24 FF 02 ETX

11. Dimensions

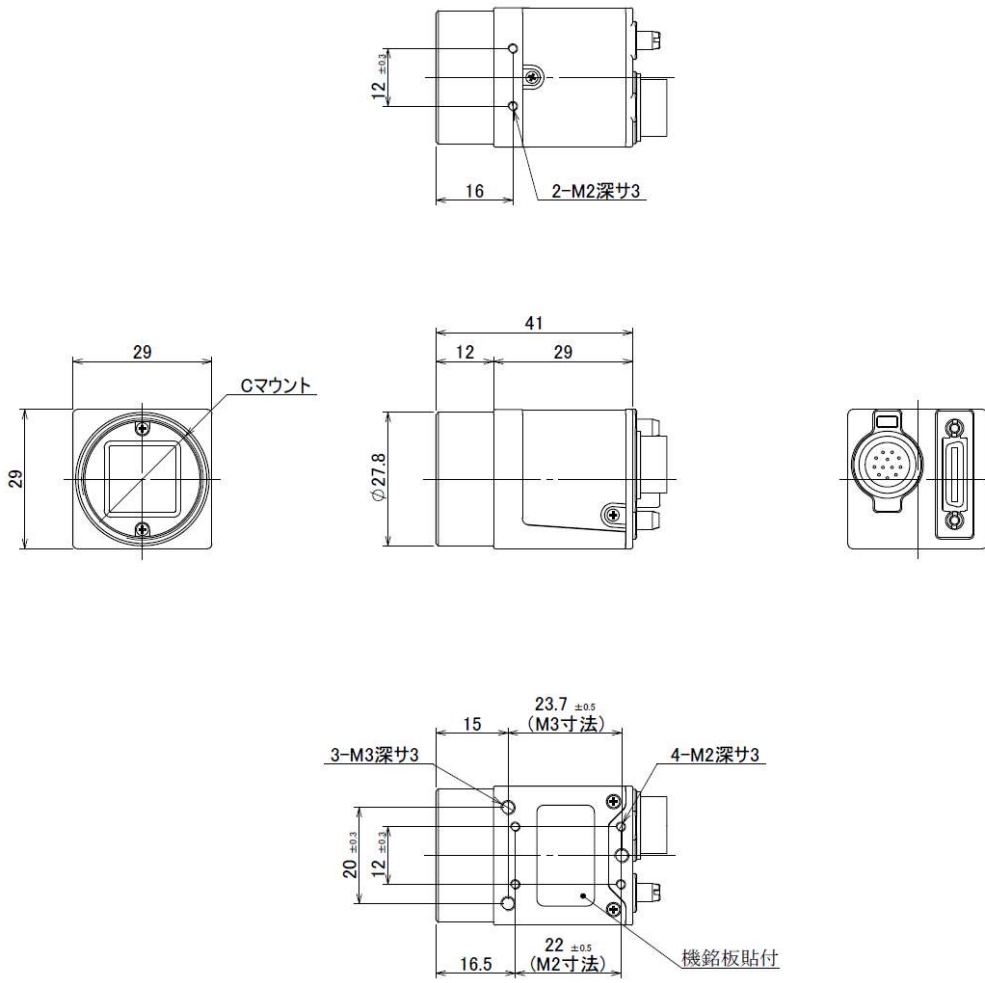

(Unit: mm)

## 12. Factory Settings

function	address	data	
Preset Shutter	01	00:	1/320s(OFF)
Preset White Balance (Color Only)	02	00:	THRU
Trigger Shutter Mode	04	00:	Normal shutter mode (trigger OFF)
Trigger polarity	05	00:	Positive polarity
Trigger Input	06	00:	CC1
Slow shutter	07	00:	OFF
Partial Scan Mode	08	00:	Full Frame Scan Mode
Camera Output Mode	0A	00:	2Tap Base Configuration
Output bit selection	0B	00:	8-bit output
baud rate	10	00:	9600bps
Trigger Hsync Mode	17	01:	ON
Output image up, down, left and right reverse rollers	18	00:	normal
LED ON/OFF	1B	01:	ON
Manual Gain	20-21	0000:	0dB
Manual shutter	24-23	0000:	Shutter (OFF)
Manual White Balance R (Color Only)	28-29	0000:	0dB
Manual White Balance B (Color Only)	2A-2B	0000:	0dB
Manual White Balance G (Color Only)	2C-2D	0000:	0dB
Partial Scan Start Position	40-41	0000:	Starting Position 0
Number of Partial Scan Effective Lines	50-51	0220:	Number of effective lines: 544

---

---

### 13. Warranty Coverage

The warranty period of this product is 3 years from the date of shipment by our company.

During this period, if a failure occurs due to our design or manufacturing, we will repair it free of charge in accordance with the 15th product service.

However, due to negligence in handling by the customer, natural disasters such as fire, earthquake, lightning, wind and flood damage, or other force majeure.

Damage or malfunction is not covered by the warranty.

Repairs after the warranty period has elapsed will be repaired for a fee only if it can be repaired.

### 14. About CMOS pixel defects

Pixel defects that are noticeable at the time of product shipment are corrected and shipped, but after the product is shipped, the image sensor-specific

Depending on the characteristics, new pixel defects may occur, and some defect levels may increase over time.

This is excluded from the product warranty.

For details of pixel defect correction, please contact our sales department.

### 15. Product Services

If the product does not work properly due to any factor after purchasing the product, please contact the dealer where you purchased it for investigation, analysis, and repair.

Please contact us.