

12M CMOS Camera

ID12MB-CL (B/W)

ID12MC-CL (Color)

Technical Manual

Table of Contents

	PAGE
1. Product Outline	3
2. Handling Precautions	3
3. Specification	3
3.1. General Specification.....	4
3.2. Camera Output Signal Specification	5
3.3. Spectral Response (Representative Value).....	6
4. Connector	7
4.1. Camera Link Connector 12226-1100-00PL (SUMITOMO 3M).....	7
4.2. Power LED	8
4.3. 12pin Connector HR10-10R-12PA(73) (HIROSE) (CN3)	8
4.4. Power Select (SW1).....	8
5. Timing Chart	9
5.1. Horizontal Synchronous Signals Timing (2Tap Base Configuration : 11fps)	9
5.2. Vertical Synchronous Signals Timing (2Tap Base Configuration : 11fps).....	9
5.3. Horizontal Synchronous Signals Timing (4Tap Medium Configuration : 22fps).....	10
5.4. Vertical Synchronous Signals Timing (4Tap Medium Configuration : 22fps).....	10
5.5. Horizontal Synchronous Signals Timing (8Tap Full Configuration : 42fps) Initial Setting	11
5.6. Vertical Synchronous Signals Timing (8Tap Full Configuration : 42fps) Initial Setting.....	11
5.7. Video Output Format	12
5.8. Fixed Trigger Shutter Mode	13
5.9. Pulse Width Trigger Shutter Mode.....	14
6. Partial Scan Mode	15
7. Remote Communication	17
7.1. Command Specifications	18
7.2. Control Example.....	22
8. Function Setting	26
9. CMOS Optical Axis Accuracy	30
10. Dimensions	31
11. ID-M42F (M42 P1-F Mount Adaptor) *Option	32
12. Initial Setting	33
13. Cases for Indemnity (Limited Warranty)	34
14. CMOS Pixel Defect	34
15. Product Support	34

1. Product Outline

ID12MB-CL/ID12MC-CL is a Camera Link interfaced and 12M resolution camera module. 12M pixels CMOS sensor with diagonal length 28.160mm is utilized. Entire pixels can be read out within 1/42s at Full Configuration output.

Features

- Global Shutter CMOS sensor is utilized.
- Camera Link Base , Medium, Full Configuration are supported.
- Fixed trigger shutter mode, pulse width trigger shutter mode are operable.
- Full frame rates are as follows.

2Tap Base Configuration	11fps	8bit/10bit
4Tap Medium Configuration	22fps	8bit/10bit
8Tap Full Configuration*	42fps	8bit

*Initial Setting : 8Tap Full Configuration (42fps, 8bit)

2. Handling Precautions

The camera must not be used for any nuclear equipment or aerospace equipment with which mechanical failure or malfunction could result in serious bodily injury or loss of human life. Our warranty does not apply to damages or defects caused by irregular and /or abnormal use of the product.

Please observe all warnings and cautions stated below.

Our warranty does not apply to damages or malfunctions caused by neglecting these precautions.

Do not use or store the camera in the following extreme conditions :

- Extremely dusty or humid places.
 - Extremely hot or cold places (operating temperature -5°C to +45°C).
 - Close to generators of powerful electromagnetic radiation such as radio or TV transmitters.
 - Places subject to fluorescent light reflections.
 - Places subject to unstable (flickering, etc.) lighting conditions.
 - Places subject to strong vibration.
-
- Remove dust or dirt on the surface of the lens with a blower.
 - Do not apply excessive force or static electricity that could damage the camera.
 - Do not shoot direct images that are extremely bright (e.g., light source, sun, etc.), and when camera is not in use, put the lens cap on.
 - Confirm the mutual ground potential carefully and then connect the camera to monitors or computers. AC leaks from the connected devices may cause damages or destroy the camera.
 - Do not apply excessive voltage. (Use only the specified voltage.) Unstable or improper power supply voltage may cause damages or malfunction of the camera.
 - The voltage ripple of camera power DC +12V±10% shall be within ±50mV. Improper power supply voltage may cause noises on the video signals.
 - The rising time of camera power supply voltage shall be less than +10V, Max 60ms. Please avoid noises like chattering when rising.

3. Specification

3.1. General Specification

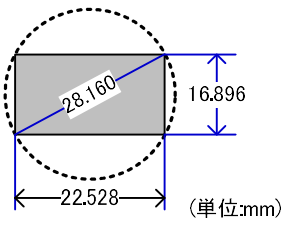
(1) Image Sensor	Device type	Diagonal length 28.160mm, Global Shutter type (CMOSIS CMV12000)	
	Effective pixel number	4096(H) x 3072(V)	
	Unit cell size	5.5 μ m(H) x 5.5 μ m(V)	
	Image circle	ϕ 28.160mm	
			
(2) Video Output Frequency	Pixel Clock	68MHz	
	Output effective pixel number	4096(H) x 3072(V)	
	2Tap Base Configuration	11fps	4128(H) x 1552(V) with blanking
	4Tap Medium Configuration	22fps	2064(H) x 1552(V) with blanking
	8Tap Full Configuration	42fps	1032(H) x 1552(V) with blanking
(3) Video Output	2Tap Base Configuration		
	4Tap Medium Configuration		
	8Tap Full Configuration (Initial Setting)		
(4) Output Format	Sensor AD	10bit	
	Camera Link Output	8bit / 10bit	
(5) Sensitivity	B/W	F11	2000lx
	Color	F11	2000lx
(at shutter speed 1/42s (OFF), Gain 0dB, Full Configuration mode)			
(6) Minimum Illumination	B/W	F1.4	1.0lx
	Color	F1.4	1.0lx
(at shutter speed 1/42s (OFF), Gain+12dB, Full Configuration mode)			
(7) Power Requirements	12 pin connector (Initial Setting) / PoCL		
(8) Power Consumption	max 3.5W (at 2Tap Base Configuration)		
	max 4.0W (at 4Tap Medium Configuration)		
	max 4.5W (at 8Tap Full Configuration)		
(9) Dimensions	H:55mm W:55mm D:30mm excluding projection		
(10) Weight	Approx. 120g		
(11) Lens Mount	M42 P1 mount		
(12) Optical Axis Accuracy	Refer to drawing for CMOS optical axis accuracy		
(13) Gain Variable Range	0dB ~ +12dB (Guaranteed range)		
(14) Shutter Speed Variable Range	OFF(1/11s) ~ 1/9500s (2Tap Base Configuration)		
	OFF(1/22s) ~ 1/13000s (4Tap Medium Configuration)		
	OFF(1/42s) ~ 1/17000s (8Tap Full Configuration)		
(15) Trigger Shutter Mode	Fixed shutter trigger mode / Pulse width shutter trigger mode		
(16) Partial Scan	Full frame ~ 4Line (4Line/Step) Max 32 areas		
	*Start position and Effective line : Even number only		
(17) Safety/Quality Standards	UL : Conform to UL Standard including materials and others.		
	CE :	To be applied for EN55022:2006 Class B for Emission06	
		To be applied for EN61000-6-2:2005 for Immunity	
	RoHS:Conform to RoHS		
(18) Durability	Vibration	20~200 Hz,98m/s ² (10G), X,Y and Z 3directions (120 min for each direction)	
	Shock	No malfunction shall be occurred with 980m/s ² (100G) for \pm X, \pm Y,and \pm Z, 6 directions. (without package)	
(19) Operation Environment	Temperature	-5 ~ +45°C	
	Humidity	20 ~ 80%RH with no condensation.	
(20) Storage Environment	Temperature	-25 ~ +60°C Humidity 20 ~ 80%RH with no condensation.	

3.2. Camera Output Signal Specification

(1)Video Output Data	Effective Video Output	4096(H) × 3072(V)	(at Full Frame Scan Mode)
(2)Sync Signal Output	LVAL FVAL DVAL SP	Camera Link (LVDS)	
	LVAL FVAL	12pin Connector 6pin (LVC) 12pin Connector 7pin (LVC)	
(3)Camera Control Signal Input	CC2·CC3·CC4	Camera Link (LVDS)	(No Function)
(4)Trigger Input	Polarity	Positive/Negative Selectable	(Address 05)
	Pulse Width	2HD(Min)* ~ Approx.2 frames ·2Tap Base Configuration : 1HD (60.706us) ·4Tap Medium Configuration : 1HD (30.353us) ·8Tap Full Configuration : 1HD (15.176us) *2HD<45.205us -> Max 45.205us Functionally, no upper limitation is set but noises such as dark noises and shadings might be noticeable at long time exposure.	
	CC1(Trigger Input) 12pin Connector(Trigger Input)	Camera Link (LVDS) 12pin Connector 11pin Input (LVC)	(Address 06)
(5)Serial Communication	SerTC SerTFG	Camera Link (LVDS)	(Serial to Camera) (Serial to Frame Grabber)
(6)Video Signals	White Clip Level	3FFh	(at Gain 0dB, 10bit)
	Setup Level	under 002h	
	Dark Shading	Both horizontal and vertical should be under 00Fh	

3.3. Spectral Response (Representative Value)

ID12MB-CL (B/W)

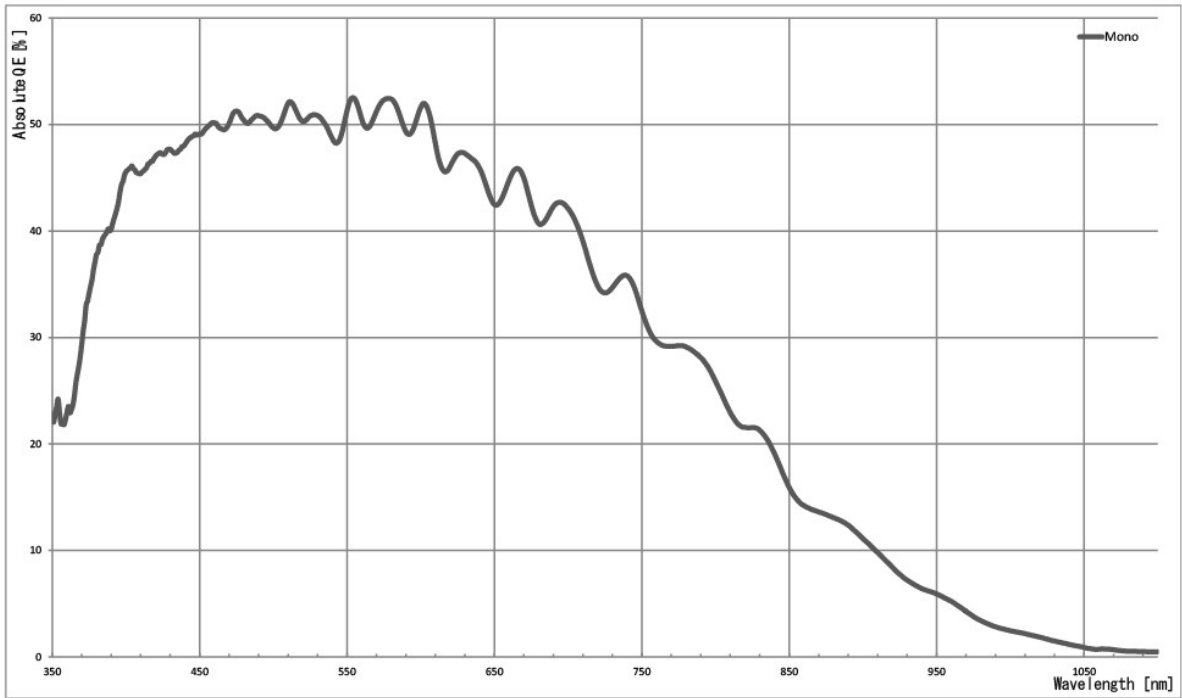

ID12MC-CL (Color)

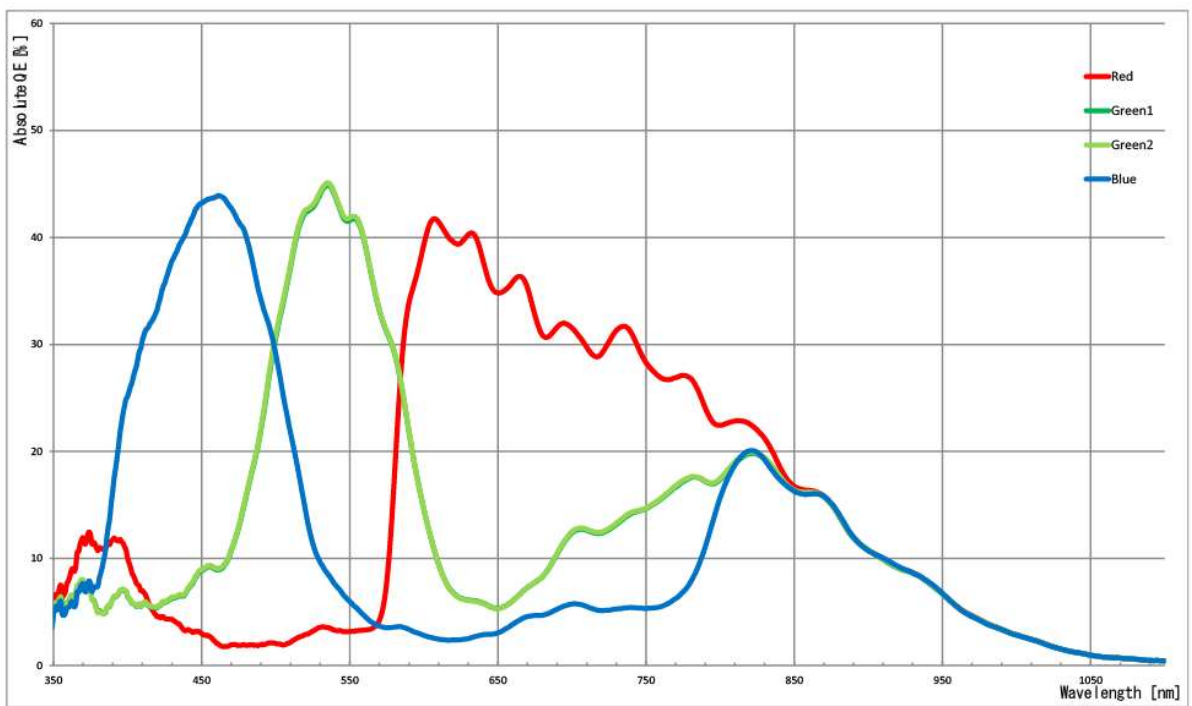

4. Connector

4.1. Camera Link Connector 12226-1100-00PL (SUMITOMO 3M)

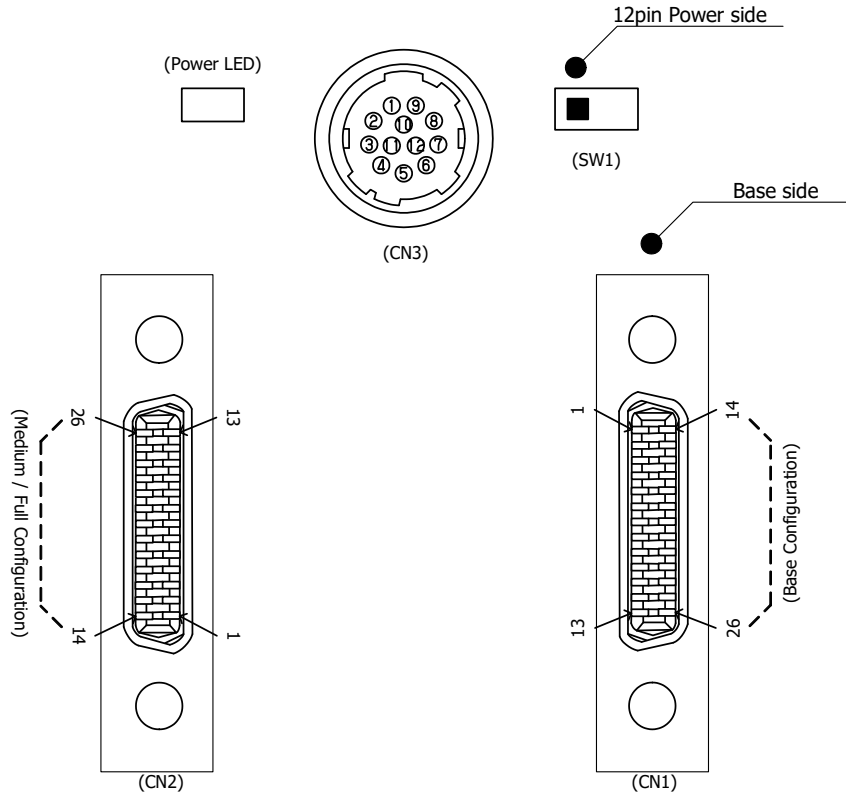

Connector (CN2)

Pin No		Pin No	
1	NC	14	GND
2	Y0-	15	Y0+
3	Y1-	16	Y1+
4	Y2-	17	Y2+
5	Yclk-	18	Yclk+
6	Y3-	19	Y3+
7	100Ω	20	Terminated
8	Z0-	21	Z0+
9	Z1-	22	Z1+
10	Z2-	23	Z2+
11	Zclk-	24	Zclk+
12	Z3-	25	Z3+
13	GND	26	NC

Connector (CN1)

Pin No		Pin No	
1	+12V(PoCL)	14	GND
2	X0-	15	X0+
3	X1-	16	X1+
4	X2-	17	X2+
5	Xclk-	18	Xclk+
6	X3-	19	X3+
7	SerTC+	20	SerTC-
8	SerTFG-	21	SerTFG+
9	CC1- (Trigger IN -)	22	CC1+ (Trigger IN +)
10	CC2+	23	CC2-
11	CC3-	24	CC3+
12	CC4+	25	CC4-
13	GND	26	+12V(PoCL)

4.2. Power LED

Camera turns on LED light, when it is supplied electricity from the frame Grabber board.

*Power feeding line of CN1 (on Base Configuration connector side) will be connected to the camera internal power input. At this time, power feeding line of CN2 (on Medium/Full Configuration connector side) shall be OPEN. When using at Medium /Full Configuration mode, please contact the frame grabber board manufacturer to make sure that there would be no problem with the above connection.

4.3. 12pin Connector HR10-10R-12PA(73) (HIROSE) (CN3)

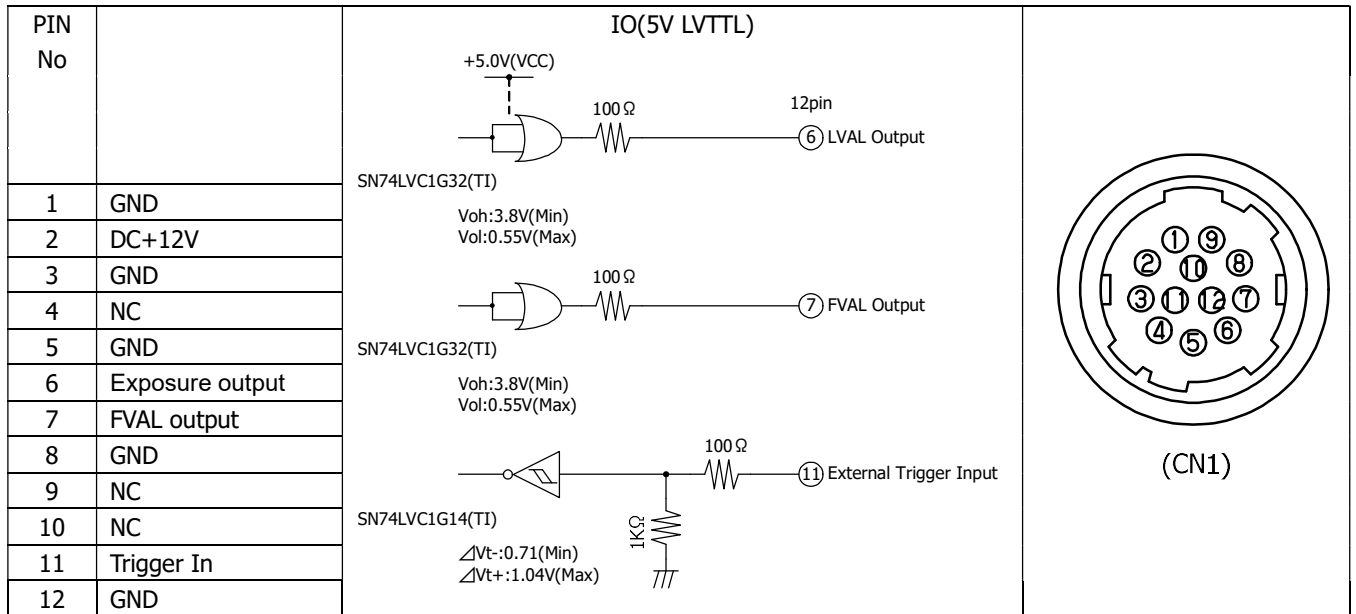

4.4. Power Select (SW1)

(1) 12pin Connector (Initial Setting)

Set the switch when using non-PoCL supported frame grabber board.
Please make sure that the power of feeding side is OFF when changing the switch setting.
If the switch setting is changed while power distribution, malfunction may occur.

(2) PoCL

Set the switch when feeding power via the frame grabber board with PoCL supported.

When the switch is set to PoCL side, power feeding line of CN1 (on Base Configuration connector side) will be connected to the camera internal power input. At this time, power feeding line of CN2 (on Medium/Full Configuration connector side) shall be OPEN. When using at Medium/Full Configuration mode, please contact the frame grabber board manufacturer to make sure that there would be no problem with the above connection.

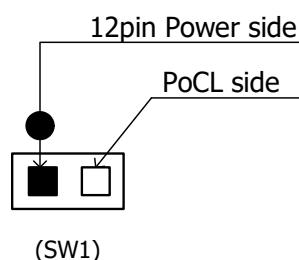

5. Timing Chart

5.1. Horizontal Synchronous Signals Timing (2Tap Base Configuration : 11fps)

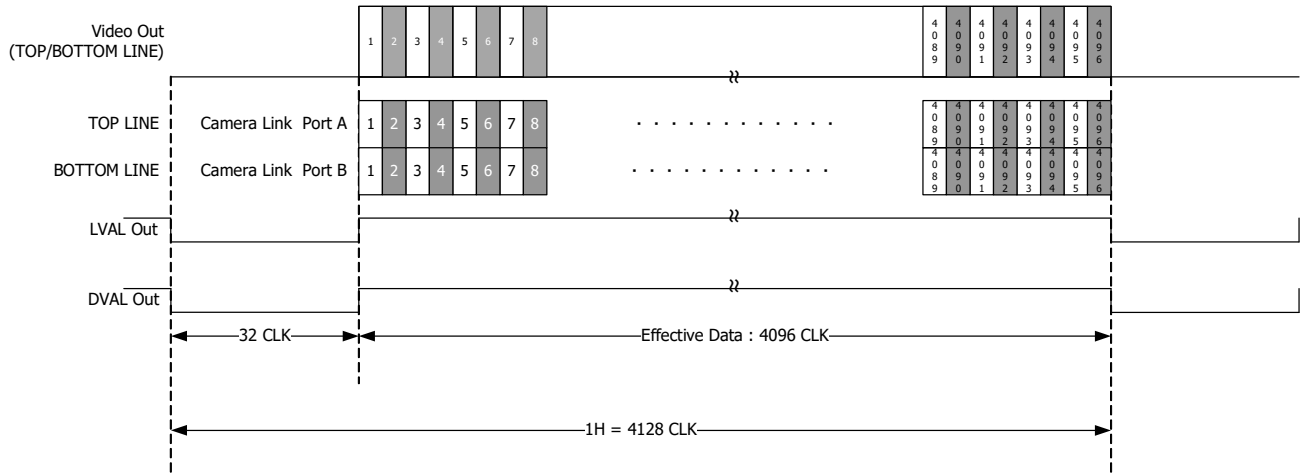

Camera Link CLK : 68MHz

5.2. Vertical Synchronous Signals Timing (2Tap Base Configuration : 11fps)

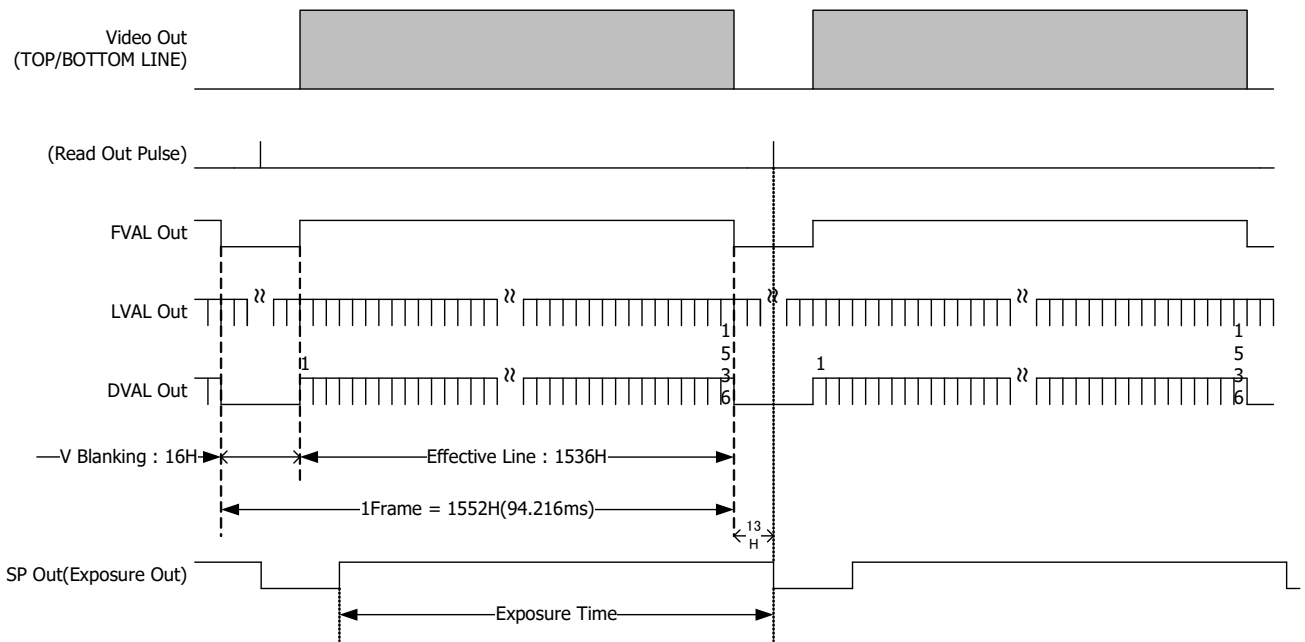

1H = 60.706us

5.3. Horizontal Synchronous Signals Timing (4Tap Medium Configuration : 22fps)

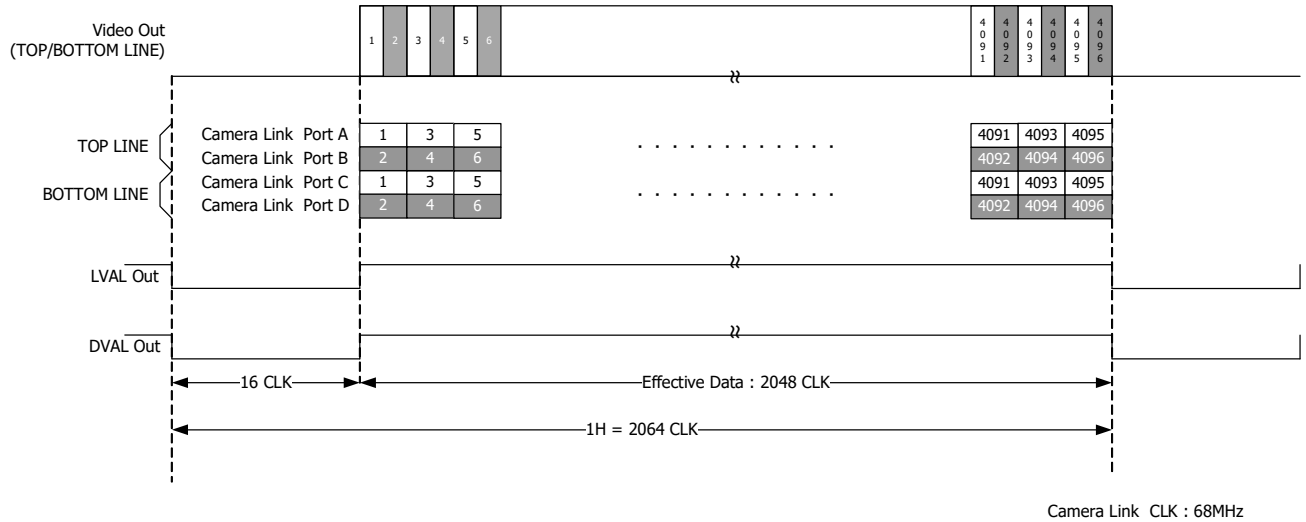

5.4. Vertical Synchronous Signals Timing (4Tap Medium Configuration : 22fps)

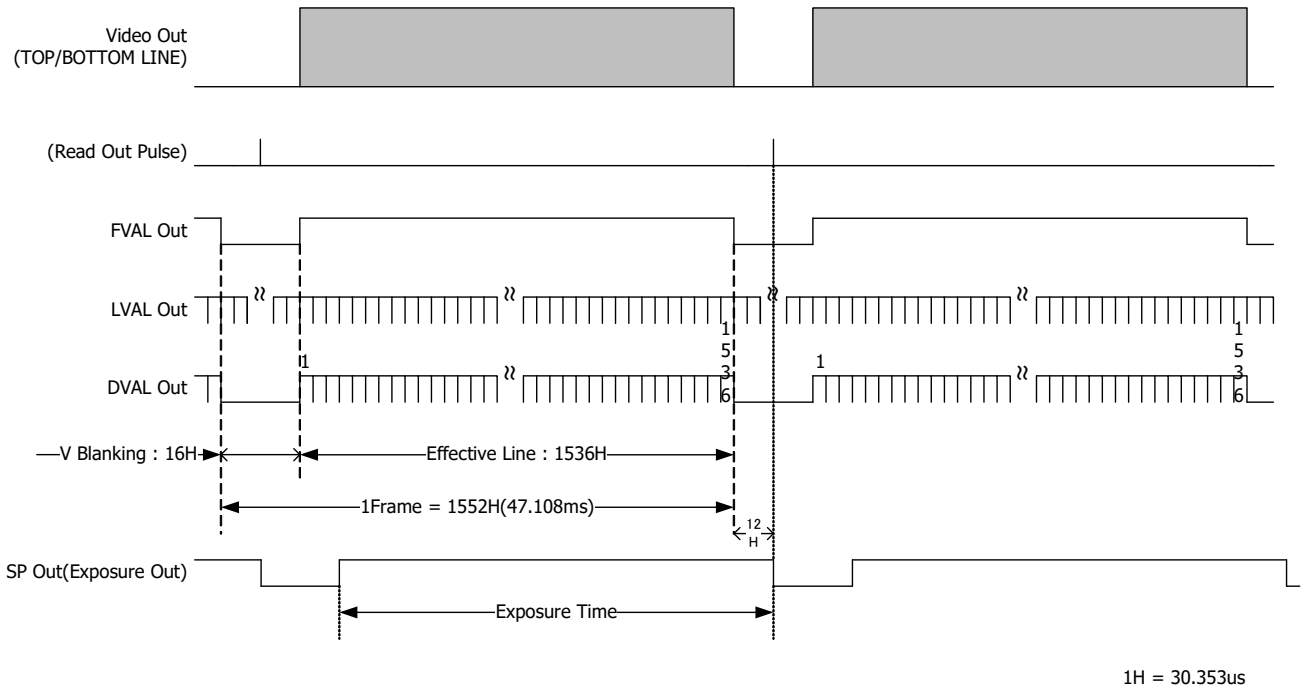

5.5. Horizontal Synchronous Signals Timing (8Tap Full Configuration : 42fps) Initial Setting

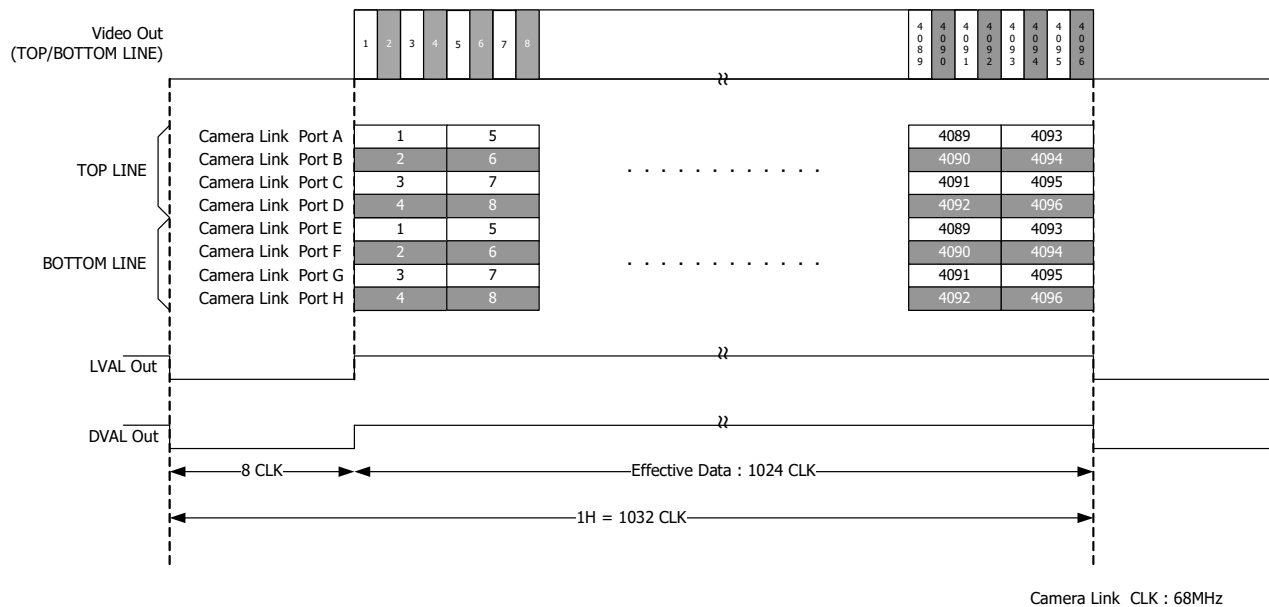

5.6. Vertical Synchronous Signals Timing (8Tap Full Configuration : 42fps) Initial Setting

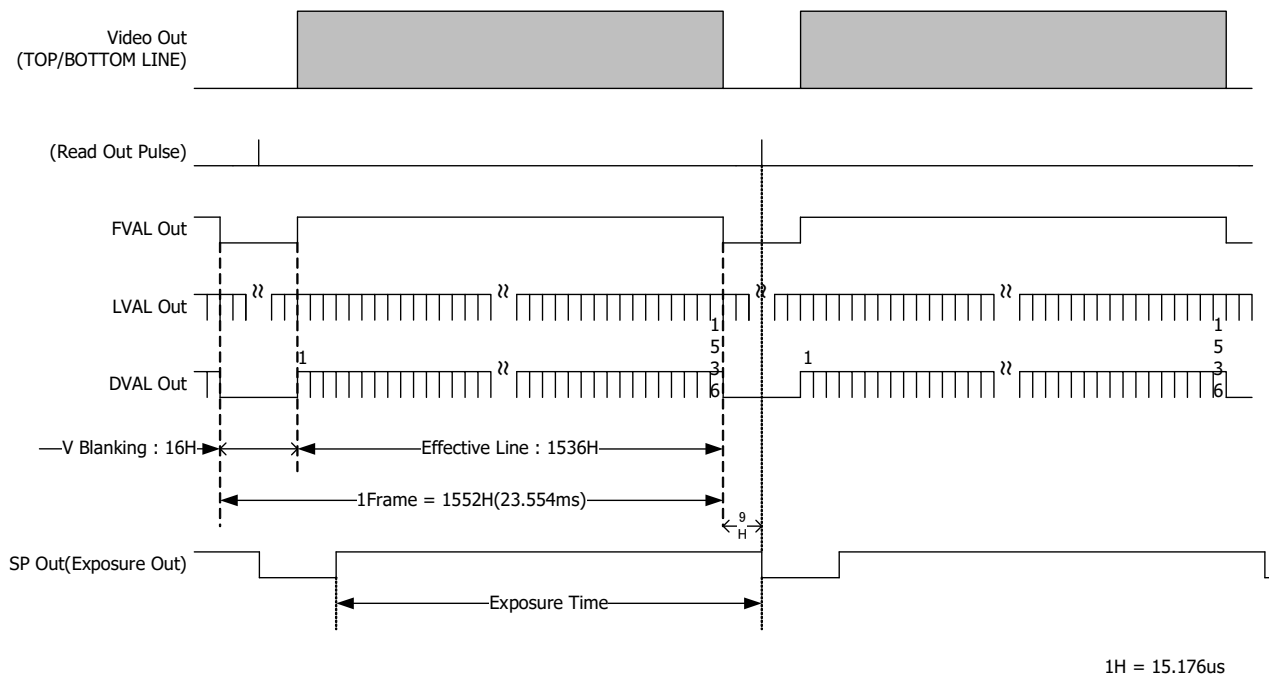

5.7. Video Output Format

(1) 2Tap Base Configuration : 11fps

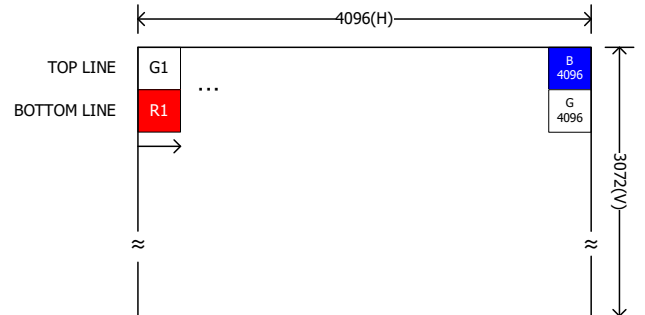
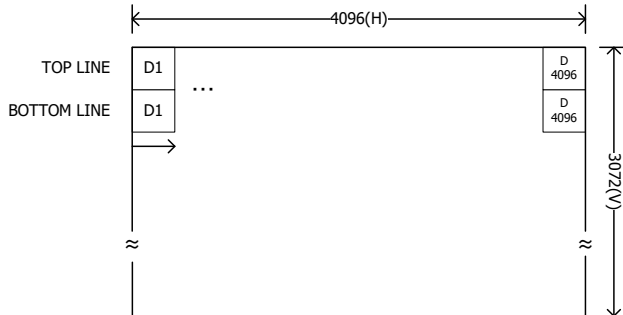

(2) 4Tap Base Configuration : 22fps

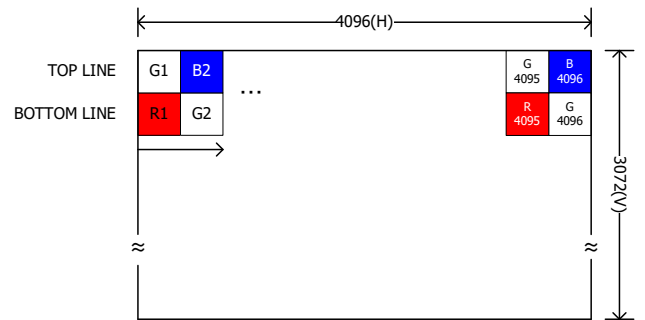
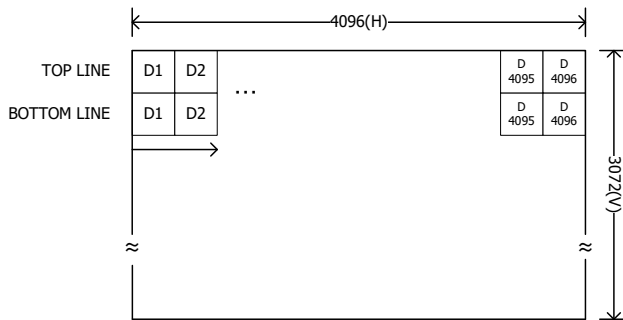

(3) 8Tap Full Configuration : 42fps (Initial Setting)

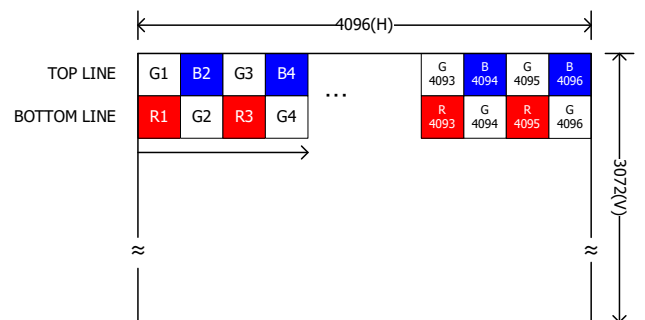
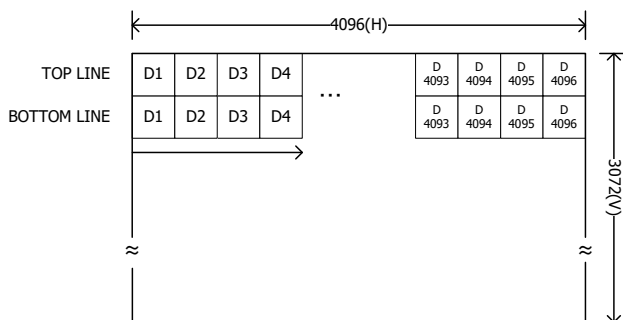

5.8. Fixed Trigger Shutter Mode

- This is the mode to start exposure with external input trigger signals, and set the exposure time with serial commands.
- Delay time (Exposure Time Delay) from detecting trigger edge in the camera to starting exposure.

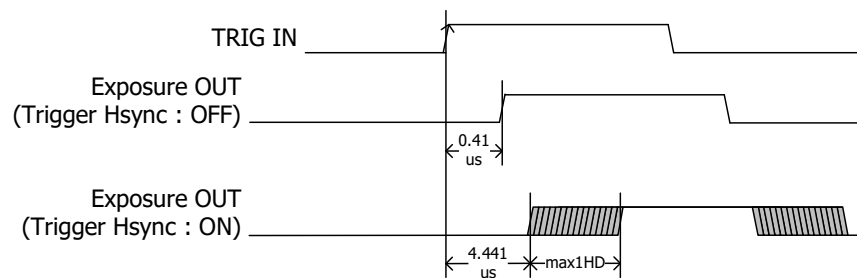

- (1) Trigger Hsync Mode ON : $4.441\mu\text{s} + \text{max 1HD}$
 - 2Tap Base Configuration $4.441\mu\text{s} + \text{max 1HD}$ (60.706 μs)
 - 4Tap Medium Configuration $4.441\mu\text{s} + \text{max 1HD}$ (30.353 μs)
 - 8Tap Full Configuration $4.441\mu\text{s} + \text{max 1HD}$ (15.176 μs)
- (2) Trigger Hsync Mode OFF : 0.41 μs fixed

- Triggers can be accepted even when outputting video signals.
However, trigger signals for exposure to start the next video output prior to the completion of video transmission for the prior video output signals can not be accepted.
- Trigger input during exposure time should be ignored. (Refer to the below A)

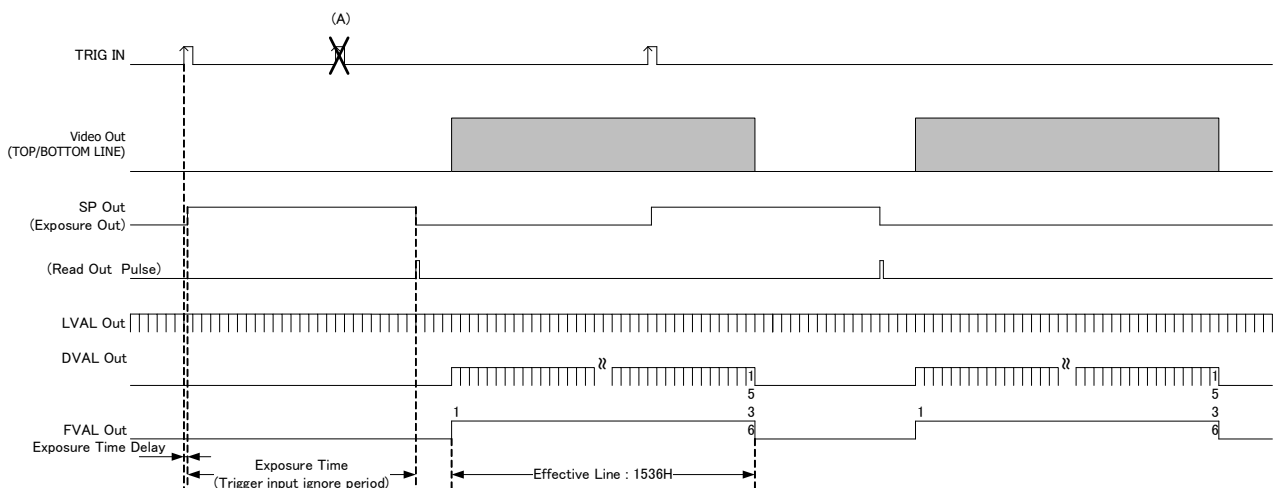

- The delay time is fixed with the Trigger Hsync Mode ON.
However, if you use inputting the trigger signals for exposure to start the next video output prior , the line noise appears occasionally by the trigger timing.

5.9. Pulse Width Trigger Shutter Mode

- This is the mode to start exposure with external input trigger signals, and set the exposure time with pulse width of the trigger signals.
- Delay time (Exposure Time Delay) from detecting trigger edge in the camera to starting exposure, and from detecting trigger end edge to completing exposure.

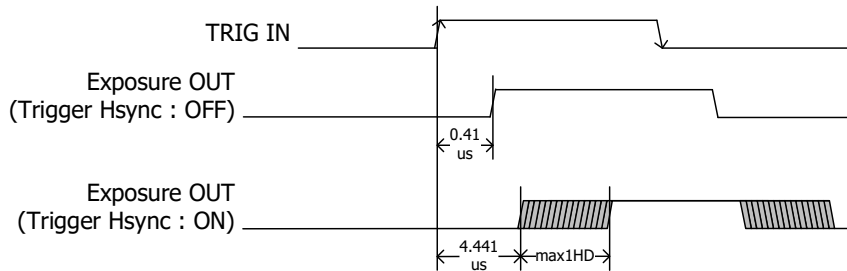

- (1) Trigger Hsync Mode ON : $4.441\mu\text{s} + \text{max 1HD}$
 - 2Tap Base Configuration $4.441\mu\text{s} + \text{max 1HD}$ (60.706 μs)
 - 4Tap Medium Configuration $4.441\mu\text{s} + \text{max 1HD}$ (30.353 μs)
 - 8Tap Full Configuration $4.441\mu\text{s} + \text{max 1HD}$ (15.176 μs)
- (2) Trigger Hsync Mode OFF : 0.41 μs fixed

- Pulse width is min. 2HD (min) to approx. 2 frames.
Functionally, there is no upper limitation, but noises such as dark noises and shadings may be noticeable at long time exposure.

- Triggers can be accepted even when outputting video signals.
However, trigger signals for exposure to start the next video output prior to the completion of video transmission for the prior video output signals can not be accepted.

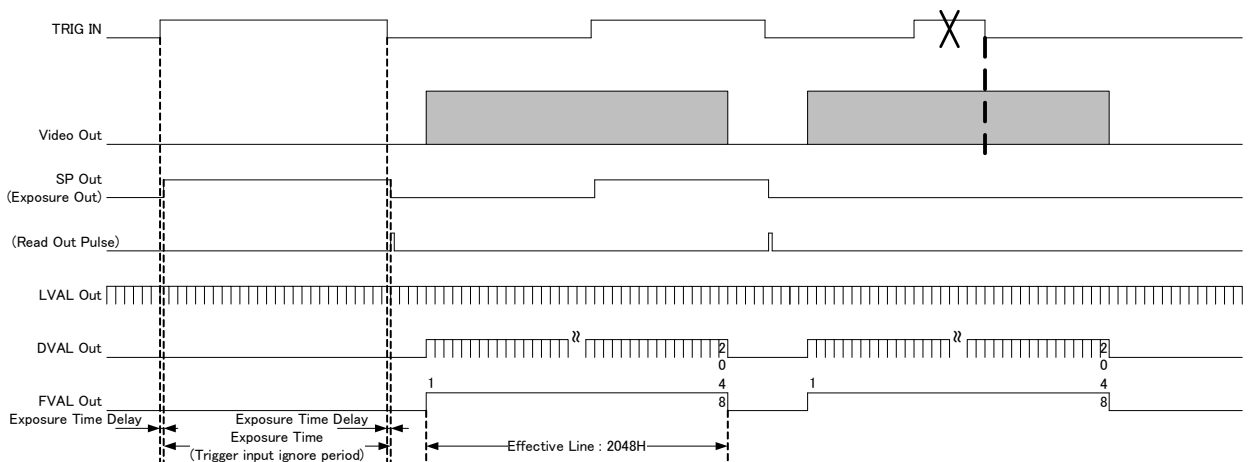

- The delay time is fixed with the Trigger Hsync Mode ON.
However, if you use inputting the trigger signals for exposure to start the next video output prior , the line noise appears occasionally by the trigger timing.

6. Partial Scan Mode

Maximum 32 partial areas can be set by serial commands.

Example : 3 partial areas to be set.

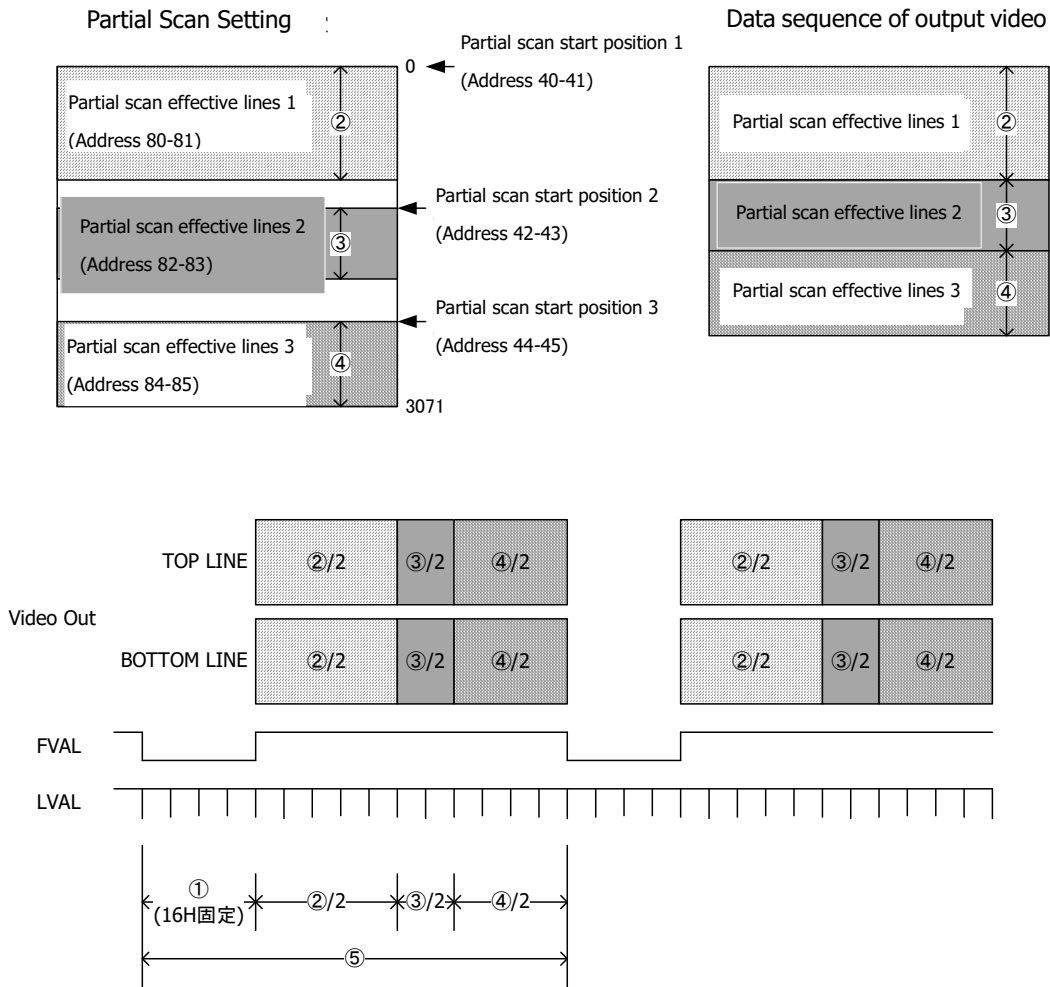

- ① : 16H fixed
- ② : Partial Area 1 : 20H
- ③ : Partial Area 2 : 6H
- ④ : Partial Area 3 : 10H
- ⑤ : Total Line numbers : $34H = 16H + ((20H + 6H + 10H) / 2)$

- When setting several partial scan areas, please set the start position and effective lines trying not to overlap the areas.
 - When setting several areas, please set the areas in the numerical order of start position.
 - Entire frame line numbers = **V blanking line numbers (16H fixed)** +
 Partial effective lines 1 + Partial effective lines 2 + ... + Partial effective lines 32/2
- Note that "Sum total of partial effective line numbers (except V blanking lines) < **3072**" should be met.
- Frame rate = 1 / (Entire frame line numbers × Time for 1 line)

Camera Mode	Time for 1 Line
2Tap Base Configuration	60.706us
4Tap Medium Configuration	30.353us
8Tap Full Configuration	15.176us

Example

	Effective Line Number	Frame Total Line Number	Frame Rate (Total Line)		
			2Tap Base Configuration	4Tap Medium Configuration	8Tap Full Configuration
4(Min)	4 H	18H	915fps	1830fps	3661fps
.	.				
Vertical:VGA	480 H	256H	64fps	129fps	257fps
.	.				
Vertical:XGA	768 H	400H	41fps	82fps	165fps
.	.				
Vertical:SXGA	1024 H	528H	31fps	62fps	125fps
.	.				
Vertical:UXGA	1200 H	616H	27fps	53fps	107fps
.	.				
3072 (Max)	3072 H	1552H	11fps	22fps	42fps

7. Remote Communication

Via camera link cable, the camera can be controlled.

Communication Settings	
Baud Rate	: 9600bps (Initial Setting)
Data	: 8bit
Stop bit	: 1bit
Parity	: None
XON / XOFF	: No Control

- Send Command Format (Host to Camera)

If send a command, set the command and parameter between STX and ETX.

STX (02H)	command (2byte)	parameter (ASCII code) (20H-7FH)	ETX (03H)
--------------	--------------------	-------------------------------------	--------------

- Return Command Format (Camera to Host)

Normally, a camera returns a control code which is ACK or NAK.

If return value has a text message, the message is between STX and ETX.

ACK (06H)	... Succeed
--------------	-------------

NAK (15H)	... Fail
--------------	----------

STX (02H)	command (2byte)	parameter (ASCII code) (2FH- 7FH)	ETX (03H)	... return message
--------------	--------------------	--------------------------------------	--------------	--------------------

- Command List

Command	Function
SR	Set some values of resister
GR	Get some values of resister
SU	Set a user's data
GU	Get a user's data
CS	Save all configurations
CR	Restore all configurations
QM	Get a model name
QS	Get a serial number
QV	Get a firmware version
QE	Get a detail of error information

7.1. Command Specifications

- 1) Set some values of resister

【Command】 Set : Resister

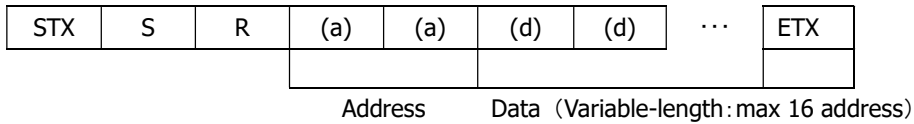

【Return Value】

Succeed	...	ACK
Fail	...	NAK

- 2) Get some value of resister

【Command】 Get : Resister

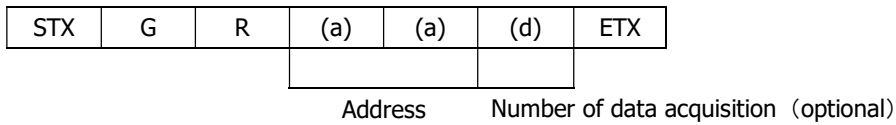

【Return value】

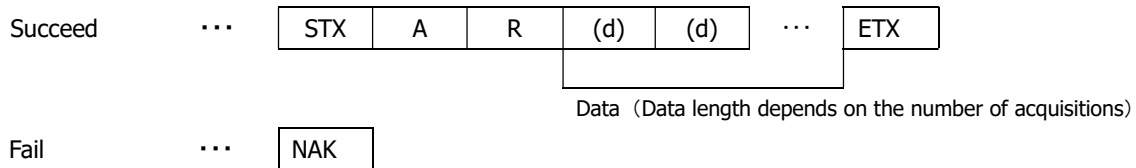

【Remarks】

The command gets some value of register of the specified address. The number of the acquisition is between '0' and 'F' (Hexadecimal).
 If appoint '0' at the address, the command send data of 16 address. If the command is omitted at the address, the command send an address.

3) Set User's data

【Command】 Set : User's data

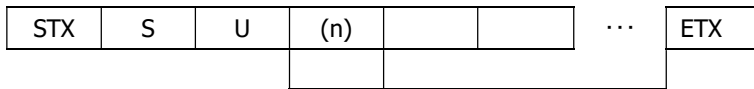

Table No. (0~3)

【Return Value】

Succeed	...	ACK
Fail	...	NAK

【Remarks】

The commands, sets free data on the specified register, and can use 4 tables (1 table : 16 characters).

4) Get User's data

【Command】 Get : User's data

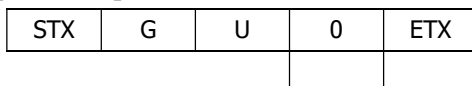
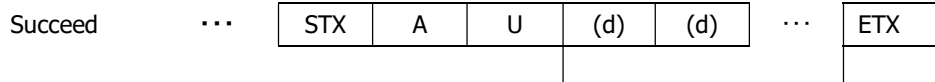

Table No. (0~3)

【Response】



User's data (fixed length : 16byte)

Fail	...	NAK
------	-----	-----

5) Save all configurations

【Command】 Configuration : Save

STX	C	S	ETX
-----	---	---	-----

【Return Value】

Succeed	...	ACK
Fail	...	NAK

6) Restore all configurations

【Command】 Configuration : Restore

STX	C	R	ETX
-----	---	---	-----

【Return Value】

Succeed	...	ACK
Fail	...	NAK

7) Get a model name

【Command】 Query : Model name

STX	Q	M	ETX
-----	---	---	-----

【Return Value】

Succeed	...	STX	R	M	(d)	(d)	...	ETX
					Model name (Fixed length: 16byte)			
Fail	...	NAK						

8) Get a serial number

【Command】 Query : Serial number

STX	Q	S	ETX
-----	---	---	-----

【Return Value】

Succeed	...	STX	R	S	(d)	(d)	...	ETX
					Serial Number(Fixed length: 8byte)			
Fail	...	NAK						

9) Get a firmware version

【Command】 Query : Version

STX	Q	V	ETX
-----	---	---	-----

【Return Value】

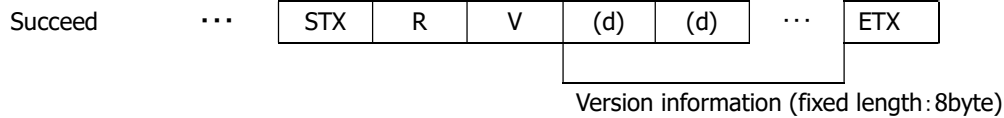

10) Get a detail of error information

【Command】 Query : Error

STX	Q	E	ETX
-----	---	---	-----

【Return Value】

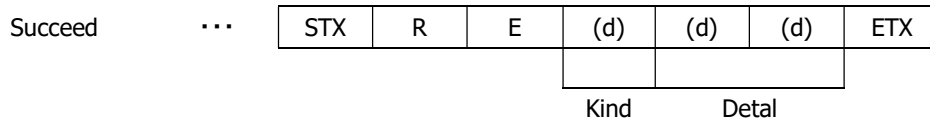

Kind	Detail
0: No Error	00: Normal result
1: Communication Protocol Error	00: The command is undefined.
	01: The command length is more than defined.
	02: The address is undefined.
	03: The value of data is undefined.
	04: The length is more than defined.
	05: The table number is undefined.
	06: The string of user data was abnormal.
2: Internal Control Error	00: Internal control is abnormal.
	01: A read only address was written by the command.
	02: A protected address was written by the command.
	03: Out of range address was written by the command.
	04: The selected table number is abnormal.
	05: The value of the man acquisition area is abnormal.
	06: A function is not implemented.

7.2. Control Example

1) How to check trigger shutter mode. (The command gets a value from address 04)

【Send Command】

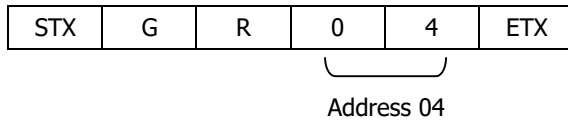

【Return value form camera】

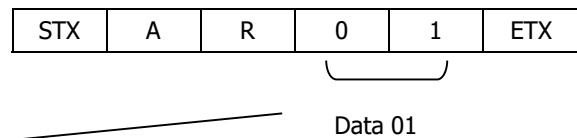

【Receive Return Value】

The camera is working with a trigger shutter mode, because the command received a 01 from the camera.

2) How to check trigger shutter mode. (The command gets consecutive 2 bytes values from address 20)

【Send Command】

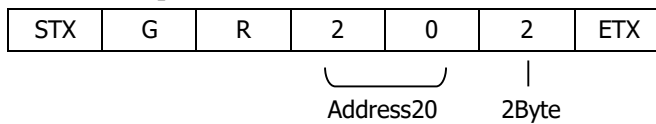

【Receive return value】

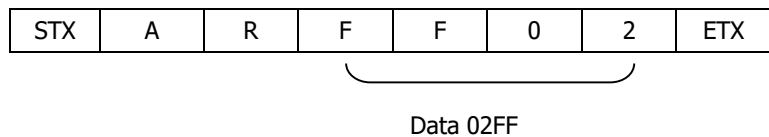

【Receive return value】

The shutter mode of camera is working +12dB, because the command received a 02FF(767) from the camera.

3) How to set partial scan mode. (The command sets 01 for address 08)

【Send Command】

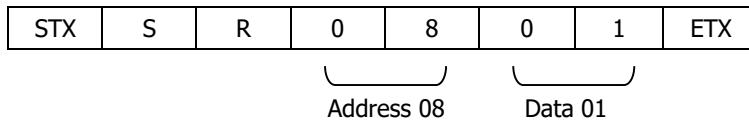

【Return value form camera】

ACK

【Receive Return Value】

The command finished normally, because the command received ACK from the camera.

4) How to set 01FF for manual shutter. (The command set 01FF for address 24)

【Send Command】

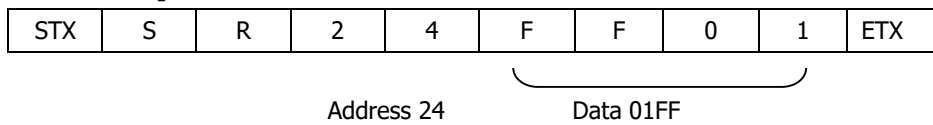

【Return value form camera】

ACK

【Receive Return Value】

The command finished normally, because the command received ACK from the camera.

5) How to save configurations of a camera. (The command send CS)

【Send Command】

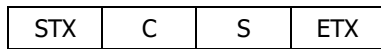

【Return value form camera】

ACK

【Receive Return Value】

The command finished normally, because the command received ACK from the camera.

6) How to restore the camera to initial settings. (The command send CR)

【Send Command】

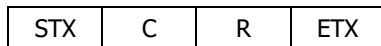

【Return value form camera】

ACK

【Receive Return Value】

The command finished normally, because the command received ACK from the camera.

7) How to get detail of a communication error.

【Send Command】

STX	G	R	@	0	ETX
-----	---	---	---	---	-----

Set the address invalid value



【Return value form camera】

NAK



【Receive return value】

The command finished abnormally, because the command received 'NAK' from the camera.

When the command did not finish normally, retry to send command or send to get detail of a detail error command.

【Send Command】

STX	Q	E	ETX
-----	---	---	-----

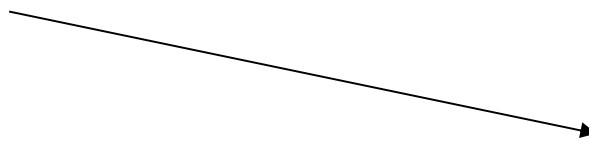

【Return value form camera】

STX	R	E	1	0	2	ETX
-----	---	---	---	---	---	-----

Kind1 Detail 02



【Receive Return Value】

The 'GR' command accessed invalid address , because the error command received kind '1' and detail '02'.

8. Function Setting

Function	Address(Hex)	Data(Hex)			
Shutter	01		2Tap Base Configuration	4Tap Medium Configuration	8Tap Full Configuration
		00:	1/11s(OFF)	1/22s(OFF)	1/42s(OFF)
		01:	1/22s	1/22s(OFF)	1/42s(OFF)
		02:	1/42s	1/42s	1/42s(OFF)
		03:	1/100s	1/100s	1/100s
		04:	1/200s	1/200s	1/200s
		05:	1/400s	1/400s	1/400s
		06:	1/800s	1/800s	1/800s
		07:	1/1000s	1/1000s	1/1000s
		08:	1/2000s	1/2000s	1/2000s
		09:	1/4000s	1/4000s	1/4000s
		0A:	1/6000s	1/6000s	1/6000s
		0B:	1/8000s	1/8000s	1/8000s
		0C:	1/9500s	1/9500s	1/9500s
		0D:	1/9500s	1/13000s	1/13000s
		0E:	1/9500s	1/13000s	1/17000s
0F:	Manual (Refer to Address 24-25)				
White Balance (Color model)	02	00:	THRU		
		01:	3200K		
		02:	THRU(Spare)		
		03:	Manual		
Trigger Mode	04	00:	Normal (Trigger OFF)		
		01:	Fixed Trigger Shutter Mode		
		02:	Pulse Width Trigger Shutter Mode		
Trigger Polarity	05	00:	Positive		
		01:	Negative		
Trigger Input	06	00:	CC1		
		01:	12pin Connector 11pin Input		
Partial Scan Mode	08	00:	Full Frame		
		01:	Partial Scan		
Output Mode	0A	00:	8Tap Full Configuration (42fps)		
		01:	8Tap Full Configuration (42fps)		
		02:	4Tap Medium Configuration (22fps)		
		03:	2Tap Base Configuration (11fps)		
Output Data Selection	0B	00:	8bit		
		01:	10bit		

Function	Address(Hex)	Data(Hex)	
Baud Rate	10	00:	9600bps
		01:	19200bps
		02:	38400bps
		03:	57600bps
		04:	115200bps
Trigger HSync Mode	17	00:	OFF
		01:	ON
Output Image Flip Vertical	18	00:	Normal
		01:	Flip Vertical
LED ON/OFF	1B	00:	OFF
		01:	ON
Manual Gain	20-21	LLHH:	min:0(0H) - max:767(2FFH) 0: x1(0dB), 767: x4(+12dB)
Manual Shutter	24-25	LLHH:	min:0(0H) - max:1535(5FFH)
			2Tap Base Configuration: Shutter time = 45.205us + (1536 - (setting value))×60.706us min:0=93.287ms(1/11s), max:1535=105.911us(1/9500s)
			4Tap Medium Configuration : Shutter time = 45.205us + (1536 - (setting value))×30.353us min:0=46.667ms(1/21s), max:1535=75.558us(1/13000s)
			8Tap Full Configuration : Shutter time = 45.205us + (1536 - (setting value))×15.176us min:0=23.355ms(1/42s), max:1535=60.381us (1/17000s)
Manual White Balance R (Color model)	28-29	LLHH:	min:0(0H) - max:767(2FFH) 0: x1(0dB), 767: x4(+12dB)
Manual White Balance B (Color model)	2A-2B	LLHH:	min:0(0H) - max:767(2FFH) 0: x1(0dB), 767: x4(+12dB)
Manual White Balance G (Color model)	2C-2D	LLHH:	min:0(0H) - max:767(2FFH) 0: x1(0dB), 767: x4(+12dB)

※ LLHH : The data set with 2 Byte shall be set with Low Byte first, then set with High Byte.

< Example > Manual Shutter (Address 24-25) ->6671(1A0FH)

STX SR 24 0F 1A ETX

Function	Address(Hex)	Data(Hex)	
Partial Scan	40-41	LLHH:	min:0(0H) - max:3068(BFCH) *Start Position -> Multiples of 4 number
Start Position 1			
Start Position 2	42-43		
Start Position 3	44-45		
Start Position 2	42-43		
Start Position 3	44-45		
Start Position 4	46-47		
Start Position 5	48-49		
Start Position 6	4A-4B		
Start Position 7	4C-4D		
Start Position 8	4E-4F		
Start Position 9	50-51		
Start Position 10	52-53		
Start Position 11	54-55		
Start Position 12	56-57		
Start Position 13	58-59		
Start Position 14	5A-5B		
Start Position 15	5C-5D		
Start Position 16	5E-5F		
Start Position 17	60-61		
Start Position 18	62-63		
Start Position 19	64-65		
Start Position 20	66-67		
Start Position 21	68-69		
Start Position 22	6A-6B		
Start Position 23	6C-6D		
Start Position 24	6E-6F		
Start Position 25	70-71		
Start Position 26	72-73		
Start Position 27	74-75		
Start Position 28	76-77		
Start Position 29	78-79		
Start Position 30	7A-7B		
Start Position 31	7C-7D		
Start Position 32	7E-7F		

※ LLHH : The data set with 2 Byte shall be set with Low Byte first, then set with High Byte.

< Example > Manual Shutter(Address 24-25) ->6671(1A0FH)

STX SR 24 0F 1A ETX

Function	Address(Hex)	Data(Hex)	
Partial Scan	80-81	LLHH:	min:4(4H) - max:3072(C00H) *Effective line number -> Multiples of 4 number
Effective Line Number 1			
Effective Line Number 2	82-83		
Effective Line Number 3	84-85		
Effective Line Number 4	86-87		
Effective Line Number 5	88-89		
Effective Line Number 6	8A-8B		
Effective Line Number 7	8C-8D		
Effective Line Number 8	8E-8F		
Effective Line Number 9	90-91		
Effective Line Number 10	92-93		
Effective Line Number 11	94-95		
Effective Line Number 12	96-97		
Effective Line Number 13	98-99		
Effective Line Number 14	9A-9B		
Effective Line Number 15	9C-9D		
Effective Line Number 16	9E-9F		
Effective Line Number 17	A0-A1		
Effective Line Number 18	A2-A3		
Effective Line Number 19	A4-A5		
Effective Line Number 20	A6-A7		
Effective Line Number 21	A8-A9		
Effective Line Number 22	AA-AB		
Effective Line Number 23	AC-AD		
Effective Line Number 24	AE-AF		
Effective Line Number 25	B0-B1		
Effective Line Number 26	B2-B3		
Effective Line Number 27	B4-B5		
Effective Line Number 28	B6-B7		
Effective Line Number 29	B8-B9		
Effective Line Number 30	BA-BB		
Effective Line Number 31	BC-BD		
Effective Line Number 32	BE-BF		

※ LLHH : The data set with 2 Byte shall be set with Low Byte first, then set with High Byte.

< Example > Manual Shutter(Address 24-25) ->6671(1A0FH)

STX SR 24 0F 1A ETX

9. CMOS Optical Axis Accuracy

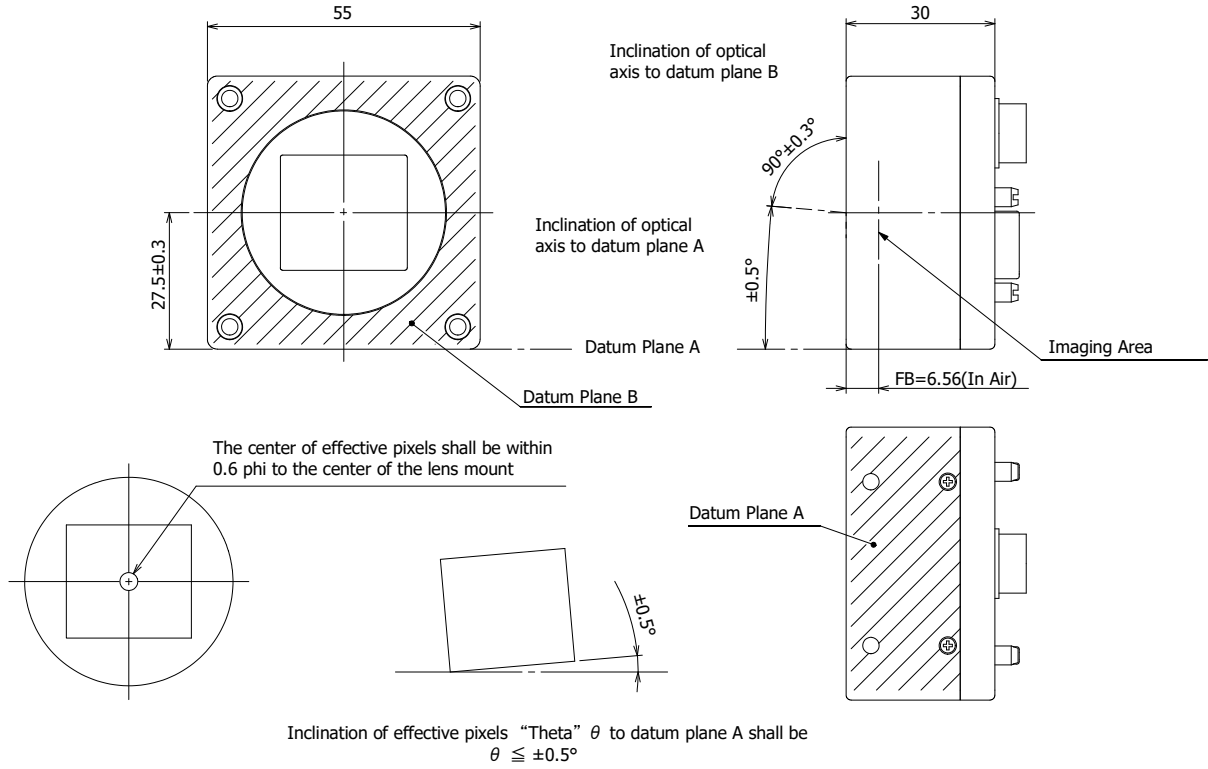

10. Dimensions

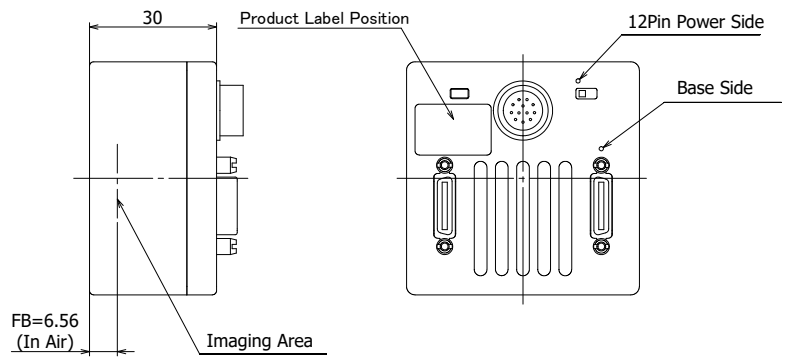
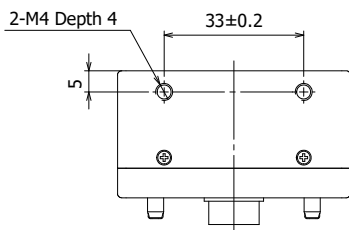
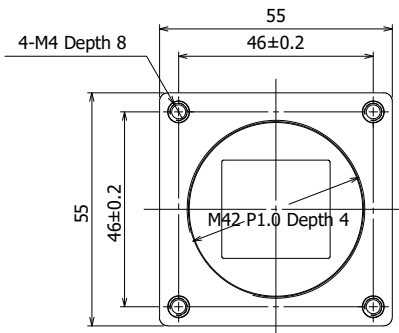
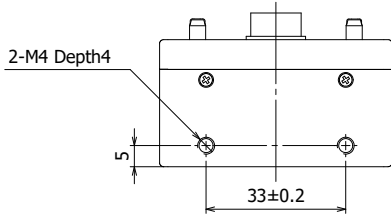

11. ID-M42F (M42 P1-F Mount Adaptor) *Option

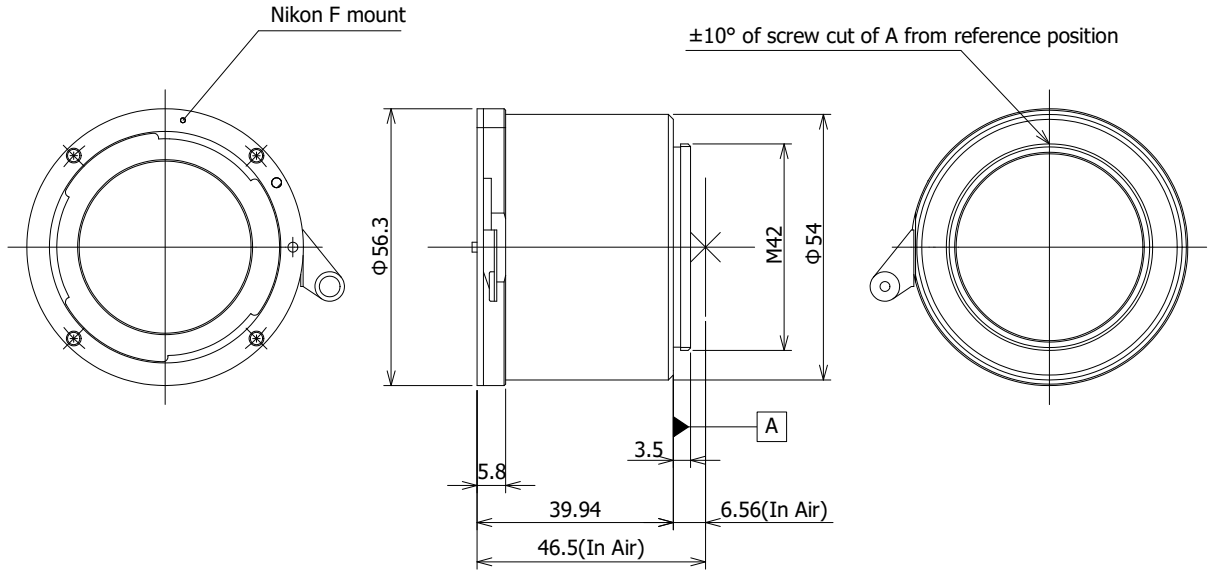

12. Initial Setting

Function	Address	Data	
Shutter	01	00:	1/42s(OFF)
White Balance (Color model)	02	01:	3200K
Trigger Mode	04	00:	Normal (Trigger OFF)
Trigger Polarity	05	00:	Positive
Trigger Input	06	00:	CC1
Partial Scan Mode	08	00:	Full Frame
Camera Mode	0A	00:	8Tap Full Configuration
Output Data Selection	0B	00:	8bit
Baud Rate	10	00:	9600bps
Trigger Hsync Mode	17	00:	OFF
Output Image Flip Vertical	18	00:	Normal
LED ON/OFF	1B	01:	ON
Manual Gain	20-21	0000:	0dB
Manual Shutter	24-23	0000:	Shutter (OFF)
Manual White Balance R (Color model)	28-29	0000:	0dB
Manual White Balance B (Color model)	2A-2B	0000:	0dB
Manual White Balance G (Color model)	2C-2D	0000:	0dB
Partial Scan Start Position	40-7F	0000:	Start Position 0
Partial Scan Effective Lines	80-BF	0000:	Effective Lines 0

Camera Rear Panel Switch Setting	
Power Input Selecting Switch	from 12pin connector

13. Cases for Indemnity (Limited Warranty)

We shall be exempted from taking responsibility and held harmless for damage or losses incurred by the user in the following cases.

- In case damage or losses are caused by fire, earthquake, or other acts of God, acts by third party, deliberate or accidental misuse by the user, or use under extreme operating conditions.
- In case indirect, additional, consequential damages (loss of business interests, suspension of business activities) are incurred as result of malfunction or non-function of the equipment, we shall be exempted from responsibility for such damages.
- In case damage or losses are caused by failure to observe the information contained in the instructions in this product specification & operation manual.
- In case damage or losses are caused by use contrary to the instructions in this product specification & operation manual.
- In case damage or losses are caused by malfunction or other problems resulting from use of equipment or software that is not specified.
- In case damage or losses are caused by repair or modification conducted by the customer or any unauthorized third party (such as an unauthorized service representative).

14. CMOS Pixel Defect

IDULE compensates the noticeable CMOS pixel defects found at the shipping inspection prior to our shipment. On very rare occasions, however, CMOS pixel defects might be noted with time of usage of the products.

Cause of the CMOS pixel defects is the characteristic phenomenon of CMOS itself and IDULE is exempted from taking any responsibilities for them. Should you have any questions on CMOS pixel defects compensation, please contact us.

15. Product Support

When defects or malfunction of our products occur, and if you would like us to investigate on the cause and repair, please contact your distributors you purchased from to consult and coordinate.
