1.2Mega CMOS Camera

ID1MB-CL (B/W)

ID1MC-CL (COLOR)

Technical Manual

iDule Corporation

Table of Contents

PAGE

1.	Product Outline	3
2.	Handling Precautions	3
3.	Specification	4
	3.1.General Specification	4
	3.2.Camera Output Signal Specification	5
	3.3.Spectral Response (Representative Value)	6
4.	Connector	7
	4.1.Camera Link 12226-1100-00PL(3M)	7
	4.2.Power LED	7
	4.3.12pin Connector HR10A-10R-12PB(74) HIROSE	8
5.	Timing Chart	9
	5.1.Horizontal Synchronous Signals Timing (1Tap Base Configuration)	9
	5.2.Vertical Synchronous Signals Timing (1Tap Base Configuration)	9
	5.3.Horizontal Synchronous Signals Timing (1Tap Base Configuration / Fixed trigger shutter mode).....	10
	5.4.Vertical Synchronous Signals Timing (1Tap Base Configuration / Fixed trigger shutter mode).....	10
	5.5.Horizontal Synchronous Signals Timing (2Tap Base Configuration)	11
	5.6.Vertical Synchronous Signals Timing (2Tap Base Configuration)	11
	5.7. Horizontal Synchronous Signals Timing (2Tap Base Configuration / Fixed trigger shutter mode)	12
	5.8.Vertical Synchronous Signals Timing (2Tap Base Configuration / Fixed trigger shutter mode).....	12
	5.9.Horizontal Synchronous Signals Timing (Base Configuration 24bit – RGB)	13
	5.10.Vertical Synchronous Signals Timing (Base Configuration 24bit – RGB)	13
	5.11.Horizontal Synchronous Signals Timing (Base Configuration 24bit – RGB / Fixed trigger shutter mode).....	14
	5.12.Vertical Synchronous Signals Timing (Base Configuration 24bit – RGB / Fixed trigger shutter mode).....	14
	5.13.Output format.....	15
	5.14.Fixed Trigger Shutter Mode	16
6.	Scan Mode	17
	6.1.Partial scan mode	17
	6.2.Binning mode	19
	6.3.VGA mode.....	20
	6.4.QVGA mode.....	21
7.	Remote Communication	22
	7.1.Command Specifications	23
	7.2.Control Example.....	27
8.	Dimensions	36
9.	Initial Setting	37
10.	Cases for Indemnity (Limited Warranty)	38
11.	CMOS Pixel Defect	38
12.	Product Support	38

1. Product Outline

ID1MB-CL/ID1MC-CL is a Camera Link interfaced and 1.2Mega resolution camera module. 1.2Mega pixels CMOS sensor with diagonal length 6mm is utilized. Entire pixels can be read out within 1/54s at CL Base Configuration output.

Features

- Global Shutter CMOS sensor is utilized.
- Camera Link Base Configuration is supported.
- Fixed trigger shutter mode.
- Binning mode(2x2), VGA mode, QVGA mode.

2. Handling Precautions

The camera must not be used for any nuclear equipment or aerospace equipment with which mechanical failure or malfunction could result in serious bodily injury or loss of human life. Our warranty does not apply to damages or defects caused by irregular and /or abnormal use of the product.

Please observe all warnings and cautions stated below.

Our warranty does not apply to damages or malfunctions caused by neglecting these precautions.

Do not use or store the camera in the following extreme conditions :

- Extremely dusty or humid places.
 - Extremely hot or cold places (operating temperature -5°C to +45°C).
 - Close to generators of powerful electromagnetic radiation such as radio or TV transmitters.
 - Places subject to fluorescent light reflections.
 - Places subject to unstable (flickering, etc.) lighting conditions.
 - Places subject to strong vibration.
-
- Remove dust or dirt on the surface of the lens with a blower.
 - Do not apply excessive force or static electricity that could damage the camera.
 - Do not shoot direct images that are extremely bright (e.g., light source, sun, etc.), and when camera is not in use, put the lens cap on.
 - Confirm the mutual ground potential carefully and then connect the camera to monitors or computers. AC leaks from the connected devices may cause damages or destroy the camera.
 - Do not apply excessive voltage. (Use only the specified voltage.) Unstable or improper power supply voltage may cause damages or malfunction of the camera.
 - The voltage ripple of camera power DC +12V±10% shall be within ±50mV. Improper power supply voltage may cause noises on the video signals.
 - The rising time of camera power supply voltage shall be less than +10V, Max 60ms. Please avoid noises like chattering when rising.

3. Specification

3.1.General Specification

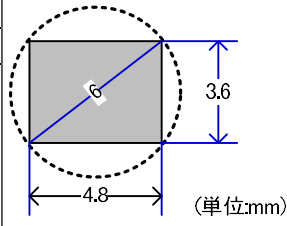
(1) Image Sensor	Type	Diagonal length 6mm Global Shutter (ON SEMICONDUCTOR AR0135)	
	Effective Pixel Number	1288(H) x 972(V)	
	Cell Size	3.75 μ m(H) x 3.75 μ m(V)	
	Image Circle	Full : Φ 6mm VGA mode : Φ 3mm QVGA mode : Φ 1.5mm	
		 <p>(單位:mm)</p>	
(2) Video Output Frequency	Pixel CLK	74.25MHz (1Tap / 24bit-RGB) / 37.125MHz (2Tap)	
	Output effective pixel number	Full : 1284(H) x 962(V) VGA mode : 640(H) x 480(V) QVGA mode : 320(H) x 240(V)	
	Frame rate	Full : 54.08fps VGA mode : 105.51fps QVGA mode : 200.35fps	1388(H) x 989(V) : with Blanking 1388(H) x 507(V) : with Blanking 1388(H) x 267(V) : with Blanking
(3) Video Output	1Tap Base Configuration, 2Tap Base Configuration, Base Configuration 24bit – RGB		
(4) Output Format	Sensor AD	12bit	
	Camera Link	8bit / 10bit / 12bit	
(5) Sensitivity	B/W	F8	2000lx
	Color	F5.6	2000lx
(at shutter speed 1/54s(OFF), Gain 0dB)			
(6) Minimum Illumination	B/W	F1.4	4lx
	Color	F1.4	8lx
(at shutter speed 1/54s(OFF), Gain +12dB)			
(7) Power Requirements	DC+12V \pm 10% (12pin / PoCL)		
(8) Power Consumption	typ 0.9 W max 1.1 W		
(9) Dimensions	H:29.0mm W:29.0mm D:29.0mm excluding projection		
(10) Weights	Approx. 50g		
(11) Lens Mount	C Mount		
(12) Gain	0dB ~ +12dB		
(13) Shutter Speed	OFF(1/54s) ~ 1/54000s(Normal mode)		
	OFF(1/45s) ~ 1/45000s (Trigger mode)		
(14) Trigger mode	Fixed trigger shutter mode		
(15) Scan Mode	Partial scan : Full Frame ~ 4 Line (4Line/Step) Partial Area : 1area		
	Binning mode : 640 x 480 line		
	VGA mode : 640 x 480 line		
	QVGA mode : 320 x 240 line		
(16) Safety/ Quality Standards	CE	To be applied for EN61000-6-4:2007+A1:2011 for Emission To be applied for EN61000-6-2:2005 for Immunity	
	RoHS: Conform to RoHS		
(17) Durability	Vibration	20~200 Hz, 98m/s ² (10G), X,Y and Z directions (120 min for each direction)	
	Shock	No malfunction shall be occurred with 980m/s ² (100G) for \pm X, \pm Y, \pm Z, 6 directions. (without package)	
(18) Environment	Operation	0 $^{\circ}$ C ~ +45 $^{\circ}$ C Humidity 0 ~ 90%RH	
	Storage	-25 $^{\circ}$ C ~ +65 $^{\circ}$ C Humidity 0 ~ 90%RH	

3.2.Camera Output Signal Specification

(1)Video Output Data	Effective Video Output	1284(H) × 962(V)	(at Full Frame Scan Mode)
(2)Sync Signal Output	LVAL FVAL DVA SP(Exposure Signal)	Camera Link (LVDS)	
(3)Camera Control Signal Input	CC2·CC3·CC4	Camera Link Input(LVDS)	
(4)Trigger Input	Polarity	Positive/Negative Selectable	(Address 05)
	CC1	Camera Link Input (LVDS)	(Address 06)
(5)Serial Communication	SerTC	Camera Link (LVDS)	(Serial to Camera)
	SerTFG	Camera Link (LVDS)	(Serial to Frame Grabber)
(6)Video Signals	White Clip Level	FFEh	(at Gain 0dB, 12bit)
	Setup Level	under 0C0h	
	Dark Shading	Both horizontal and vertical should be under 0FFh	
(7)Trigger in CN1	CN1 : 11 pin	Low1.4V(max),High3.3V~5.0V	(Address 06)
(8)Exposure out CN1	CN1 : 6 pin	Low0.55V(max),High3.8V(min)	
(9)FVAL out CN1	CN1 : 7 pin	Low0.55V(max),High3.8V(min)	

Trigger in CN1

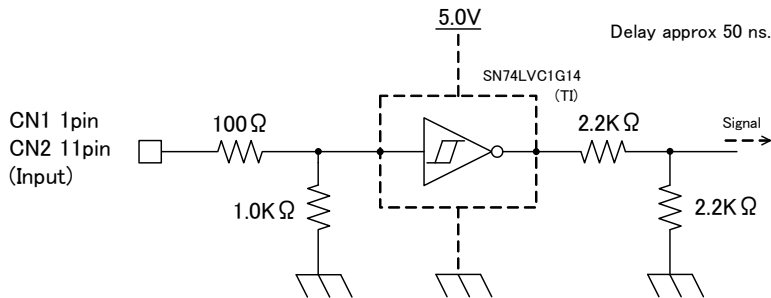

Exposure / FVAL out CN1

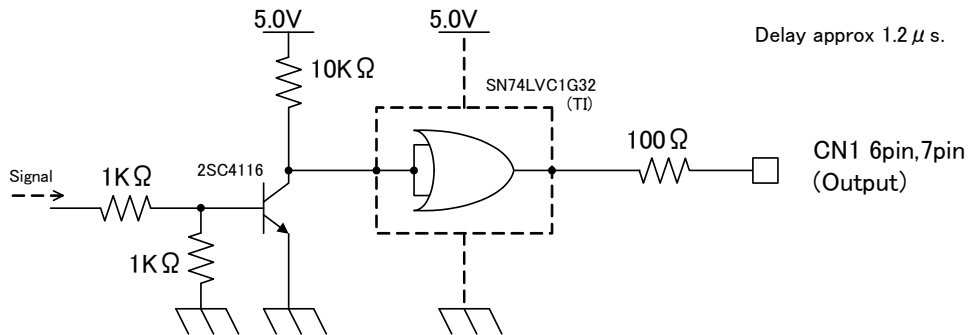

3.3.Spectral Response (Representative Value)

ID1MB-CL (B/W)

NOT FOR PUBLIC RELEASE

AR0135CS

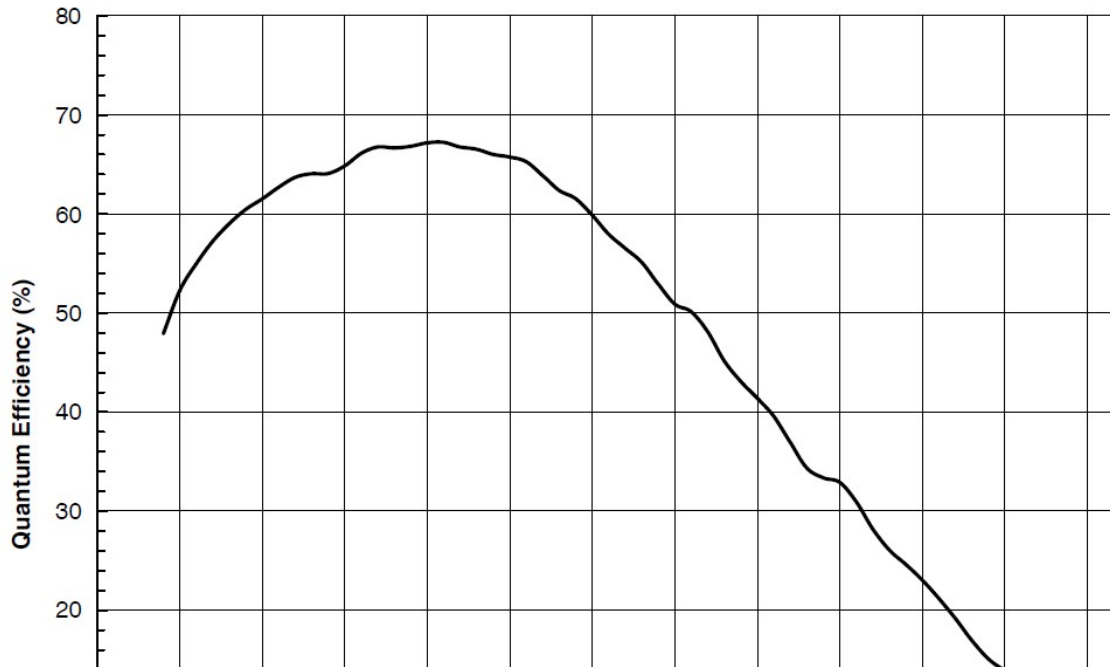

ID1MC-CL (Color)

Figure 23. Quantum Efficiency – Monochrome Sensor (Typic

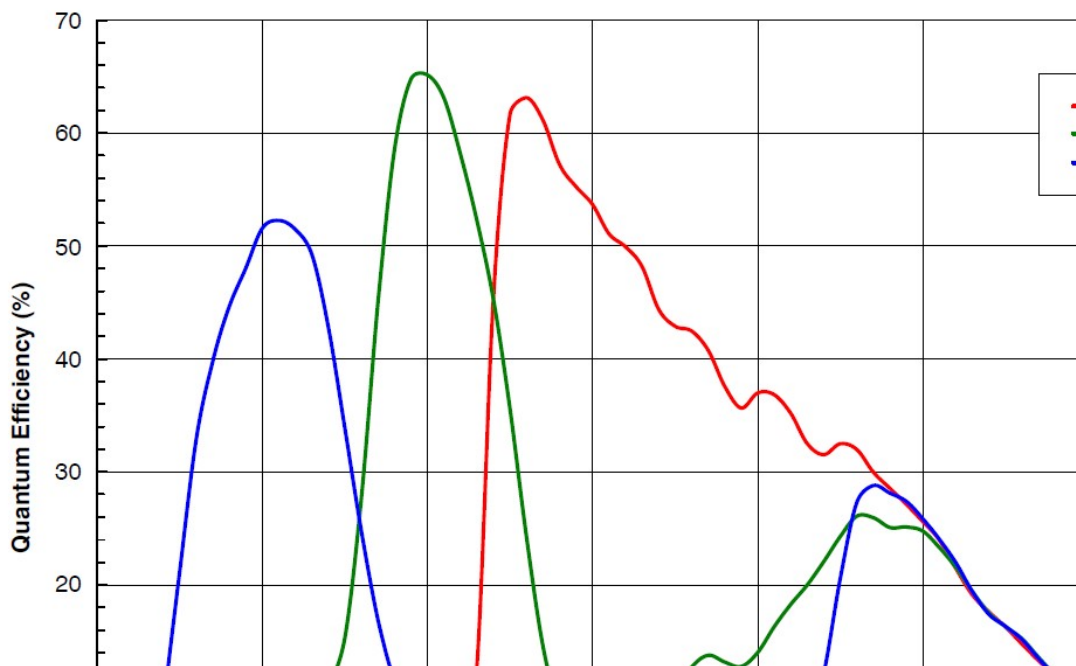

4. Connector

4.1.Camera Link 12226-1100-00PL(3M)

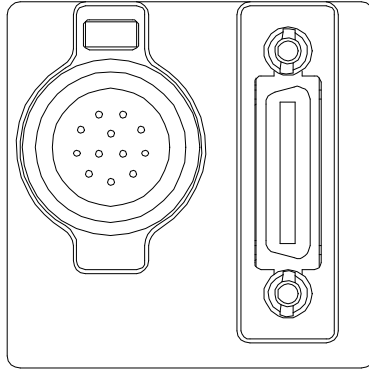

Connector (P1)

PIN NO		PIN NO	
1	+12V(PoCL)	14	GND
2	X0-	15	X0+
3	X1-	16	X1+
4	X2-	17	X2+
5	Xclk-	18	Xclk+
6	X3-	19	X3+
7	SerTC+	20	SerTC-
8	SerTFG-	21	SerTFG+
9	CC1- (Trigger IN -)	22	CC1+ (Trigger IN +)
10	CC2+	23	CC2-
11	CC3-	24	CC3+
12	CC4+	25	CC4-
13	GND	26	+12V(PoCL)

4.2.Power LED

Camera turns on LED light, when it is supplied electricity from the frame Grabber board.

4.3.12pin Connector HR10A-10R-12PB(74) HIROSE

PIN NO	
1	GND
2	Power Input (DC+12V)
3	GND
4	NC
5	GND
6	FVAL out
7	Exposure out
8	GND
9	NC
10	NC
11	Trigger in
12	GND

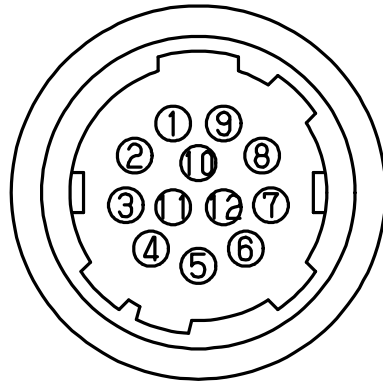

*Do not supply power from both P1 and CN1.

5. Timing Chart

5.1. Horizontal Synchronous Signals Timing (1Tap Base Configuration)

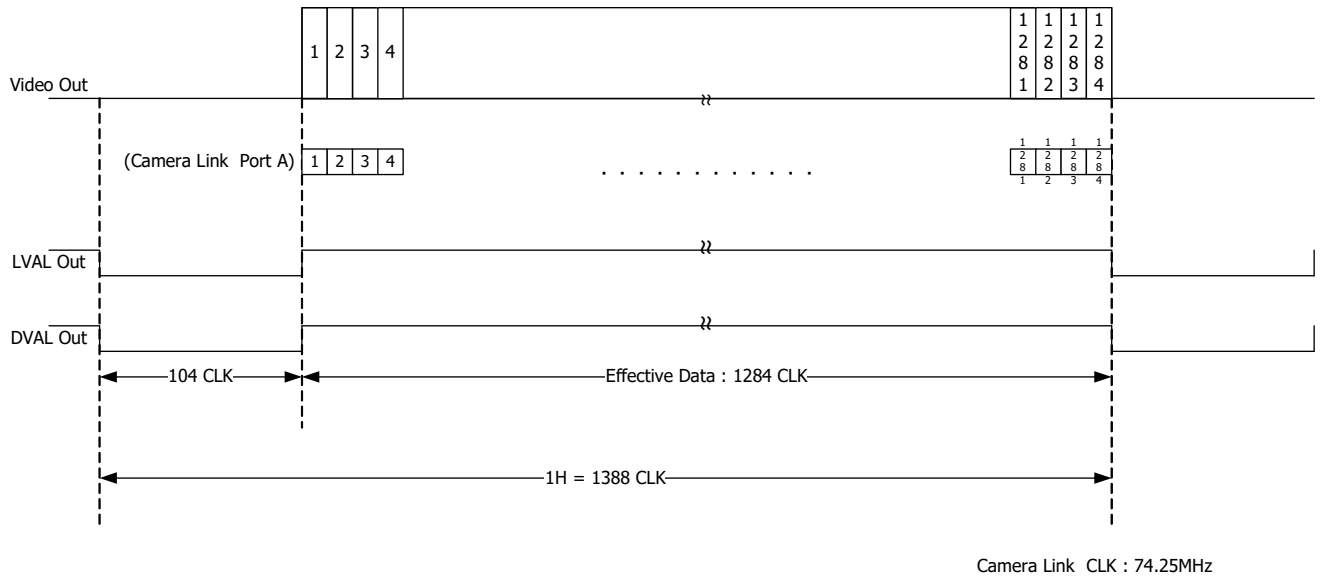

5.2. Vertical Synchronous Signals Timing (1Tap Base Configuration)

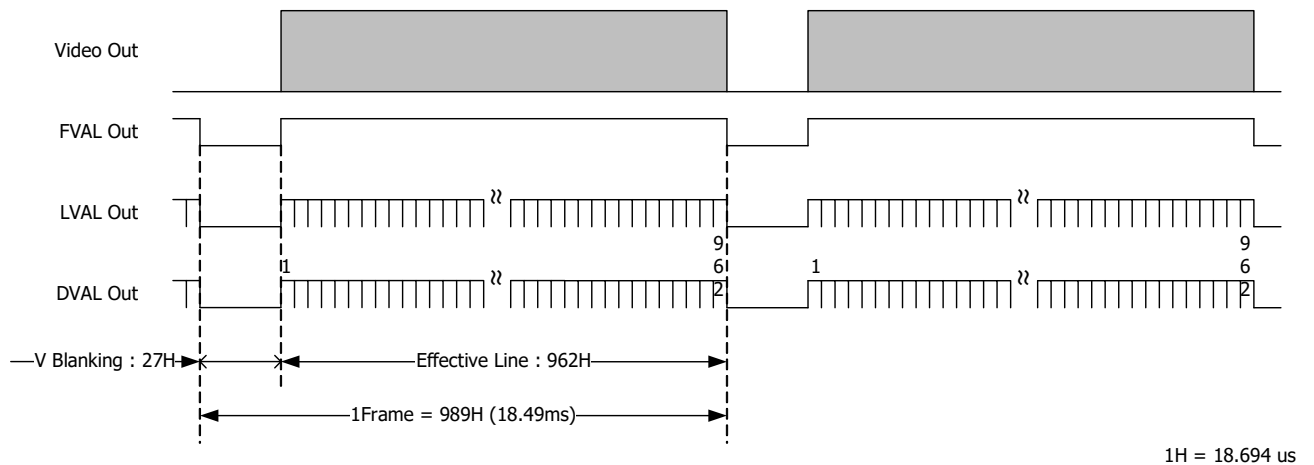

5.3. Horizontal Synchronous Signals Timing (1Tap Base Configuration / Fixed trigger shutter mode)

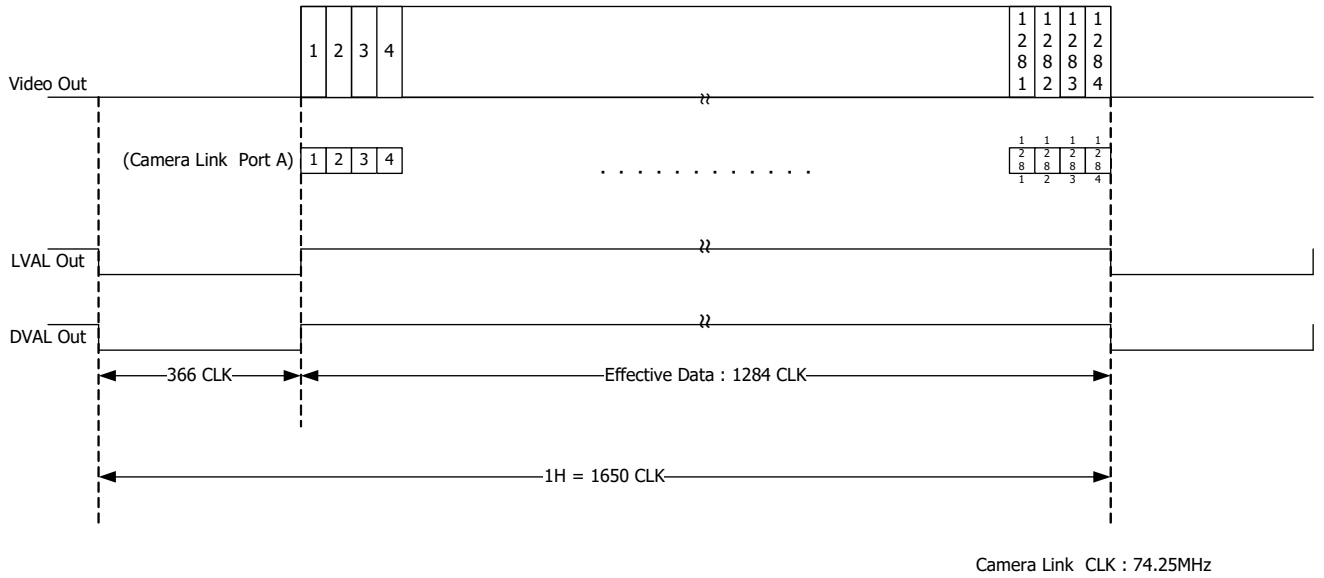

5.4. Vertical Synchronous Signals Timing (1Tap Base Configuration / Fixed trigger shutter mode)

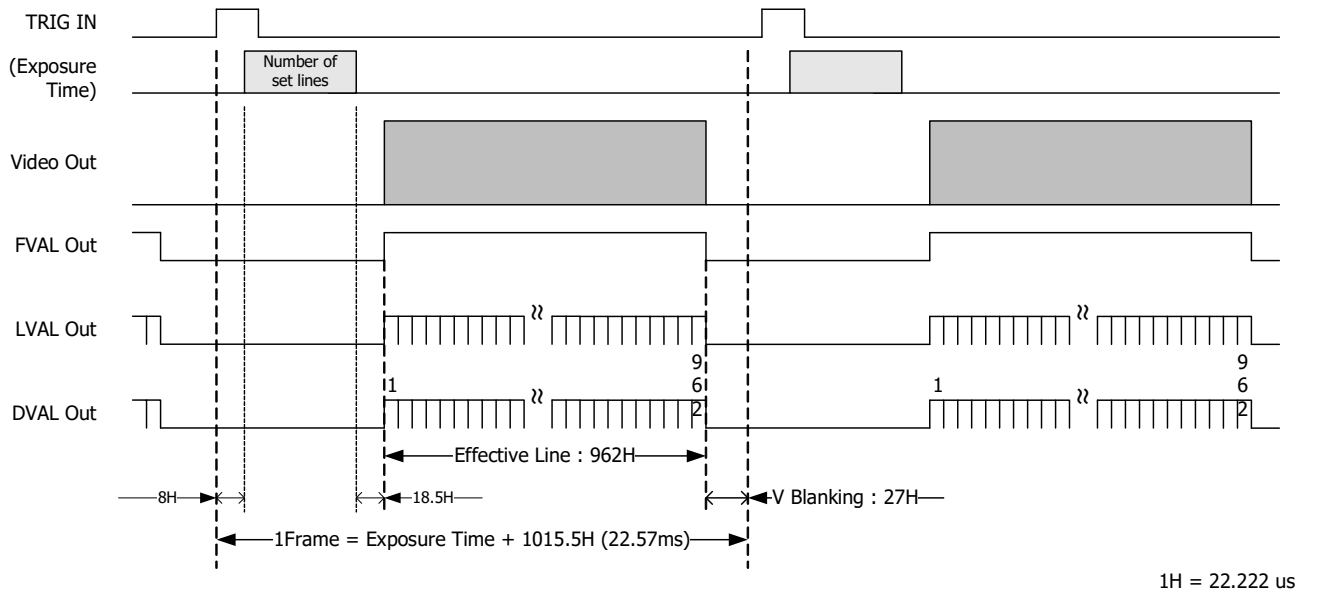

5.5. Horizontal Synchronous Signals Timing (2Tap Base Configuration)

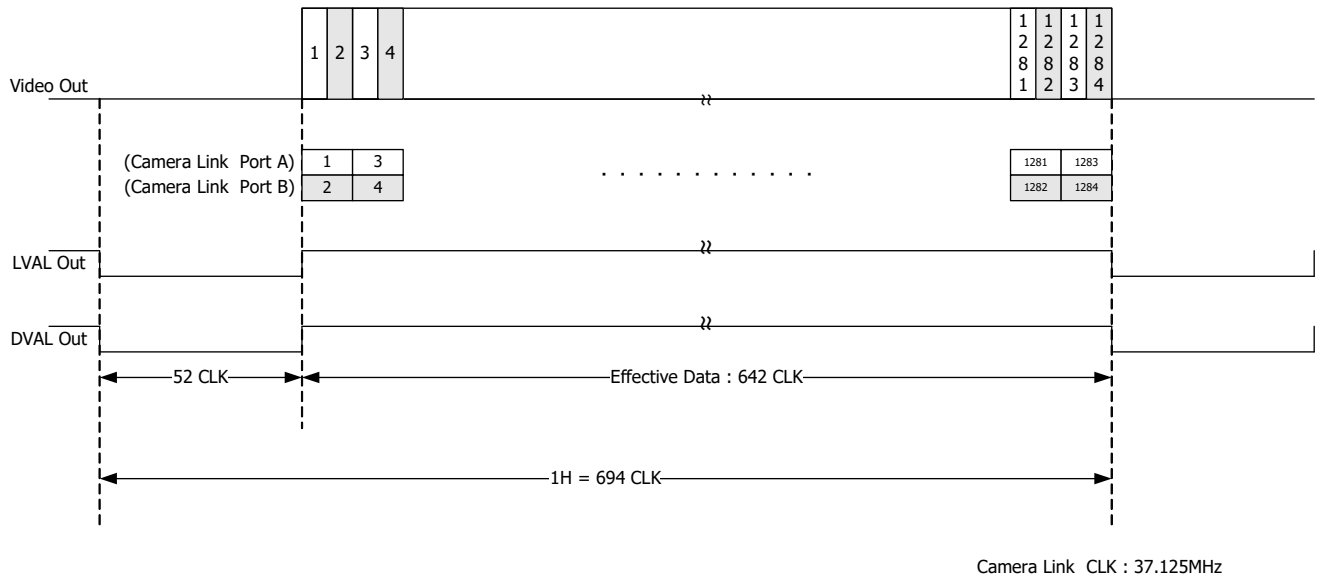

5.6. Vertical Synchronous Signals Timing (2Tap Base Configuration)

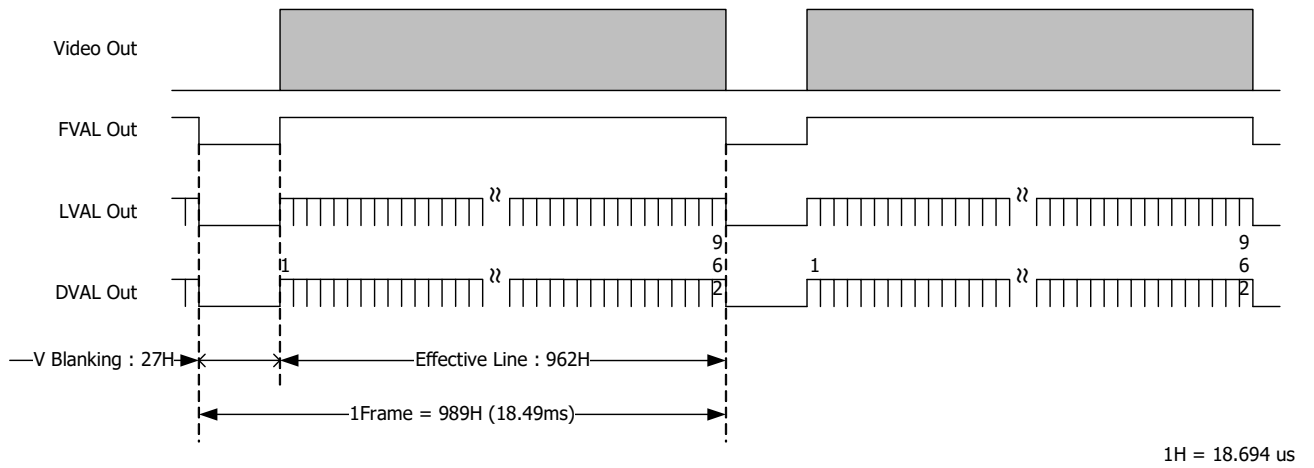

5.7. Horizontal Synchronous Signals Timing (2Tap Base Configuration / Fixed trigger shutter mode)

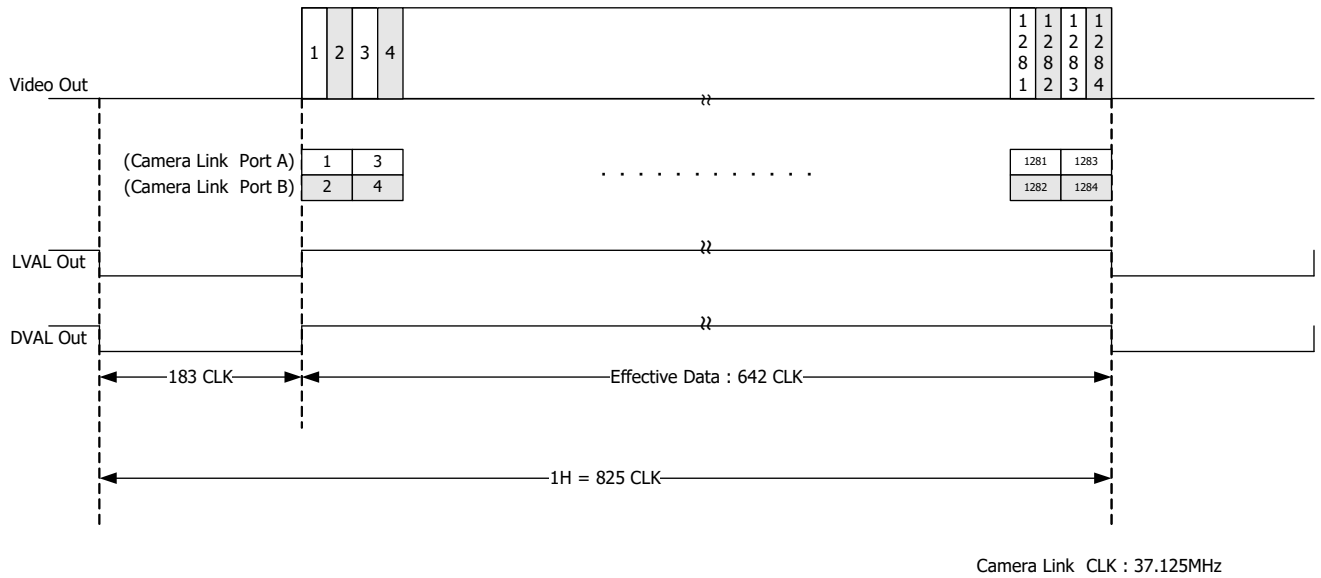

5.8. Vertical Synchronous Signals Timing (2Tap Base Configuration / Fixed trigger shutter mode)

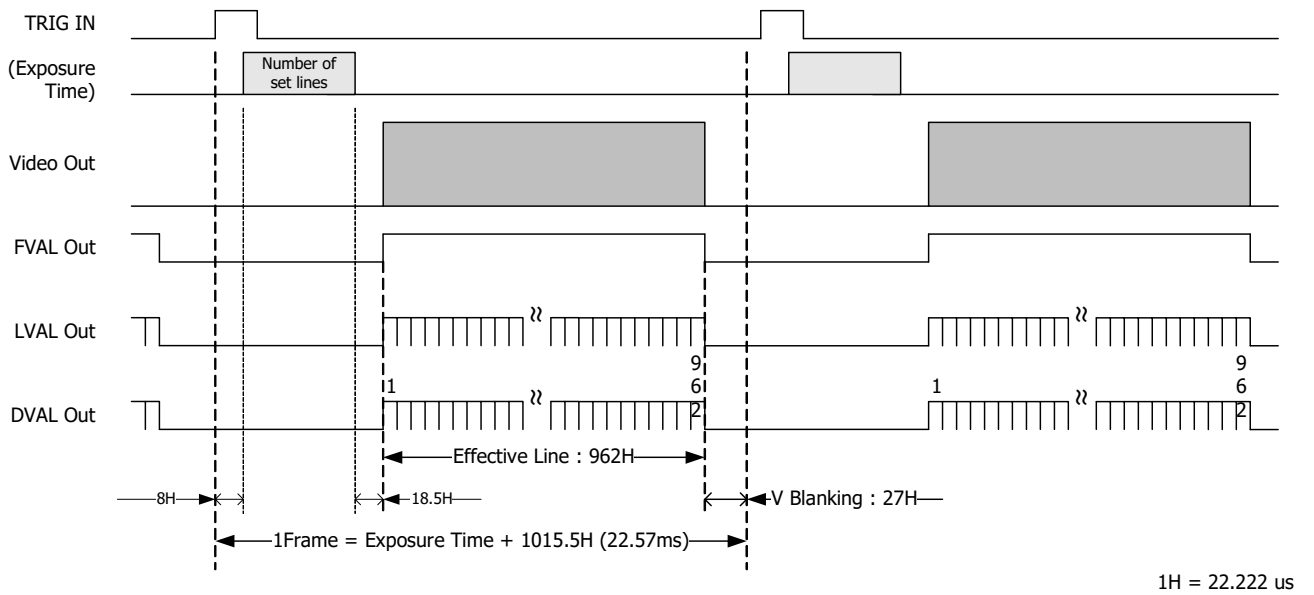

5.9. Horizontal Synchronous Signals Timing (Base Configuration 24bit – RGB)

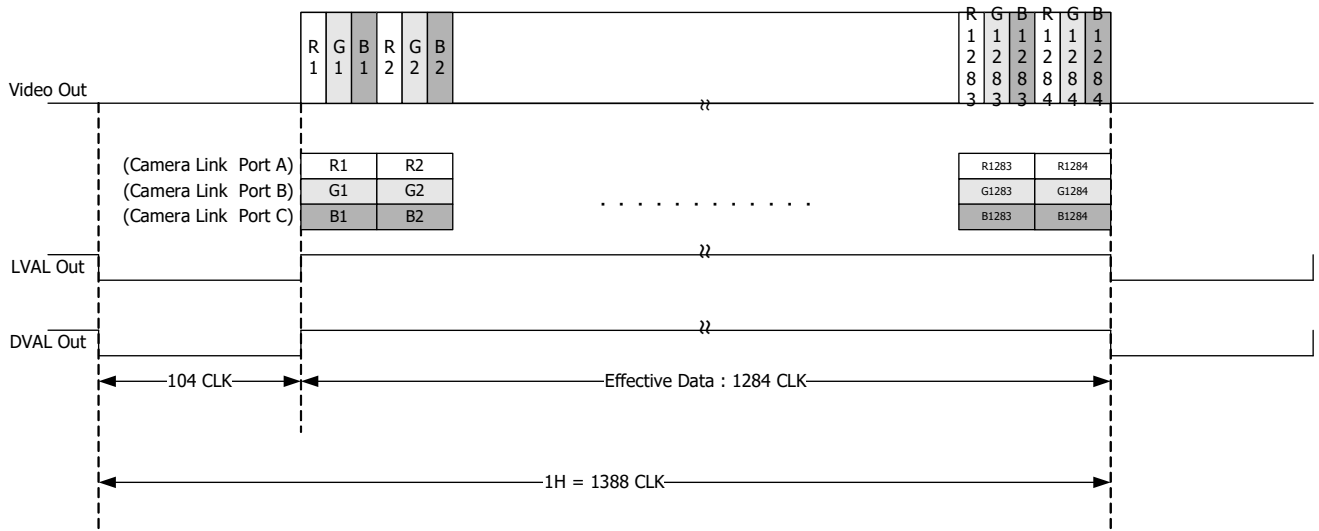

Camera Link CLK : 74.25MHz

5.10. Vertical Synchronous Signals Timing (Base Configuration 24bit – RGB)

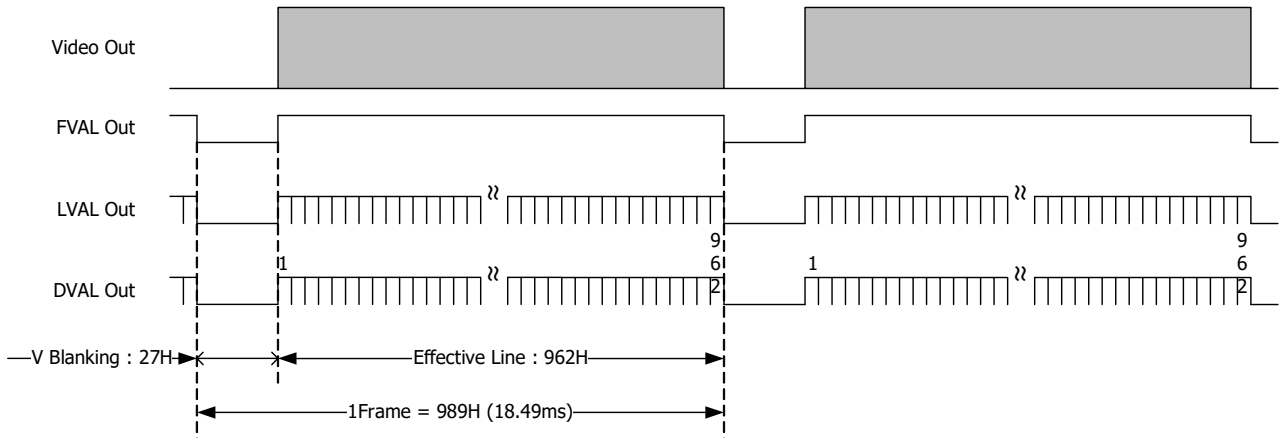

1H = 18.694 us

5.11. Horizontal Synchronous Signals Timing (Base Configuration 24bit – RGB / Fixed trigger shutter mode)

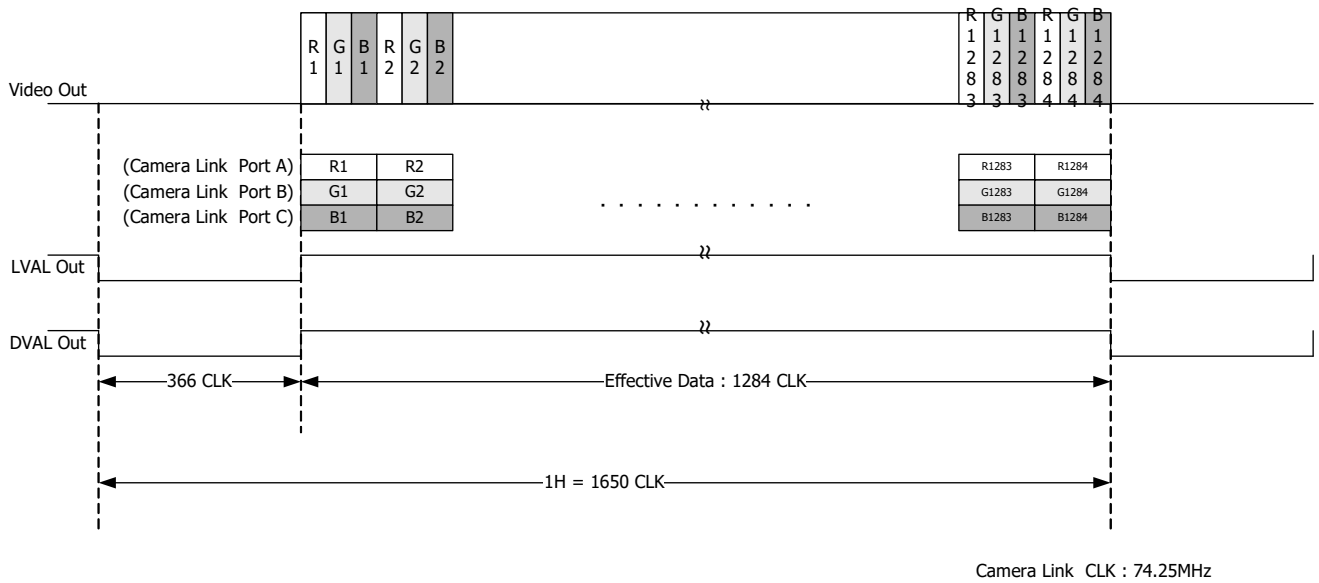

5.12. Vertical Synchronous Signals Timing (Base Configuration 24bit – RGB / Fixed trigger shutter mode)

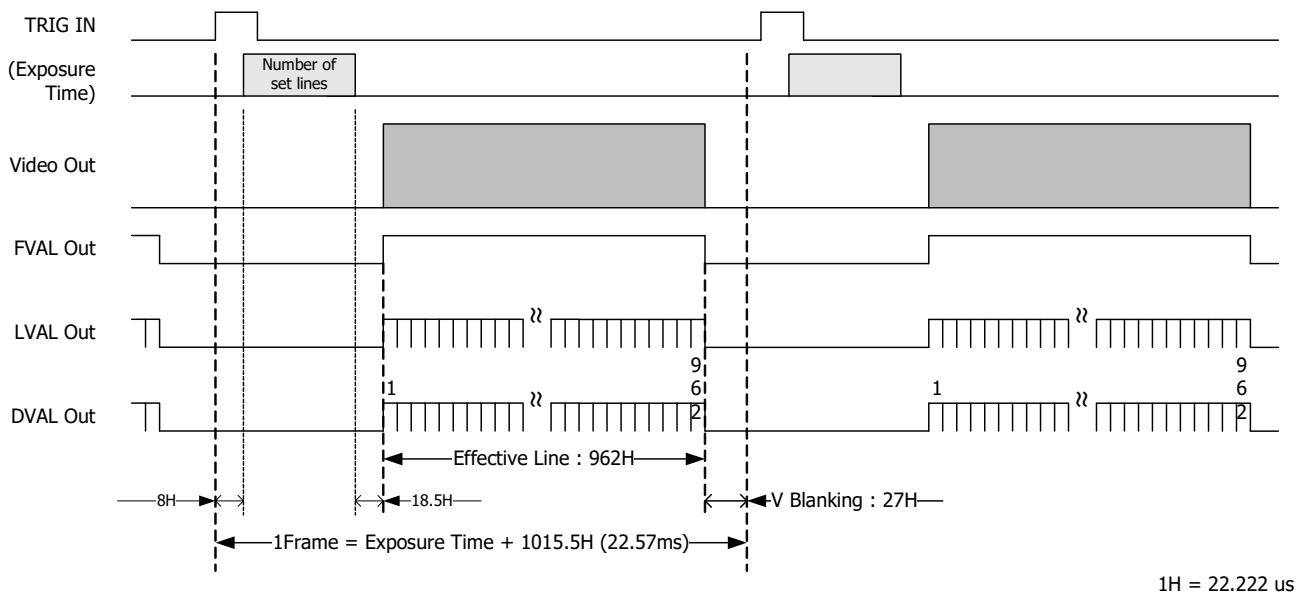

5.13. Output format

1Tap Base Configuration

ID1MB-CL

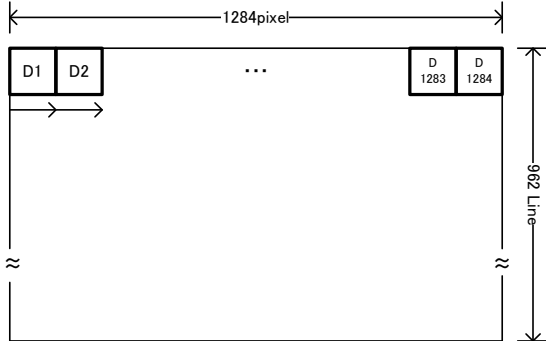

ID1MC-CL

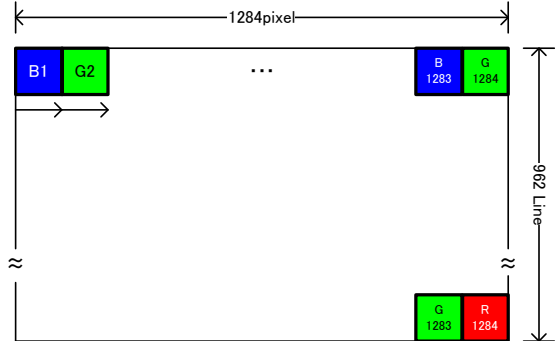

2Tap Base Configuration

ID1MB-CL

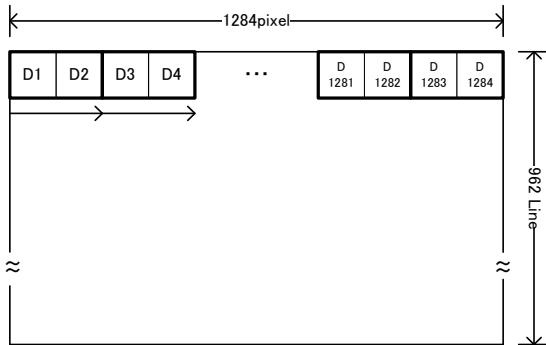

ID1MC-CL

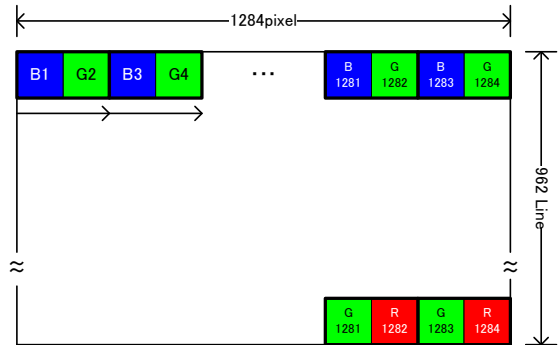

Base Configuration 24bit – RGB

Only ID1MC-CL

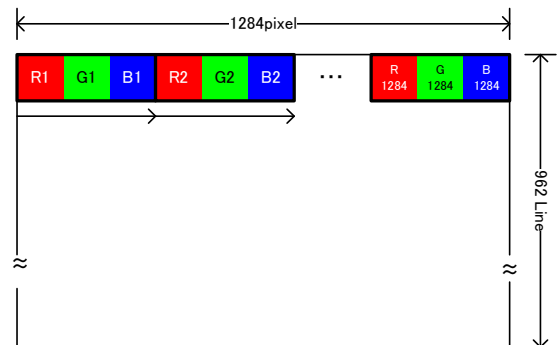

5.14.Fixed Trigger Shutter Mode

- This is the mode to start exposure with external input trigger signals, and set the exposure time with serial commands.
- Delay time (Exposure Time Delay) from detecting trigger edge in the camera to starting exposure is as below.

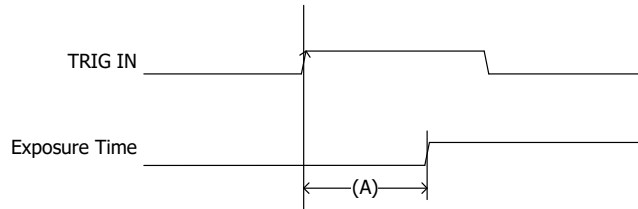

Exposure time delay (A)
 $178 \text{ us} (8H) * 1H = 22.22\text{us}$

- Do not input a trigger signal with an exposure setting that will start the next image output during the exposure period and before the image output is completed.
 Possible trigger input interval = Exposure Time Delay + Exposure Time + Effective Line + 18.5H + 27H

Example: Exposure time 1 / 1000s (45H), effective line 962H
 Exposure Time Delay 8H + Exposure Time 45H + Effective Line 962H + 45.5H
 = 23.57ms (1060.5H)
 * 1H = 22.22us

- Trigger inputs during the exposure period (B) and during image output (C) are ignored in the camera.

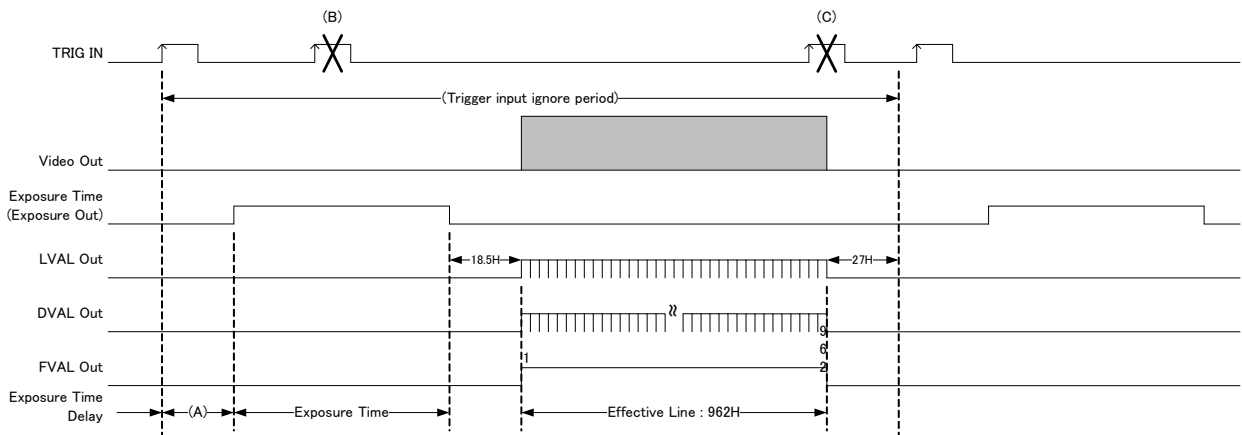

6. Scan Mode

6.1. Partial scan mode

- It is possible to increase the frame rate by limiting the vertical scan area.
- Set the partial area with the communication command.
 - Vertical start position address: 40 --41
 - Partial scan number of valid lines Address: 50 – 51
- Does not work in VGA mode or QVGA mode.

Setting Example

Normal shutter mode

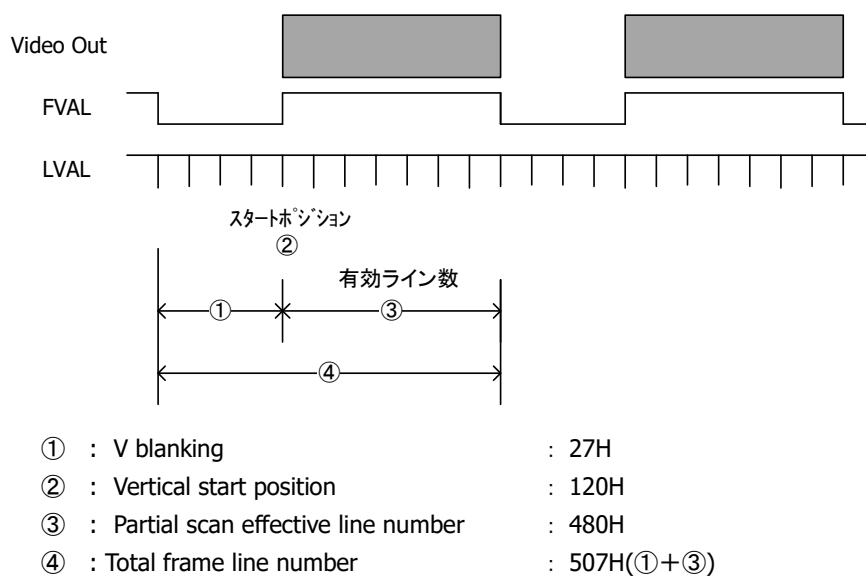

Fixed trigger shutter mode *Example : Exposure time : 1/1000s(45H)

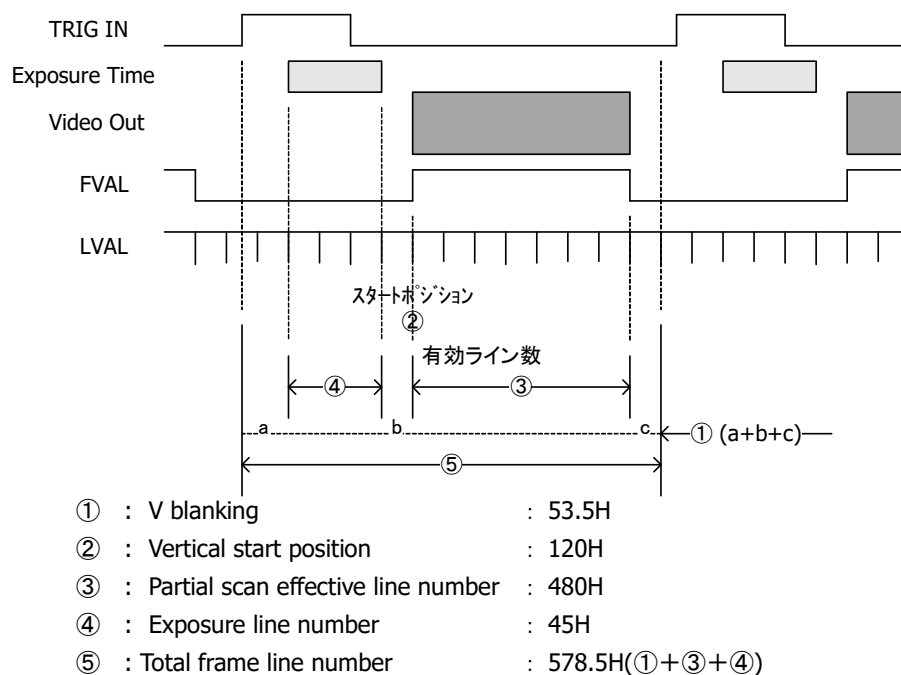

- Set the start position to 2 x n and the number of valid lines to 4 x n based on 0 (maximum is fixed at 962).
However, the vertical start position + number of effective lines <= 962 must be satisfied.

- Total number of frames for several hours

Normal shutter mode

= Number of V blanking lines (27H) + Number of valid lines

Fixed trigger shutter mode

= Exposure time + Number of V blanking lines (53.5H) + Number of effective lines

- Frame Rate = 1 / (Total lines x Time for 1 line)

Time for 1 line = 18.69us (Normal shutter mode) / 22.22us (Fixed trigger shutter mode)

- Example

Normal shutter mode

Effective lines	Frame rate (Total lines)
4H (min)	1725.6fps (31H)
240H, QVGA mode	200.3 (267)
320H	154.1 (347)
480H, VGA mode	105.5 (507)
640H	80.201 (667)
720H	71.61 (747)
962H (max:Full frame)	54.08 (989)

Fixed trigger shutter mode (*Exposure time : 1/1000s (45H))

Effective lines	Exposure lines	Frame rate (Total lines)
4H (min)	45H	439.02fps (102.5H)
240H, QVGA mode	45H	132.93 (338.5)
320H	45H	107.52 (418.5)
480H, VGA mode	45H	77.78 (578.5)
640H	45H	60.93 (738.5)
720H	45H	54.97 (818.5)
962H (max:Full frame)	45H	42.43 (1060.5)

The frame rate of the fixed shutter trigger mode varies depending on the input trigger signal.

This is an example of the MAX frame rate that can be set.

6.2. Binning mode

- 2 horizontal pixels and 2 vertical pixels are added (averaged) to 1 pixel and output.
- The number of pixels is 640 x 480, and the amount of transferred data can be reduced without changing the angle of view.
- The frame rate is the same as the output of all pixels.
- Set to binning mode with a communication command.

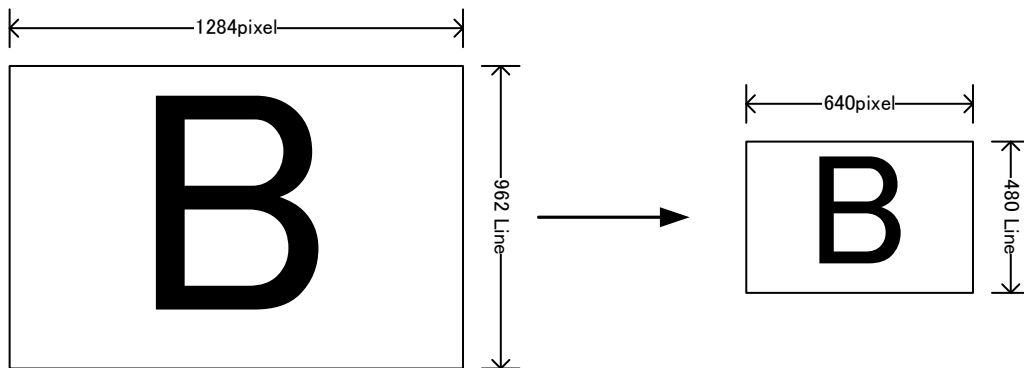

6.3.VGA mode

- VGA mode 640 x 480 pixels are cut out from all pixels and output.
- There are fewer lines and the frame rate goes up to 105.51fps.
- Set to VGA mode with a communication command.
- The start position can be set by communication command both horizontally and vertically.

Horizontal start position address: 42 – 43 h

Vertical start position address: 40 – 41 h * Similar to partial scan mode

- Set the start position to 2 x n.

However,

Satisfy the horizontal start position + 640 <= 1284.

Satisfy the vertical start position + 480 <= 962.

* The initial data of the horizontal start position is 0000 h and the center position is 0140 h (320).

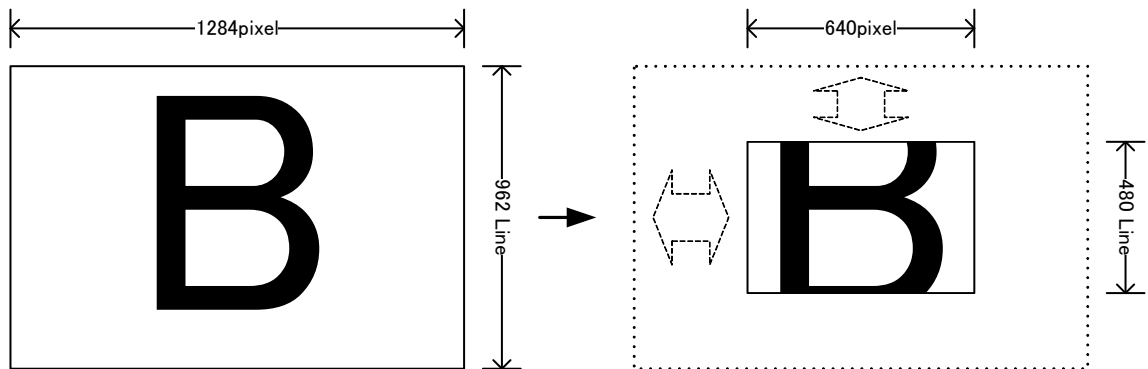

- The shutter mode operates as follows.

Address: 01 h

Normal shutter mode

Data 00-02 h: 1/105s (OFF)

Subsequent data is the same as in full frame scan mode

Fixed shutter trigger mode

Data 00-01 h: 1 / 89s (OFF)

Subsequent data is the same as in full frame scan mode

Data: 0F h Manual shutter,

Address: 24 – 25 h, data (set value) 01E2 h (482) or higher

6.4.QVGA mode

- QVGA 320 x 240 pixels are cut out from all pixels and output.
- There are fewer lines and the frame rate goes up to 200.35fps.
- Set to QVGA mode with a communication command.
- The start position can be set by communication command both horizontally and vertically.

Horizontal start position address: 42 – 43 h

Vertical start position address: 40 – 41 h * Similar to partial scan mode

- Set the start position to 2 x n.

However,

Satisfy the horizontal start position + 320 <= 1284.

Satisfy the vertical start position + 240 <= 962.

* The initial value of the data for the horizontal start position is 0000 h, and the center position is 01E0 h (480).

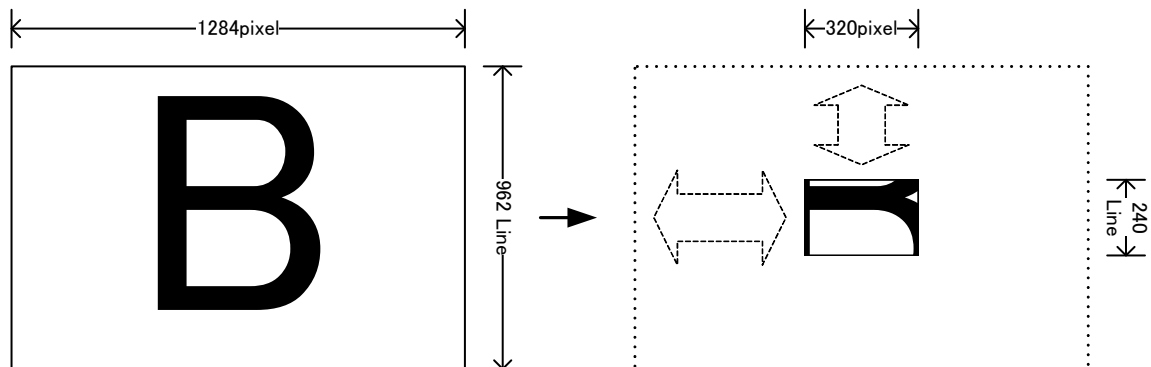

- The shutter mode operates as follows.

Address: 01 h

Normal shutter mode

Data 00 ~ 03 h: 1 / 200s (OFF)

Subsequent data is the same as in full frame scan mode

Fixed shutter trigger mode

Data 00-03 h: 1/171s (OFF)

Subsequent data is the same as in full frame scan mode

Data: 0F h Manual shutter,

Address: 24 – 25 h, data (set value) 02D2 h (722) or higher

7. Remote Communication

Communication Settings	
Baud Rate	: 9600bps (Initial Setting)
Data	: 8bit
Stop bit	: 1bit
Parity	: None
XON / XOFF	: No Control

- Send Command Format (Host to Camera)

If send a command, set the command and parameter between STX and ETX.

STX (02H)	Command (2byte)	Parameter(ASCII code) (20H-7FH)	ETX (03H)

- Return Command Format (Camera to Host)

Normally, a camera returns a control code which is ACK or NAK.

If return value has a text message, the message is between STX and ETX.

ACK (06H)	... Succeed
--------------	-------------

NAK (15H)	... Fail
--------------	----------

STX (02H)	command (2byte)	parameter(ASCII code) (2FH- 7FH)	ETX (03H)	... return message

- Command list

Command	Function
SR	Set some values of register
GR	Get some values of register
SU	Set a user's data
GU	Get a user's data
CS	Save all configurations
CR	Restore all configurations
QM	Get a model name
QS	Get a serial number
QV	Get a firmware version
QE	Get a detail of error information

7.1.Command Specifications

1) Set some values of resister

【Command】 Set : Resister

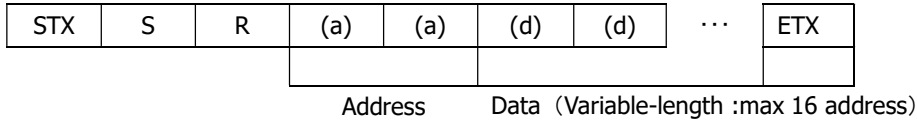

【Return Value】

Succeed	...	ACK
Fail	...	NAK

2) Get some value of resister

【Command】 Get : Resister

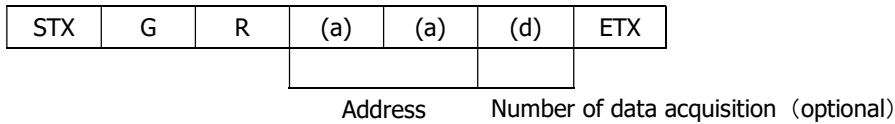

【Return value】

Succeed	...	STX	A	R	(d)	(d)	...	ETX
		Data (Data length depends on the number of acquisitions)						
Fail	...	NAK						

【Remarks】

The command gets some value of register of the specified address. The number of the acquisition is between '0' and 'F' (Hexadecimal).

If appoint '0' at the address, the command send data of 16 address. If the command is omitted at the address, the command send an address.

3) Set User's data

5) Save all configurations

【Command】 Configuration : Save

STX	C	S	ETX
-----	---	---	-----

【Return Value】

Succeed	...	ACK
Fail	...	NAK

6) Restore all configurations

【Command】 Configuration : Restore

STX	C	R	ETX
-----	---	---	-----

【Return Value】

Succeed	...	ACK
Fail	...	NAK

7) Get a model name

【Command】 Query : Model name

STX	Q	M	ETX
-----	---	---	-----

【Return Value】

Succeed	...	STX	R	M	(d)	(d)	...	ETX
					Model name (Fixed length: 16byte)			
Fail	...	NAK						

8) Get a serial number

【Command】 Query : Serial number

STX	Q	S	ETX
-----	---	---	-----

【Return Value】

Succeed	...	STX	R	S	(d)	(d)	...	ETX
					Serial Number(Fixed length: 8byte)			
Fail	...	NAK						

9) Get a firmware version

【Command】 Query : Version

STX	Q	V	ETX
-----	---	---	-----

【Return Value】

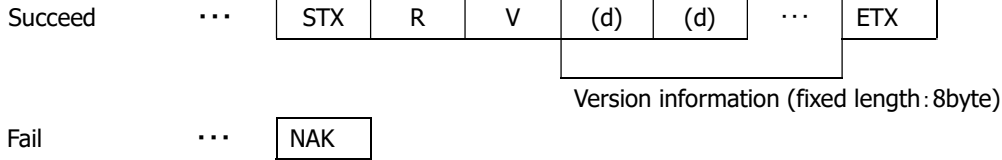

10) Get a detail of error information

【Command】 Query : Error

STX	Q	E	ETX
-----	---	---	-----

【Return Value】

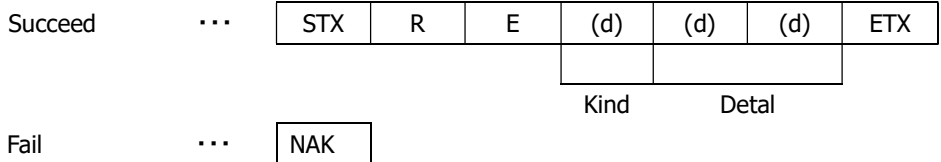

Kind	Detail
0: No Error	00: Normal result
1: Communication Protocol Error	00: The command is undefined.
	01: The command length is more than defined.
	02: The address is undefined.
	03: The value of data is undefined.
	04: The length is more than defined.
	05: The table number is undefined.
	06: The string of user data was abnormal.
2: Internal Control Error	00: Internal control is abnormal.
	01: A read only address was written by the command.
	02: A protected address was written by the command.
	03: Out of range address was written by the command.
	04: The selected table number is abnormal.
	05: The value of the man acquisition area is abnormal.
	06: A function is not implemented.

7.2.Control Example

1) How to check trigger shutter mode. (The command gets a value from address 04)

【Send Command】

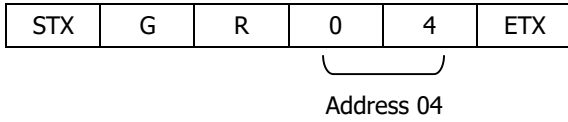

【Return value form camera】

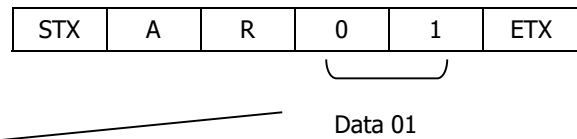

【Receive Return Value】

The camera is working with a trigger shutter mode, because the command received a 01 from the camera.

2) How to check trigger shutter mode. (The command gets consecutive 2 bytes values from address 20)

【Send Command】

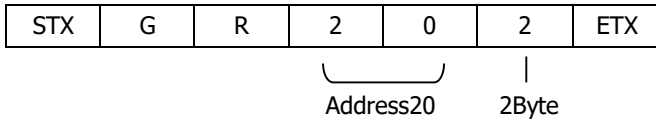

【Receive return value】

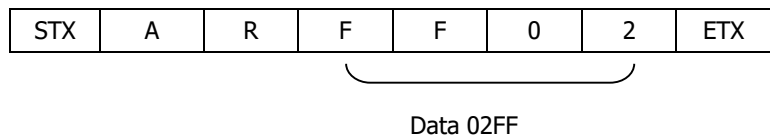

【Receive return value】

The shutter mode of camera is working +12dB, because the command received a 02FF(767) from the camera.

3) How to set partial scan mode. (The command sets 01 for address 08)

【Send Command】

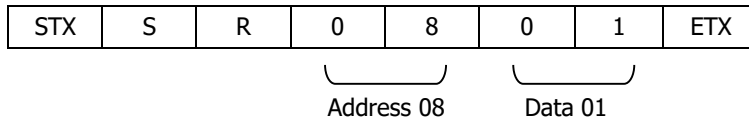

【Return value form camera】

ACK

【Receive Return Value】

The command finished normally, because the command received ACK from the camera.

4) How to set 01FF for manual shutter. (The command set 01FF for address 24)

【Send Command】

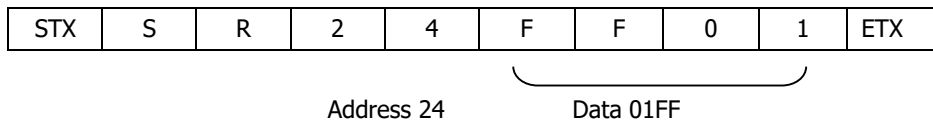

【Return value form camera】

ACK

【Receive Return Value】

The command finished normally, because the command received ACK from the camera.

5) How to save configurations of a camera. (The command send CS)

【Send Command】

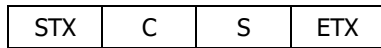

【Return value form camera】



【Receive Return Value】

The command finished normally, because the command received ACK from the camera.

6) How to restore the camera to initial settings. (The command send CR)

【Send Command】

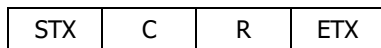

【Return value form camera】

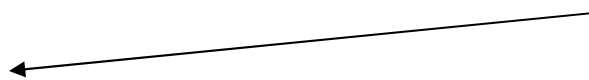

【Receive Return Value】

The command finished normally, because the command received ACK from the camera.

7) How to get detail of a communication error.

【Send Command】

STX	G	R	@	0	ETX
-----	---	---	---	---	-----

Set the address invalid value

【Return value form camera】

NAK

【Receive return value】

The command finished abnormally, because the command received 'NAK' from the camera.
When the command did not finish normally, retry to send command or send to get detail of a detail error command.

【Send Command】

STX	Q	E	ETX
-----	---	---	-----

【Return value form camera】

STX	R	E	1	0	2	ETX
-----	---	---	---	---	---	-----

Kind1 Detail 02

【Receive Return Value】

The 'GR' command accessed invalid address , because the error command received kind '1' and detail '02'.

8. Function Setting

Function	Address(Hex)	Data(Hex)		
Gain mode	00	00:	0dB	
		01:	6dB	
		02:	12dB	
		03:	Manual gain	
		04:	Auto gain *Manual gain mode (Fixed trigger shutter mode, Partial scan mode)	
		05:	AE Lock Locks to the current gain value in auto gain mode, After locking, it will be in manual gain mode. * If the shutter mode is auto shutter, the shutter mode will also be locked to the current exposure time and the manual shutter mode will be set.	
Shutter mode	01		Normal shutter mode	Fixed trigger shutter mode
		00:	1/54s(OFF)	1/45s(OFF)
		01:	1/75s	1/75s
		02:	1/100s	1/100s
		03:	1/150s	1/150s
		04:	1/350s	1/350s
		05:	1/500s	1/500s
		06:	1/1000s	1/1000s
		07:	1/2500s	1/2500s
		08:	1/5000s	1/5000s
		09:	1/7500s	1/7500s
		0A:	1/10500s	1/9000s
		0B:	1/13000s	1/11250s
		0C:	1/18000s	1/15000s
		0D:	1/54000s	1/45000s
		0E:	1/54000s	1/45000s
		0F:	Manual shutter (Address 24-25)	
		10:	Auto shutter In fixed trigger shutter mode and partial scan mode, The mode will be changed to manual shutter mode.	
11:	AE Lock Locks to the current exposure time in auto shutter mode, After locking, it will be in manual shutter mode. * If the gain mode is auto gain, the gain mode also locks to the current gain value and becomes the manual gain mode.			

Function	Address(Hex)	Data(Hex)	
White balance mode (only Color model)	02	00:	THRU
		01:	3200K
		02:	THRU(Spare)
		03:	Manual white balance
		04:	Auto white balance In fixed shutter trigger mode and partial scan mode, The mode is changed to manual white balance mode.
		05:	AWB Lock It locks to the current white balance in the auto white balance mode, and after locking, it becomes the manual white balance mode.
AE level	03	00:	0dB Set the brightness level of auto gain mode and auto shutter mode.
		01:	- 6dB
		02:	- 4dB
		03:	- 2dB
		04:	0dB
		05:	+ 2dB
		06:	+ 4dB
		07:	+ 6dB
Trigger shutter mode	04	00:	Normal shutter mode (Trigger OFF)
		01:	Fixed trigger shutter mode(Address 01:setting the shutter speed) * If the gain mode, shutter mode, and white balance mode are in auto mode, they are automatically changed to manual mode.
Trigger polarity	05	00:	Positive
		01:	Negative
Trigger input	06	00:	CC1
		01:	12 pin connector 11pin-input
Scan mode	08	00:	Full frame scan mode
		01:	Partial scan mode * Gain mode, shutter mode, white balance mode -> Manual mode
		02:	Binning mode
		03:	VGA mode
		04:	QVGA mode
Output mode (* 1)	0A	00:	1Tap Base Configuration
		01:	2Tap Base Configuration
		02:	Base Configuration 24bit – RGB

* 1 Base Configuration 24bit – RGB output : only color model

Function	Address(Hex)	Data(Hex)	
Image Output bit	0B	00:	8bit
		01:	10bit
		02:	12bit
Baud rate (* 2)	10	00:	9600bps
		01:	19200bps
		02:	38400bps
		03:	57600bps
		04:	115200bps
Slow shutter mode	13	00:	OFF Preset shutter (Address01) effective
		01:	1 line step (Address 26-27) Preset shutter (Address 01) is disabled. Time for line Normal shutter mode 18.694us Fixed trigger shutter mode 22.222us
		02:	2 line step Time for line Normal shutter mode 37.387us Fixed trigger shutter mode 44.444us
		03:	4 line step Time for line Normal shutter mode 74.774us Fixed trigger shutter mode 88.889us
		04:	8 line step Time for line Normal shutter mode 149.549us Fixed trigger shutter mode 177.778us
Image up / down / left / right inversion	18	00:	Normal
		01:	Flip upside down
		02:	Flip horizontal
		03:	Upside down, left and right
LED ON/OFF	1B	00:	OFF
		01:	ON

* 2 When changing the settings, save the data and restart the camera.

Function	Address(Hex)	Data(Hex)	
Manual gain	20-21	0 – 2FF:	min:0(0H) - max:767(2FFH) 0: x1(0dB) , 256: x2(+6dB), 767: x4(+12dB)
Manual shutter	24-25	LLHH:	min:0(0H) - max:984(3D8H) Shutter time : (985 – setting value) × time for line Normal shutter mode Shutter time = (985 – setting value) × 18.69us min:0= 18.41ms (1/54.3s) , max:984 = 18.69us (1/54000s) Fixed trigger shutter mode Shutter time = (985 – setting value) × 22.22us min:0= 21.89ms (1/45.7s) , max:984 = 22.22us (1/45000s) * The only exception is the set value: 983, which does not apply to the above formula. The exposure time is the same as the max value 984.
Line step slow shutter	26-27	LLHH	min:0(0H) - max:64550(FC26H) Shutter time : (985 + setting value) × time for line 1 frame time is (989 + set value) × line time. (See address 13 for each step line time) Ex . 8 line step Normal shutter mode Shutter time = (985 + setting value) × 149.55us min:0=147.31ms , max:64550=9801ms Fixed trigger shutter mode Shutter time = (985 + setting value) × 177.78us min:0=175.11ms , max:64550=11651ms
Manual white balance R (Only color model)	28-29	LLHH:	min:0(0H) - max:767(2FFH) 0: x1(0dB), 767: x4(+12dB)
Manual white balance B (Only color model)	2A-2B	LLHH:	min:0(0H) - max:767(2FFH) 0: x1(0dB), 767: x4(+12dB)
Manual white balance G (Only color model)	2C-2D	LLHH:	min:0(0H) - max:767(2FFH) 0: x1(0dB), 767: x4(+12dB)

Function	Address(Hex)	Data(Hex)	
Vertical start position	40-41	LLHH:	min:0(0H) - max:960(3C0H) * Setting value : 2 x n
Horizontal start position	42-43	LLHH:	min:0(0H) - max:960(3C0H) * Setting value : 2 x n
Partial scan Effective line number	50-51	LLHH:	min:2(2H) - max:962(3C2H) * When not in use, set the number of valid lines = 962 (3C2H). * To enable partial scan, change the data at address 08 to 01.

※ LLHH : The data set with 2 Byte shall be set with Low Byte first, then set with High Byte.

< Example > Manual Gain(Address 24-25) ->767(02FFH)

STX SR 24 FF 02 ETX

8. Dimensions

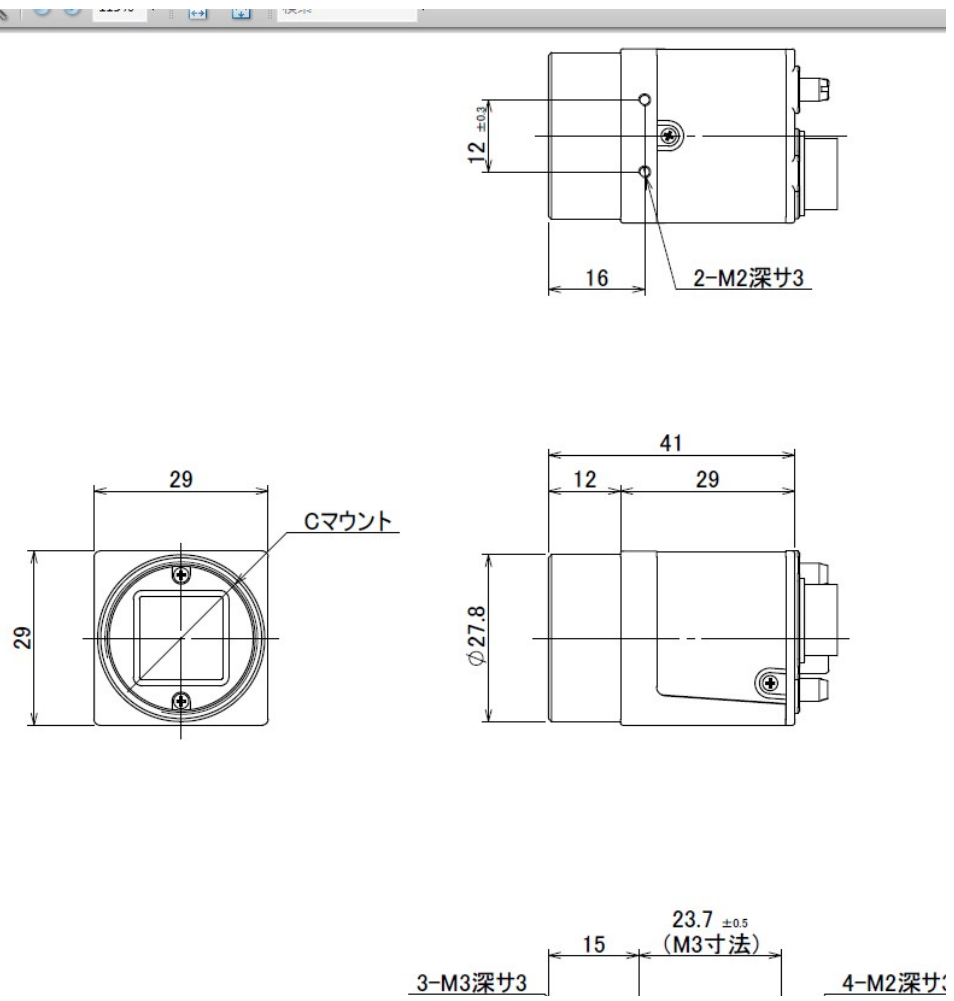

(単位:mm)

9. Initial Setting

Function	Address	Data	
Gain mode	00	00:	0dB
Shutter mode	01	00:	1/54s(OFF)
White Balance (Color model)	02	00:	THRU
AE level	03	00:	0dB
Trigger Mode	04	00:	Normal (Trigger OFF)
Trigger Polarity	05	00:	Positive
Trigger Input	06	00:	CC1
Partial Scan Mode	08	00:	Full Frame
Camera Output Mode	0A	00:	1Tap Base Configuration
Output Data Selection	0B	00:	8bit
Baud Rate	10	00:	9600bps
Slow shutter mode	13	00:	OFF
Output Image Flip	18	00:	Normal
LED ON/OFF	1B	01:	ON
Manual Gain	20-21	0000:	0dB
Manual Shutter	24-25	0000:	Shutter(OFF)
Line step slow shutter	26-27	0000:	Shutter(OFF)
Manual White Balance R (Color model)	28-29	0000:	0dB
Manual White Balance G (Color model)	2A-2B	0000:	0dB
Manual White Balance B (Color model)	2C-2D	0000:	0dB
Vertical Start Position	40-41	0000:	Start Position 0
Horizontal Start Position	42-43	0000:	Start Position 0
Partial Scan Effective Lines	50-51	03C2:	Effective lines 962

10. Cases for Indemnity (Limited Warranty)

We shall be exempted from taking responsibility and held harmless for damage or losses incurred by the user in the following cases.

- In case damage or losses are caused by fire, earthquake, or other acts of God, acts by third party, deliberate or accidental misuse by the user, or use under extreme operating conditions.
- In case indirect, additional, consequential damages (loss of business interests, suspension of business activities) are incurred as result of malfunction or non-function of the equipment, we shall be exempted from responsibility for such damages.
- In case damage or losses are caused by failure to observe the information contained in the instructions in this product specification & operation manual.
- In case damage or losses are caused by use contrary to the instructions in this product specification & operation manual.
- In case damage or losses are caused by malfunction or other problems resulting from use of equipment or software that is not specified.
- In case damage or losses are caused by repair or modification conducted by the customer or any unauthorized third party (such as an unauthorized service representative).

11. CMOS Pixel Defect

IDULE compensates the noticeable CMOS pixel defects found at the shipping inspection prior to our shipment. On very rare occasions, however, CMOS pixel defects might be noted with time of usage of the products.

Cause of the CMOS pixel defects is the characteristic phenomenon of CMOS itself and IDULE is exempted from taking any responsibilities for them. Should you have any questions on CMOS pixel defects compensation, please contact us.

12. Product Support

When defects or malfunction of our products occur, and if you would like us to investigate on the cause and repair, please contact your distributors you purchased from to consult and coordinate.