25M CMOS Camera

ID25MGB-CL (B/W)

ID25MGC-CL (COLOR)

Technical Manual

iDule Corporation

Table of Contents

	PAGE
1. Product Outline	3
2. Handling Precautions	3
3. Specification	4
3.1. General Specification.....	4
3.2. Camera Output Signal Specification	5
3.3. Spectral Response (Representative Value).....	6
4. Connector	7
4.1. Camera Link Connector 12226-1100-00PL (3M)	7
4.2. Power LED	8
4.3. 12pin Connector HR10A-10R-12PB (HIROSE) (CN1)	8
4.4. Power input to camera	8
5. Timing Chart	9
5.1. Horizontal Synchronous Signals Timing (2Tap Base Configuration : 5.6fps)	9
5.2. Vertical Synchronous Signals Timing (2Tap Base Configuration : 5.6fps)	9
5.3. Horizontal Synchronous Signals Timing (3Tap Base Configuration : 7.5fps)	10
5.4. Vertical Synchronous Signals Timing (3Tap Base Configuration : 7.5fps)	10
5.5. Horizontal Synchronous Signals Timing (4Tap Medium Configuration : 11.3fps).....	11
5.6. Vertical Synchronous Signals Timing (4Tap Medium Configuration : 11.3fps)	11
5.7. Horizontal Synchronous Signals Timing (8Tap Full Configuration : 22.6fps)	12
5.8. Vertical Synchronous Signals Timing (8Tap Full Configuration : 22.6fps).....	12
5.9. Output format	13
5.10. Fixed Trigger Shutter Mode	14
5.11. Pulse Width Trigger Shutter Mode.....	15
6. Partial Scan Mode	16
7. Remote Communication	19
8.1. Command Specifications.....	20
8.2. Control Example	24
8. Function Setting	28
9. Dimensions	31
10. Initial Setting	32
11. Cases for Indemnity (Limited Warranty)	33
12. CMOS Pixel Defect	33
13. Product Support	33

1. Product Outline

ID25MGB-CL/ID25MGC-CL is a Camera Link interfaced and 25M resolution camera module. 25M pixels CMOS sensor with diagonal length 18.130mm is utilized. Entire pixels can be read out within 1/22.6s at Full Configuration output.

Features

- Global Shutter CMOS sensor is utilized.
- Camera Link Base , Medium, Full Configuration are supported.
- Fixed trigger shutter mode, pulse width trigger shutter mode are operable.
- Full frame rates are as follows.

2Tap Base Configuration	5.6fps	: 8bit / 10bit /12bit
3Tap Base Configuration	7.5fps	: 8bit
4Tap Medium Configuration	11.3fps	: 8bit / 10bit /12bit
8Tap Full Configuration	22.6fps	: 8bit / 10bit

【Default setting】 8Tap Full Configuration (22.6fps, 8bit)

2. Handling Precautions

The camera must not be used for any nuclear equipment or aerospace equipment with which mechanical failure or malfunction could result in serious bodily injury or loss of human life. Our warranty does not apply to damages or defects caused by irregular and /or abnormal use of the product.

Please observe all warnings and cautions stated below.

Our warranty does not apply to damages or malfunctions caused by neglecting these precautions.

Do not use or store the camera in the following extreme conditions :

- Extremely dusty or humid places.
 - Extremely hot or cold places (operating temperature -5°C to +45°C).
 - Close to generators of powerful electromagnetic radiation such as radio or TV transmitters.
 - Places subject to fluorescent light reflections.
 - Places subject to unstable (flickering, etc.) lighting conditions.
 - Places subject to strong vibration.
-
- Remove dust or dirt on the surface of the lens with a blower.
 - Do not apply excessive force or static electricity that could damage the camera.
 - Do not shoot direct images that are extremely bright (e.g., light source, sun, etc.), and when camera is not in use, put the lens cap on.
 - Confirm the mutual ground potential carefully and then connect the camera to monitors or computers. AC leaks from the connected devices may cause damages or destroy the camera.
 - Do not apply excessive voltage. (Use only the specified voltage.) Unstable or improper power supply voltage may cause damages or malfunction of the camera.
 - The voltage ripple of camera power DC +12V±10% shall be within ±50mV. Improper power supply voltage may cause noises on the video signals.
 - The rising time of camera power supply voltage shall be less than +10V, Max 60ms. Please avoid noises like chattering when rising.
-
-

3. Specification

3.1. General Specification

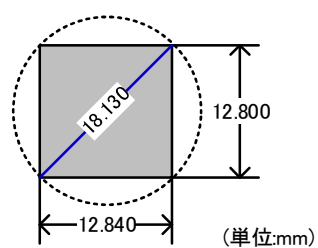
(1) Image Sensor	Device type	Diagonal length 18.130mm, Global Shutter type (GPIXEL GMAX0505)	
	Effective pixel number	5136(H) x 5120(V)	
	Unit cell size	2.5(H) x 2.5(V) μm	
	Image circle	Φ 18.130mm	
 (単位:mm)			
(2) Video Output Frequency	Pixel Clock	79.75MHz	
	2Tap Base Configuration	5.6fps	2728(H)x5184(V) with blanking
	3Tap Base Configuration	7.5fps	2046(H)x5184(V) with blanking
	4Tap Medium Configuration	11.3fps	1364(H)x5184(V) with blanking
	8Tap Full Configuration	22.6fps	682(H)x5184(V) with blanking
(3) Video Output	2Tap Base Configuration		
	3Tap Base Configuration		
	4Tap Medium Configuration		
	8Tap Full Configuration (Initial Setting)		
(4) Output Format	Sensor AD	12bit	
	Camera Link Output	2Tap Base Configuration	:8bit / 10bit / 12bit
		3Tap Base Configuration	:8bit
		4Tap Medium Configuration	:8bit / 10bit / 12bit
8Tap Full Configuration		:8bit / 10bit	
(5) Sensitivity	B/W / Color	F5.6 / F4 2000lx (at shutter speed 1/22.6s (OFF), Gain 0dB, 8tap Full Configuration)	
(6) Power supply input voltage	DC+12V \pm 10% 12 pin connector (Initial Setting) / PoCL		
(7) Power Consumption	max 3.5W (at 8Tap Full Configuration)		
(8) Dimensions	H:45mm W:45mm D:35mm excluding projection		
(9) Weight	Approx. 115g		
(10) Lens Mount	C mount		
(11) Optical Axis Accuracy	Refer to drawing for CMOS optical axis accuracy		
(12) Gain Variable Range	0dB ~ +12dB (Guaranteed range)		
(13) Shutter Speed Variable Range	2Tap Base Configuration	: OFF(1/6s) ~ 1/20,000s	
	3Tap Base Configuration	: OFF(1/8s) ~ 1/25,000s	
	4Tap Medium Configuration	: OFF(1/11s) ~ 1/32,000s	
	8Tap Full Configuration	: OFF(1/23s) ~ 1/43,000s	
(14) Trigger Shutter Mode	Fixed shutter trigger mode / Pulse width shutter trigger mode		
(15) Partial Scan	Mono : Full frame ~ 1Line (1Line/Step) 1area		
	Color : Full frame ~ 2Line (2Line/Step) 1area		
(16) Safety/Quality Standards	RoHS : Confirm to RoHS		
(17) Durability	Vibration	20~200 Hz,98m/s ² (10G), X,Y and Z 3directions (120 min for each direction)	
	Shock	No malfunction shall be occurred with 980m/s ² (100G) for \pm X, \pm Y,and \pm Z, 6 directions. (without package)	
(18) Operation Environment	Temperature	-5 ~ +45°C Humidity 20 ~ 80%RH with no condensation.	
(19) Storage Environment	Temperature	-25 ~ +60°C Humidity 20 ~ 80%RH with no condensation.	

3.2. Camera Output Signal Specification

(1)Video Output Data	Effective Video Output	5136(H) x 5120(V)	
(2)Sync Signal Output	LVAL FVAL DVAL SP	Camera Link (LVDS)	(Exposure output)
	FVAL Exposure		
(3)Camera Control Signal Input	CC2•CC3•CC4	Camera Link (LVDS)	(No Function)
(4)Trigger Input	Polarity	Positive/Negative Selectable	(Address 05h)
	Pulse Width	1HD(Min) ~ (*)	
		<p>*The trigger input signal is sampled n times HD in the camera, and the exposure time is processed n times HD. Trigger pulses shorter than 1 HD are treated as 1 HD wide. Functionally, no upper limitation is set but noises such as dark noises and shadings might be noticeable at long time exposure.</p> <p>2Tap Base Configuration :1HD (34.207us) 3Tap Base Configuration :1HD (25.655us) 4Tap Medium Configuration :1HD (17.103us) 8Tap Full Configuration :1HD (8.552us)</p>	
	CC1(Trigger Input) 12pin Connector(Trigger Input)	Camera Link (LVDS) 12pin Connector 11pin Input (LVTTL)	(Address 06h)
(5)Serial Communication	SerTC SerTFG	Camera Link (LVDS)	(Serial to Camera) (Serial to Frame Grabber)
(6)Video Signals	White Clip Level	3FFh	(at Gain 0dB, 10bit)
	Setup Level	under 002h	
	Dark Shading	Both horizontal and vertical should be under 00Fh	

3.3. Spectral Response (Representative Value)

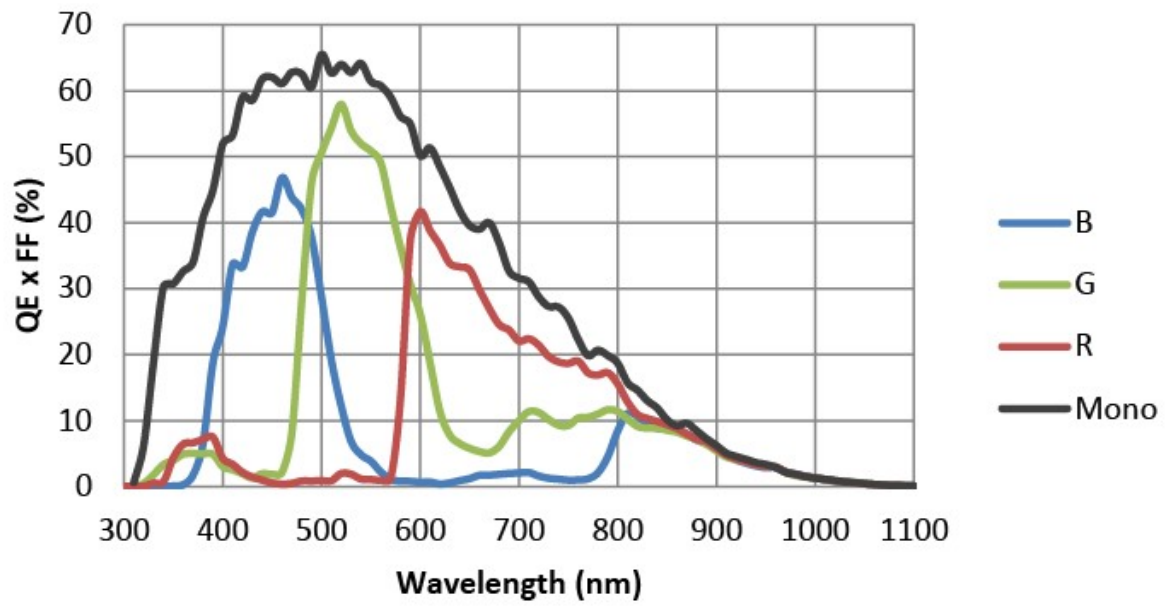

4. Connector

4.1. Camera Link Connector 12226-1100-00PL (3M)

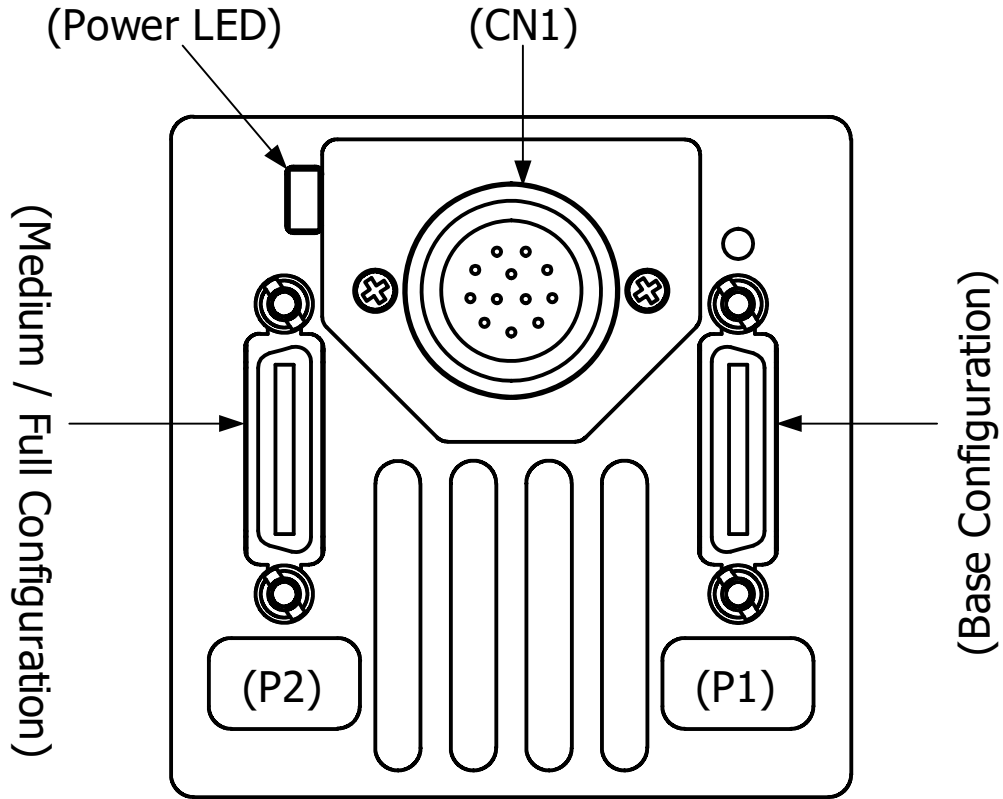

Connector (P2)

PIN No	Name	PIN No	Name
1	+12V(PoCL)	14	GND
2	Y0-	15	Y0+
3	Y1-	16	Y1+
4	Y2-	17	Y2+
5	Yclk-	18	Yclk+
6	Y3-	19	Y3+
7	100Ω	20	Terminated
8	Z0-	21	Z0+
9	Z1-	22	Z1+
10	Z2-	23	Z2+
11	Zclk-	24	Zclk+
12	Z3-	25	Z3+
13	GND	26	+12V(PoCL)

Connector (P1)

PIN No	Name	PIN No	Name
1	+12V(PoCL)	14	GND
2	X0-	15	X0+
3	X1-	16	X1+
4	X2-	17	X2+
5	Xclk-	18	Xclk+
6	X3-	19	X3+
7	SerTC+	20	SerTC-
8	SerTFG-	21	SerTFG+
9	CC1- (Trigger IN -)	22	CC1+ (Trigger IN +)
10	CC2+	23	CC2-
11	CC3-	24	CC3+
12	CC4+	25	CC4-
13	GND	26	+12V(PoCL)

4.2. Power LED

LED lights when the camera is operational. If the power is not supplied or the camera is broken, the LED will not light.
 ※ LED can be turned off (address 1Bh) by serial setting.

4.3. 12pin Connector HR10A-10R-12PB (HIROSE) (CN1)

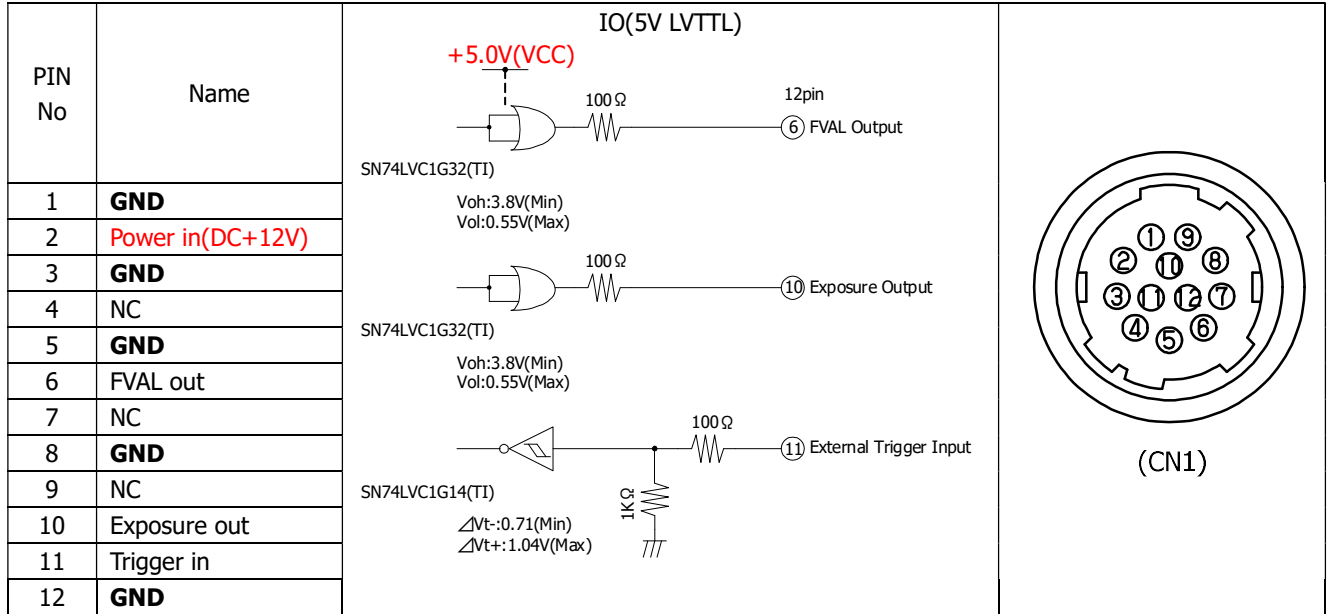

4.4. Power input to camera

Camera rear 12pin connector (2pin) or Camera Link (PoCL) feeding is possible. (Because the power supply is diode-OR connected, there is no problem even if it is powered simultaneously.)

5. Timing Chart

5.1. Horizontal Synchronous Signals Timing (2Tap Base Configuration : 5.6fps)

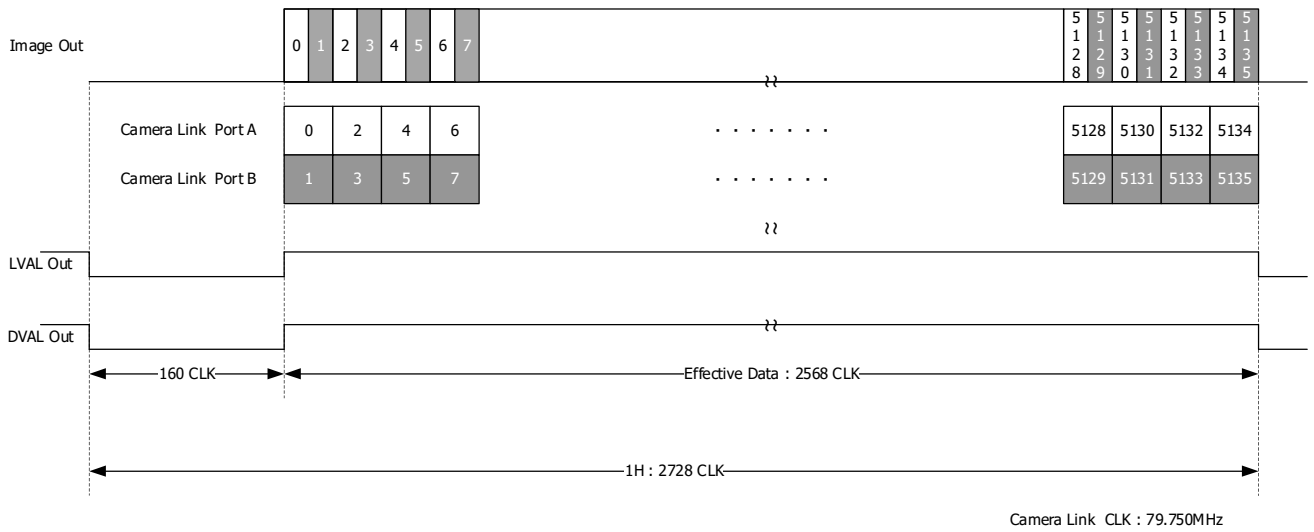

5.2. Vertical Synchronous Signals Timing (2Tap Base Configuration : 5.6fps)

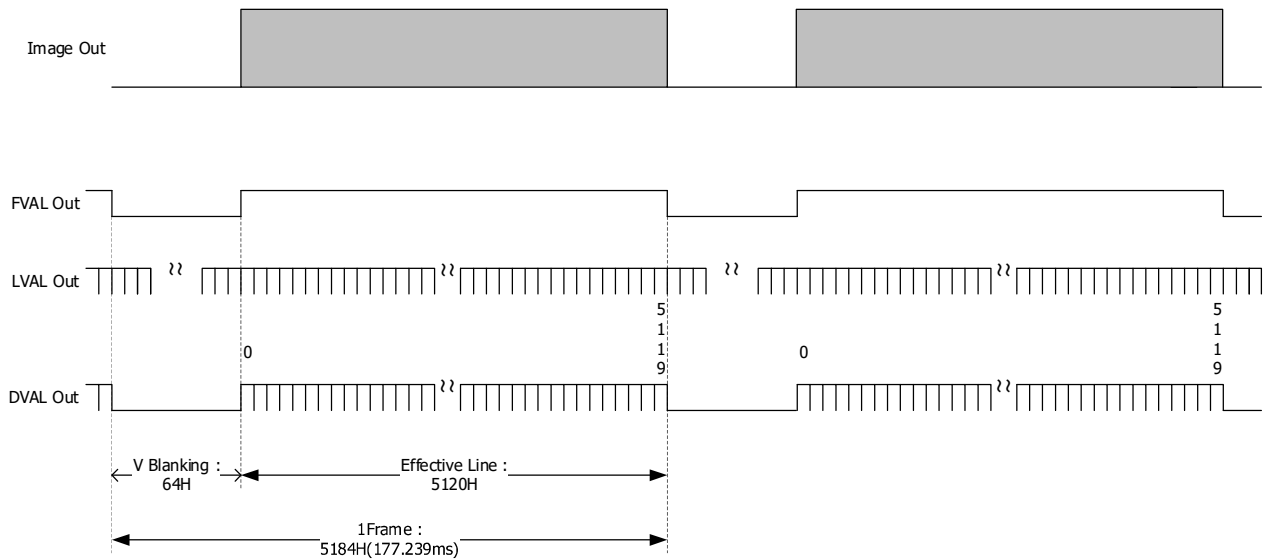

5.3. Horizontal Synchronous Signals Timing (3Tap Base Configuration : 7.5fps)

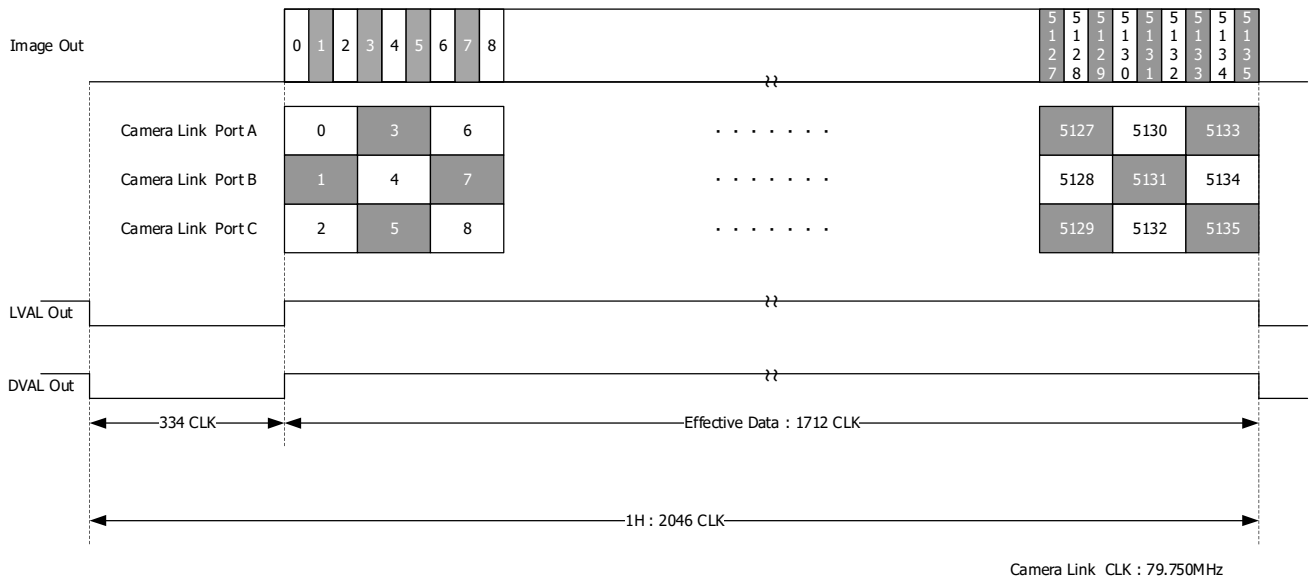

5.4. Vertical Synchronous Signals Timing (3Tap Base Configuration : 7.5fps)

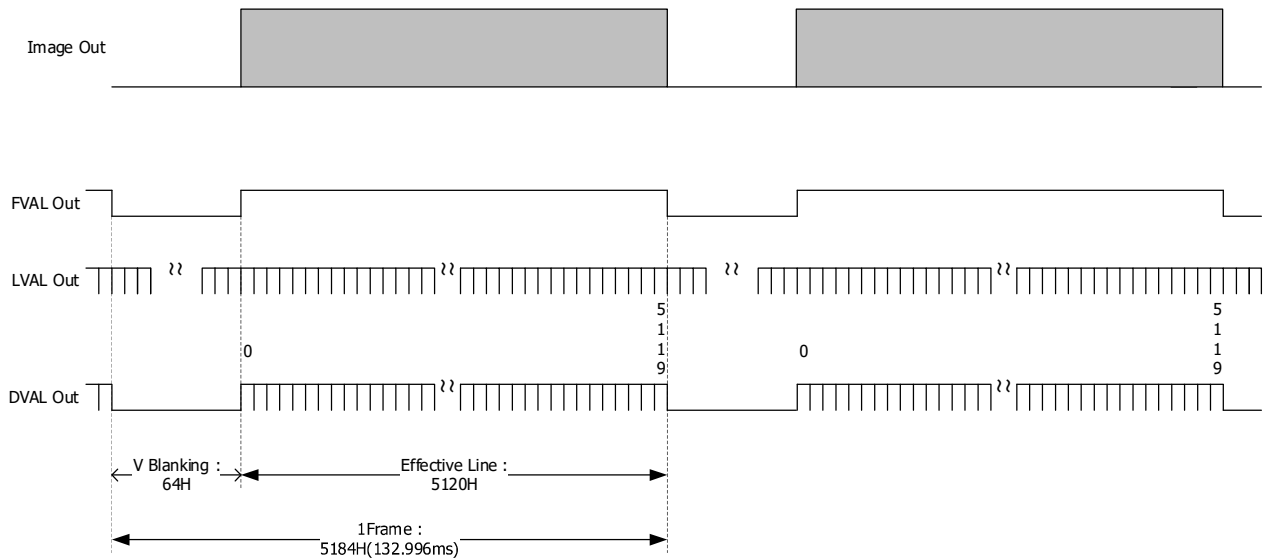

1H = 25.655us

5.5. Horizontal Synchronous Signals Timing (4Tap Medium Configuration : 11.3fps)

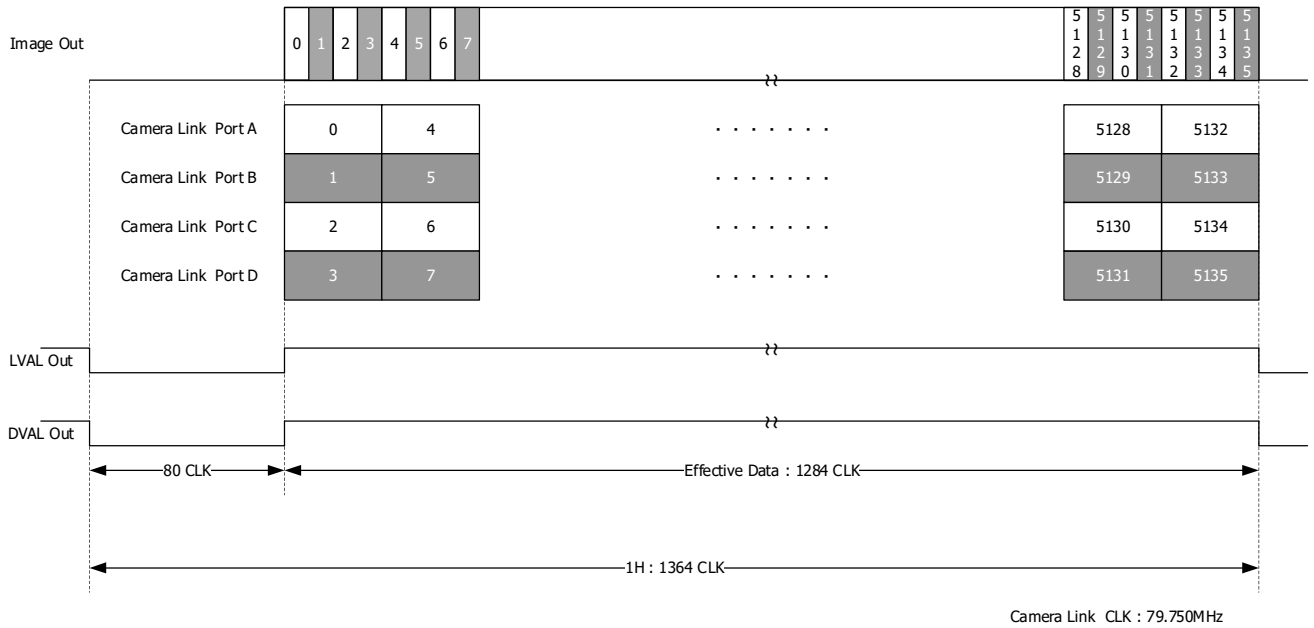

5.6. Vertical Synchronous Signals Timing (4Tap Medium Configuration : 11.3fps)

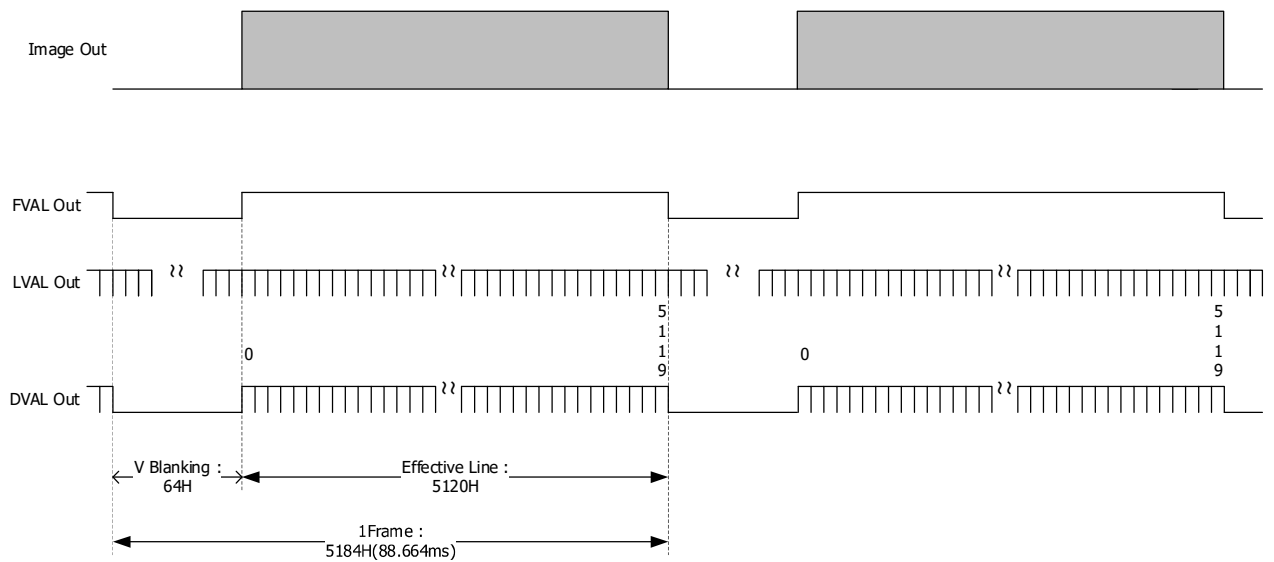

1H = 17.103us

5.7. Horizontal Synchronous Signals Timing (8Tap Full Configuration : 22.6fps)

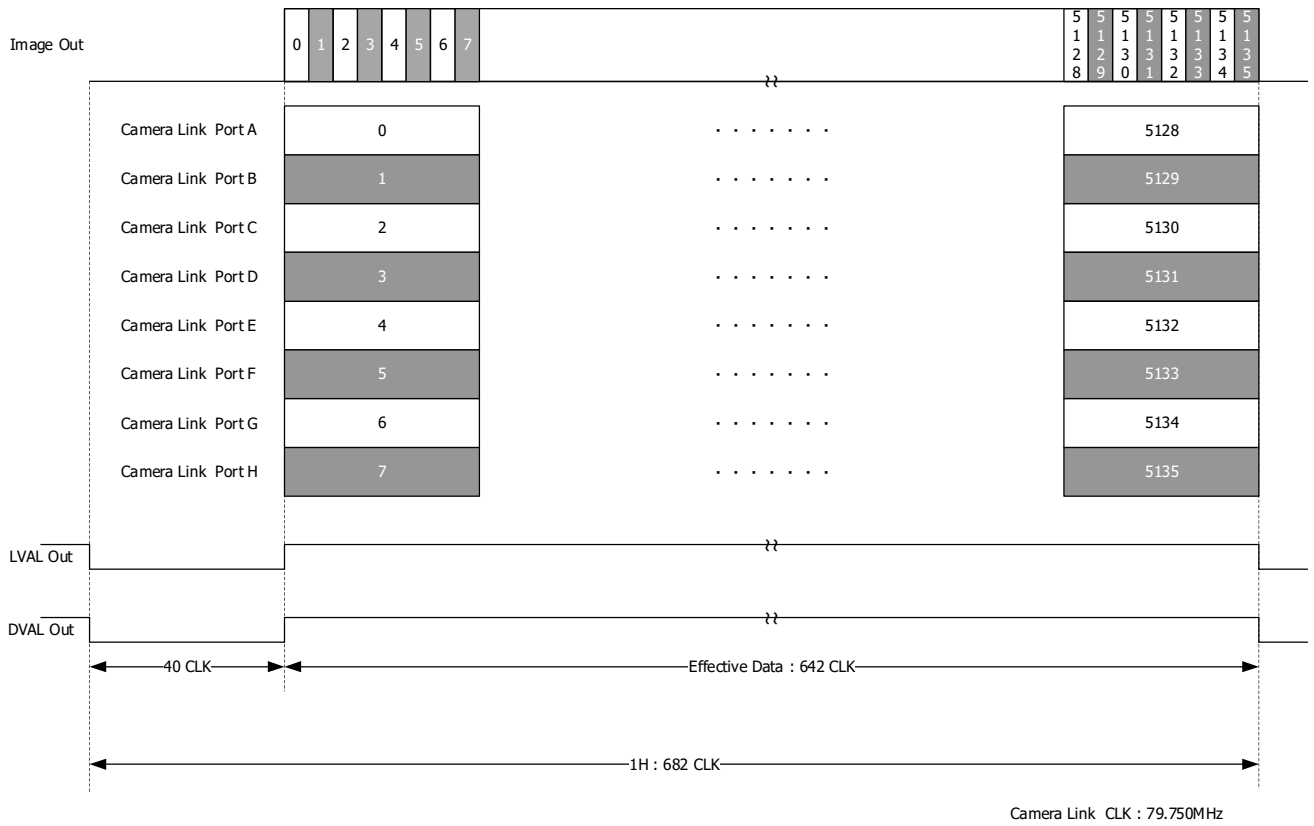

5.8. Vertical Synchronous Signals Timing (8Tap Full Configuration : 22.6fps)

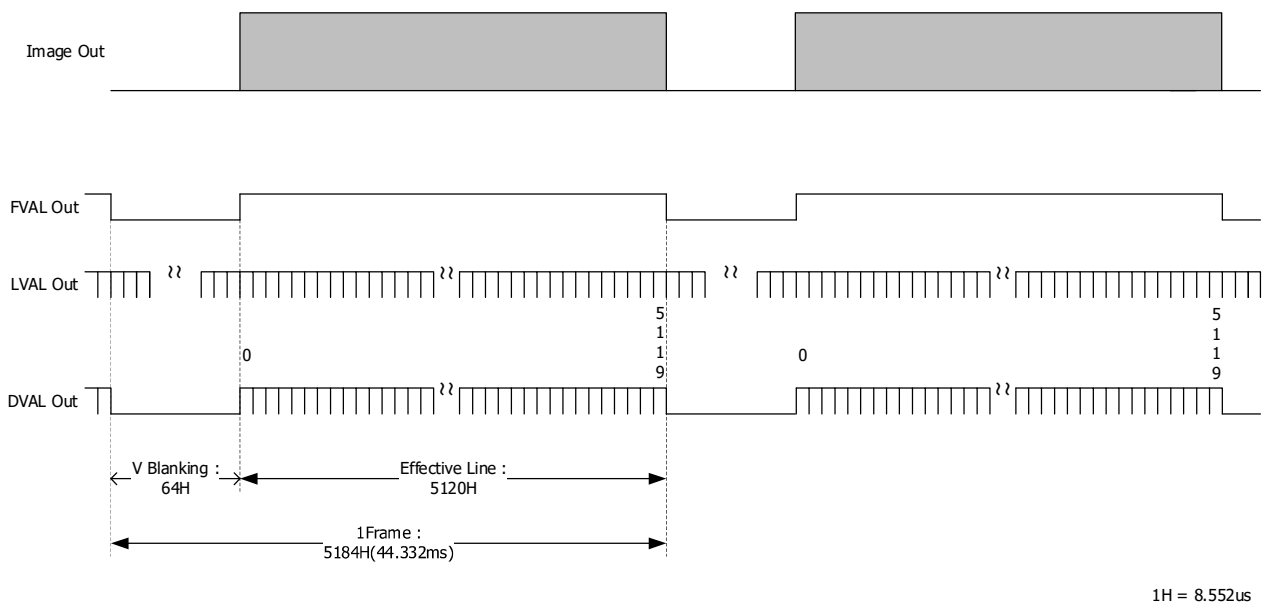

5.9. Output format

(1) B&W

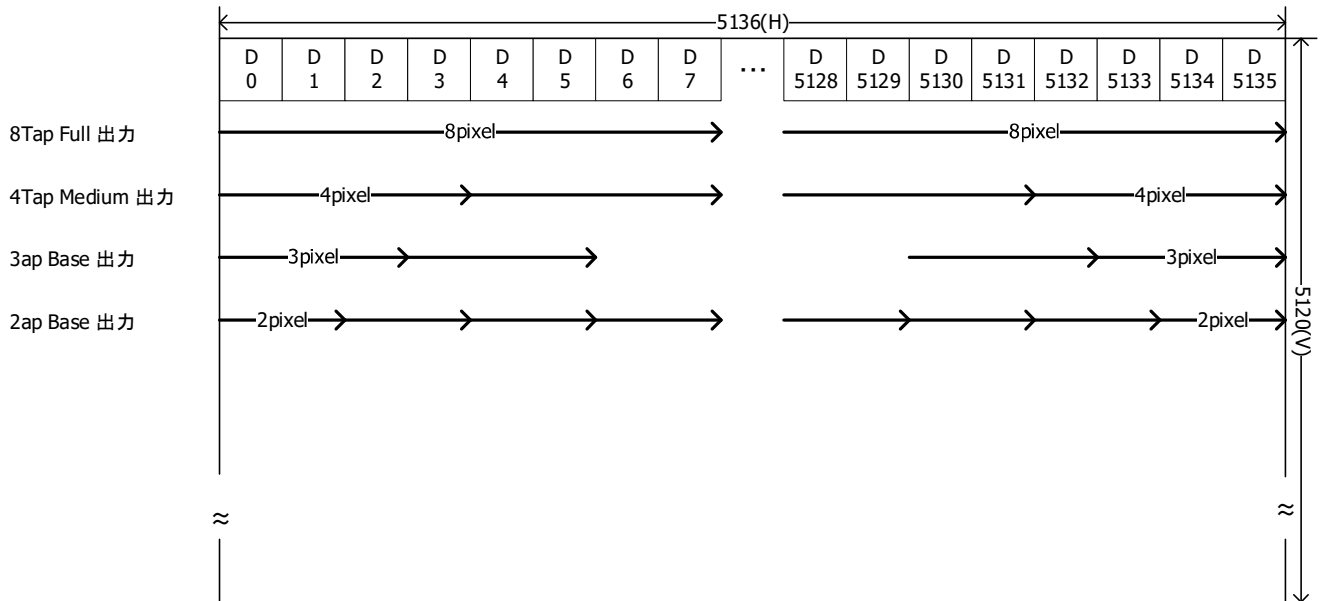

(2) Color

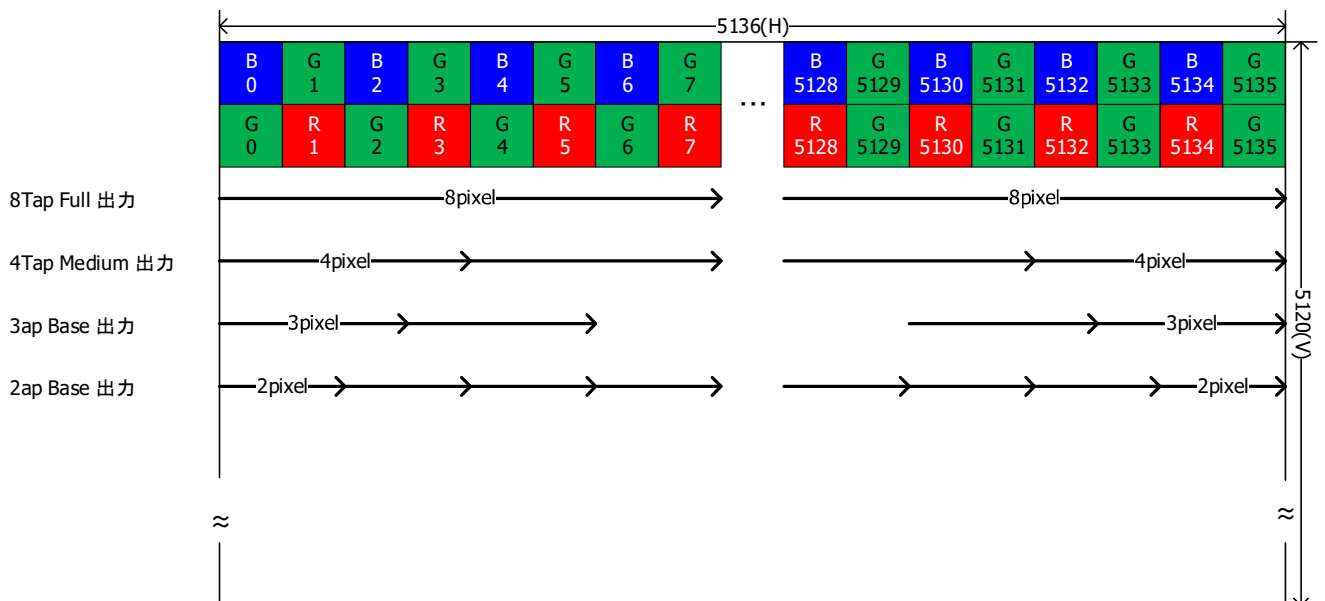

5.10. Fixed Trigger Shutter Mode

- This is the mode to start exposure with external input trigger signals, and set the exposure time with serial commands.
- Delay time (Exposure Time Delay) from detecting trigger edge in the camera to starting exposure.
- Triggers can be accepted even when outputting video signals.
However, trigger signals for exposure to start the next video output prior to the completion of video transmission for the prior video output signals can not be accepted.
- Trigger input during exposure time should be ignored. (Refer to the below A)
- The delay time is fixed with the Trigger Hsync Mode ON.
However, if you use inputting the trigger signals for exposure to start the next video output prior , the line noise appears occasionally by the trigger timing.

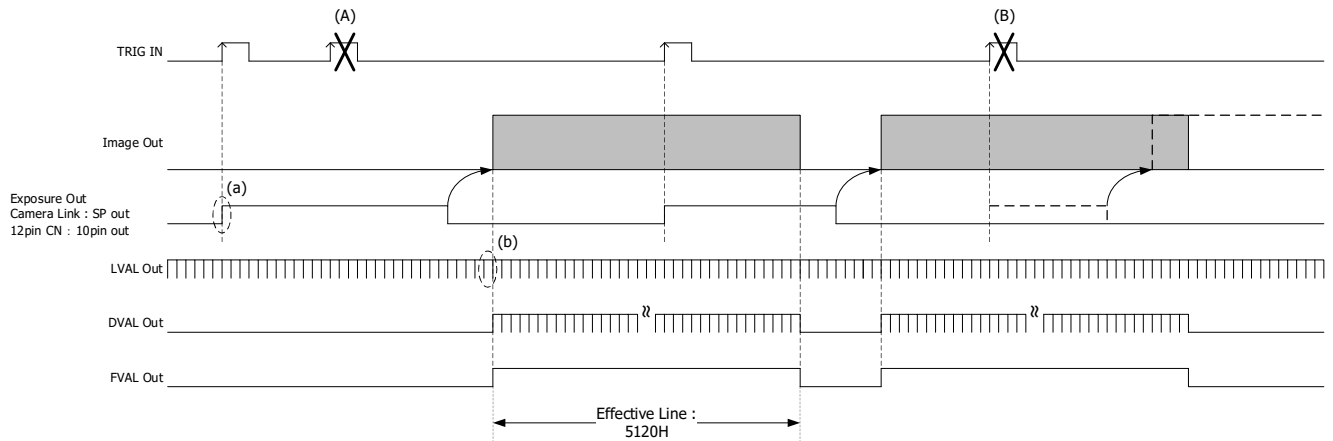

Trigger Hsync mode : (Address:17h)	OFF(Data:0)	ON(Data:1) [Factory setting]
Exposure Time Delay (a)	Exposure Delay 0 	Exposure Delay max1HD 2Tap : max 34.207us 3Tap : max 25.655us 4Tap : max 17.103us 8Tap : max 8.552us
LVAL signal before rising of FVAL (b)	 The length of LVAL of point (b) is variable.	 LVAL length is always fixed.

5.11. Pulse Width Trigger Shutter Mode

- This is the mode to start exposure with external input trigger signals, and set the exposure time with pulse width of the trigger signals.
- Delay time (Exposure Time Delay) from detecting trigger edge in the camera to starting exposure, and from detecting trigger end edge to completing exposure.
- Pulse width is min. 2HD (min) to approx. 2 frames.

Functionally, there is no upper limitation, but noises such as dark noises and shadings may be noticeable at long time exposure.

- Triggers can be accepted even when outputting video signals.

However, trigger signals for exposure to start the next video output prior to the completion of video transmission for the prior video output signals can not be accepted.

- The delay time is fixed with the Trigger Hsync Mode ON.

However, if you use inputting the trigger signals for exposure to start the next video output prior , the line noise appears occasionally by the trigger timing.

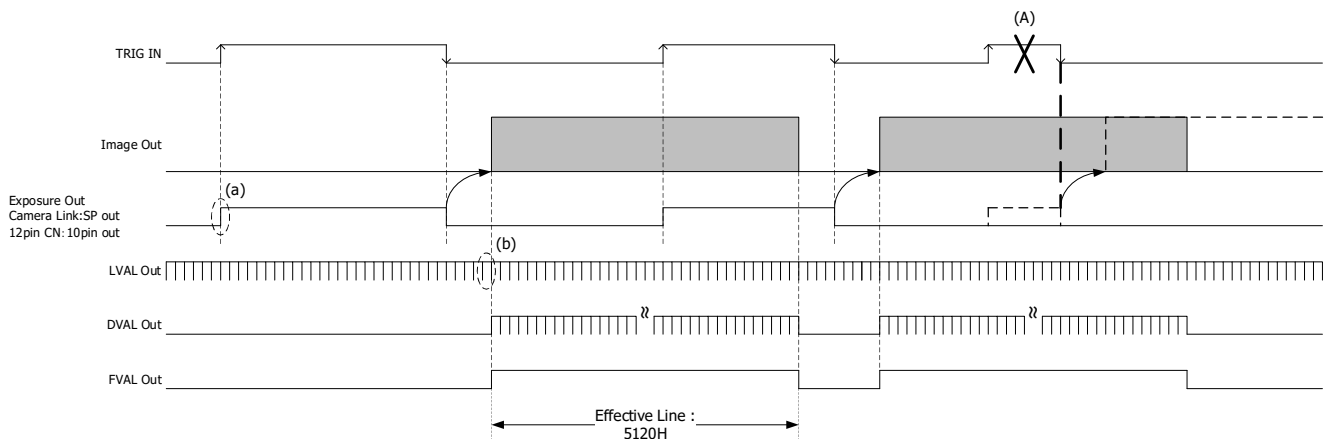

Trigger Hsync mode : (Address:17h)	OFF(Data:0)	ON(Data:1) [Factory setting]
Exposure Time Delay (a)	Exposure Delay 0 	Exposure Delay max1HD 2Tap : max 34.207us 3Tap : max 25.655us 4Tap : max 17.103us 8Tap : max 8.552us
LVAL signal before rising of FVAL (b)	 The length of LVAL of point (b) is variable.	 LVAL length is always fixed.

6. Partial Scan Mode

- 1 partial area can be set by serial commands.

Function	Address(Hex)	Data(Hex)
Partial scan mode ON/OFF	08	Full frame scan mode (00h)
		Partial scan mode (01h)
Partial scan Start position	40-41	mono min:0(0000h) ~ max:5119(13FFh)
		color min:0(0000h) ~ max:5118(13FEh)
Partial scan Effective line	50-51	mono min:1(0001h) ~ max:5120(1400h)
		color min:2(0002h) ~ max:5120(1400h)

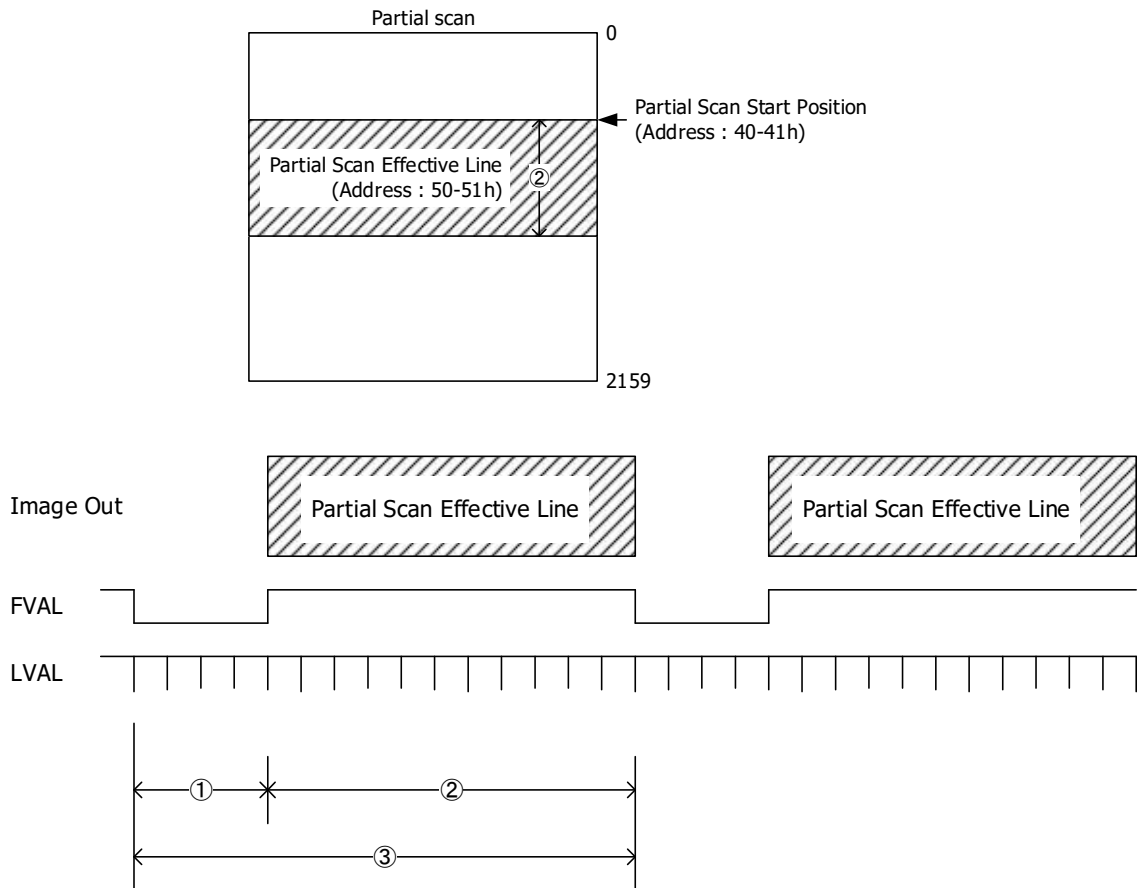

(Example : Effective line :20 lines)

- ① : 64 lines fixed
- ② : Partial Area : 20 lines
- ③ : Total frame line : 84 lines

- Total number of frames = Number of V blanking lines (fixed to 64H) + Number of partially valid lines
(Partial scan start position + number of partial valid lines) <= 5120 must be satisfied.

- Partial scan start position and number of partial effective lines

B&W : n x 1 LINE

Color : n x 2 LINE

- Frame rate = 1 / (Entire frame line numbers × Time for 1 line)

Time for 1 line

Camera mode	Time for 1 line
2Tap Base Configuration	34.207us
3Tap Base Configuration	25.655us
4Tap Medium Configuration	17.103us
8Tap Full Configuration	8.552us

- Example

	Effective line(H)	Total line(H)	Frame rate(fps)			
			8Tap Full	4ap Medium	3Tap Base	2Tap Base
mono(min)	1	65	1798.9	899.5	599.7	449.8
color(min)	2	66	1771.7	885.9	590.6	442.9
.
VGA相当	480	544	214.9	107.5	71.7	53.7
.
XGA相当	768	832	140.5	70.3	46.8	35.1
.
SXGA相当	1024	1088	107.5	53.7	35.8	26.9
.
UXGA相当	1200	1264	92.5	46.3	30.8	23.1
.
OFF(max)	5120	5184	22.6	11.3	7.5	5.6

Horizontal cutout function

It is possible to cut out the left and right in the horizontal direction with 24 pixels x n. The frame rate does not change even if you cut out the horizontal direction.

Function	Address(Hex)	Data(Hex)
Horizontal cut-out	16	min: 0(00h) ~ max: 106(6Ah) L/R Cut size(pixel) = setting value x 24pixel
		min: 0= Full 1=L/R 24pixel cut max: 106 = L/R 2544pixel cut

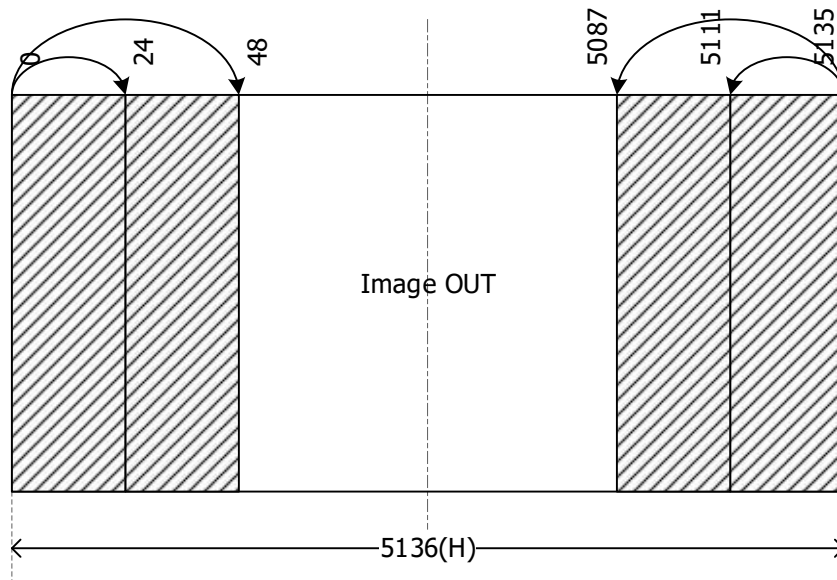

7. Remote Communication

Via camera link cable, the camera can be controlled.

Communication Settings	
Baud Rate	: 115200bps (fixed)
Data	: 8bit
Stop bit	: 1bit
Parity	: None
XON / XOFF	: No Control

- Send Command Format (Host to Camera)

If send a command, set the command and parameter between STX and ETX.

STX (02H)	command (2byte)	parameter (ASCII code) (20H-7FH)	ETX (03H)
--------------	--------------------	-------------------------------------	--------------

- Return Command Format (Camera to Host)

Normally, a camera returns a control code which is ACK or NAK.

If return value has a text message, the message is between STX and ETX.

ACK (06H)	... Succeed
--------------	-------------

NAK (15H)	... Fail
--------------	----------

STX (02H)	command (2byte)	parameter (ASCII code) (2FH- 7FH)	ETX (03H)	... return message
--------------	--------------------	--------------------------------------	--------------	--------------------

- Command List

Command	Function
SR	Set some values of resister
GR	Get some values of resister
SU	Set a user's data
GU	Get a user's data
CS	Save all configurations
CR	Restore all configurations
QM	Get a model name
QS	Get a serial number
QV	Get a firmware version
QE	Get a detail of error information

8.1. Command Specifications

1) Set some values of resister

【Command】 Set : Resister

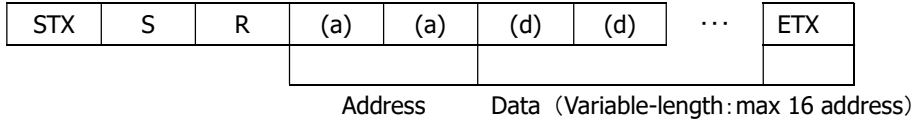

【Return Value】

Succeed	...	ACK
Fail	...	NAK

2) Get some value of resister

【Command】 Get : Resister

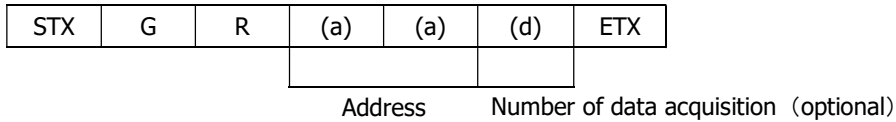

【Return value】

Succeed	...	STX	A	R	(d)	(d)	...	ETX	
Fail	...	NAK							

Data (Data length depends on the number of acquisitions)

【Remarks】

The command gets some value of register of the specified address. The number of the acquisition is between '0' and 'F' (Hexadecimal).

If appoint '0' at the address, the command send data of 16 address. If the command is omitted at the address, the command send an address.

3) Set User's data

【Command】 Set : User's data

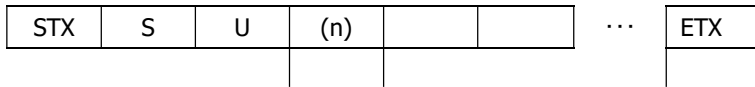

Table No. User's data (fixed length :16byte)
(0~3)

【Return Value】

Succeed	...	ACK
Fail	...	NAK

【Remarks】

The commands, sets free data on the specified register, and can use 4 tables (1 table : 16 characters).

4) Get User's data

【Command】 Get : User's data

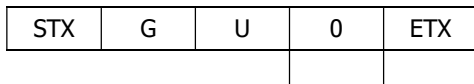

Table No.
(0~3)

【Response】

Succeed	...	STX	A	U	(d)	(d)	...	ETX
---------	-----	-----	---	---	-----	-----	-----	-----

User's data (fixed length : 16byte)

Fail	...	NAK
------	-----	-----

5) Save all configurations

【Command】 Configuration : Save

STX	C	S	ETX
-----	---	---	-----

【Return Value】

Succeed	...	ACK
Fail	...	NAK

6) Restore all configurations

【Command】 Configuration : Restore

STX	C	R	ETX
-----	---	---	-----

【Return Value】

Succeed	...	ACK
Fail	...	NAK

7) Get a model name

【Command】 Query : Model name

STX	Q	M	ETX
-----	---	---	-----

【Return Value】

Succeed	...	STX	R	M	(d)	(d)	...	ETX
					Model name (Fixed length: 16byte)			
Fail	...	NAK						

8) Get a serial number

【Command】 Query : Serial number

STX	Q	S	ETX
-----	---	---	-----

【Return Value】

Succeed	...	STX	R	S	(d)	(d)	...	ETX
					Serial Number(Fixed length: 8byte)			
Fail	...	NAK						

9) Get a firmware version

【Command】 Query : Version

STX	Q	V	ETX
-----	---	---	-----

【Return Value】

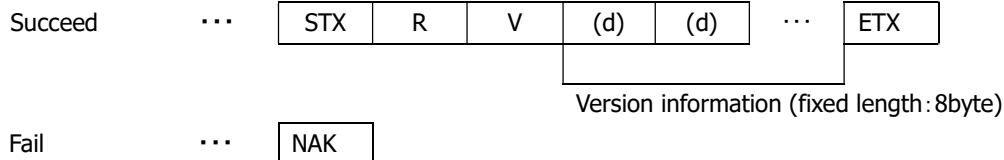

10) Get a detail of error information

【Command】 Query : Error

STX	Q	E	ETX
-----	---	---	-----

【Return Value】

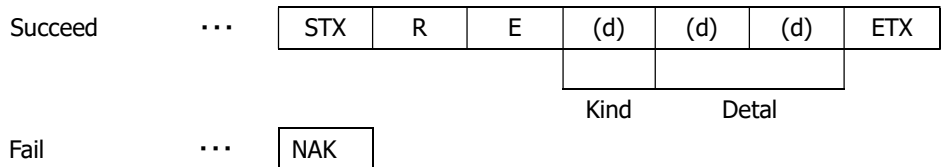

Kind	Detail
0: No Error	00: Normal result
1: Communication Protocol Error	00: The command is undefined.
	01: The command length is more than defined.
	02: The address is undefined.
	03: The value of data is undefined.
	04: The length is more than defined.
	05: The table number is undefined.
	06: The string of user data was abnormal.
2: Internal Control Error	00: Internal control is abnormal.
	01: A read only address was written by the command.
	02: A protected address was written by the command.
	03: Out of range address was written by the command.
	04: The selected table number is abnormal.
	05: The value of the man acquisition area is abnormal.
	06: A function is not implemented.

8.2. Control Example

1) How to check trigger shutter mode. (The command gets a value from address 04)

【Send Command】

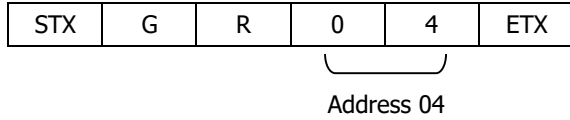

【Return value form camera】

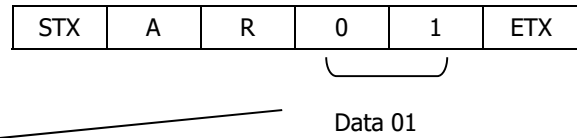

【Receive Return Value】

The camera is working with a trigger shutter mode, because the command received a 01 from the camera.

2) How to check trigger shutter mode. (The command gets consecutive 2 bytes values from address 20)

【Send Command】

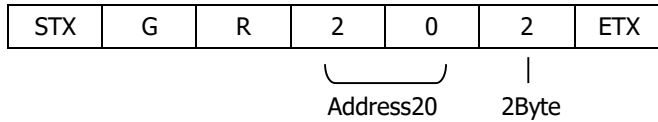

【Receive return value】

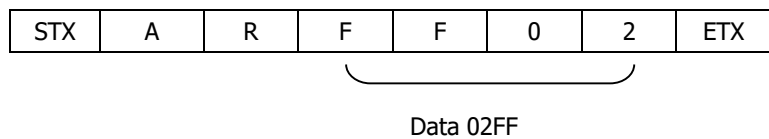

【Receive return value】

The shutter mode of camera is working +12dB, because the command received a 02FF(767) from the camera.

5) How to save configurations of a camera. (The command send CS)

【Send Command】



【Return value form camera】



【Receive Return Value】

The command finished normally, because the command received ACK from the camera.

6) How to restore the camera to initial settings. (The command send CR)

【Send Command】

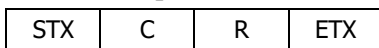

【Return value form camera】



【Receive Return Value】

The command finished normally, because the command received ACK from the camera.

7) How to get detail of a communication error.

【Send Command】

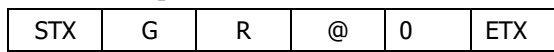

Set the address invalid value



【Return value form camera】



【Receive return value】

The command finished abnormally, because the command received 'NAK' from the camera.

When the command did not finish normally, retry to send command or send to get detail of a detail error command.

【Send Command】

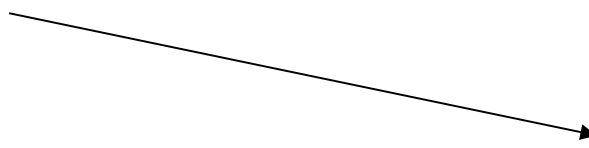
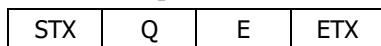

【Return value form camera】

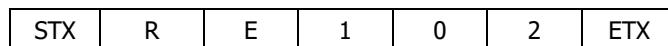

Kind1 Detail 02



【Receive Return Value】

The 'GR' command accessed invalid address , because the error command received kind '1' and detail '02'.

8. Function Setting

Function	Address(Hex)	Data(Hex)				
			2Tap Base	3Tap Base	4Tap Medium	8Tap Full
Preset shutter	01	00:	1/6s	1/8s	1/12s	1/23s
		01:	1/9s	1/10s	1/15s	1/30s
		02:	1/12s	1/15s	1/25s	1/50s
		03:	1/25s	1/30s	1/50s	1/100s
		04:	1/50s	1/60s	1/100s	1/200s
		05:	1/100s	1/150s	1/200s	1/400s
		06:	1/200s	1/300s	1/400s	1/750s
		07:	1/400s	1/500s	1/750s	1/1,500s
		08:	1/750s	1/1,000s	1/1,500s	1/3,000s
		09:	1/1,500s	1/2,000s	1/3,000s	1/5,000s
		0A:	1/3,000s	1/4,000s	1/5,000s	1/10,000s
		0B:	1/5,000s	1/7,000s	1/10,000s	1/17,000s
		0C:	1/9,000s	1/10,000s	1/15,000s	1/25,000s
		0D:	1/12,000s	1/15,000s	1/20,000s	1/32,000s
		0E:	1/20,000s	1/25,000s	1/32,000s	1/43,000s
				0F:	Manual shutter (Address 24-25h)	
Preset white balance (color)	02	00:	THRU			
		01:	3200K(IRcut filter C5000)			
		02:	THRU(Spare)			
		03:	Manual			
Trigger shutter mode	04	00:	Normal (Trigger OFF)			
		01:	Fixed trigger shutter mode (Address01)			
		02:	Pulse width trigger shutter mode			
Trigger polarity	05	00:	Positive			
		01:	Negative			
Trigger input	06	00:	CC1			
		01:	12pin connector 11pin-input			
Partial scan mode ON/OFF	08	00:	Full frame			
		01:	Partial scan			
Gamma ON/OFF	09	00:	OFF($\gamma = 1.0$)			
		01:	ON($\gamma = 0.45$)			

Function	Address(Hex)	Data(Hex)	
Camera output mode	0A	00:	8Tap Full Configuration
		01:	4Tap Medium Configuration
		02:	2ap Base Configuration
		03:	3ap Base Configuration
Output bit	0B	00:	8bit 8Tap, 4Tap, 3Tap, 2Tap Configuration
		01:	10bit 8Tap, 4Tap, 2Tap Configuration
		02:	12bit 4Tap, 2Tap Configuration
Horizontal cutout	16	LL:	min:0(00h) ~ max:106(6Ah) L/R Cut size(pixel) = setting value x 24pixel
			min:0=Full 1=L/R 24pixel cut max:106 = L/R 2544pixel cut
Trigger Hsync mode	17	00:	OFF
		01:	ON
Flip upside down	18	00:	Normal
		01:	Flip upside down
LED ON/OFF	1B	00:	OFF
		01:	ON
Set-up	1F	LL:	min:0(00h) ~ max255(FFh)
Manual gain	20-21	LLHH:	min:0(0000h) ~ max:767(02FFh) x1.0(0dB) ~ x4.0(+12dB) Gain = (setting value+256) / 256
			0(0000H) : x1.0(0dB)
			256(0100H) : x2.0(+6dB) 767(02FFH) : x4.0(+12dB)
Manual shutter	24-25	LLHH:	min:0(0000h) ~ max:2159(086Fh)
			2Tap Base Configuration : Shutter time = 14.621us + (5120 - (setting value)) x 34.207us min:0=175.2ms, max:5119=48.8us
			3Tap Base Configuration : Shutter time = 14.621us + (5120 - (setting value)) x 25.655us min:0=131.4ms, max:5119=40.3us
			4Tap Medium Configuration : Shutter time = 14.621us + (5120 - (setting value)) x 17.103us min:0=87.6ms, max:5119=31.7us
			8Tap Full Configuration : Shutter time = 14.621us + (5120 - (setting value)) x 8.552us min:0=43.8ms, max:5119=23.2us

Function	Address(Hex)	Data(Hex)	
Manual white balance R (color)	28-29	LLHH:	min:0(0h) ~ max:767(02FFh) x1.0(0dB) ~ x4.0(+12dB) Gain = (setting value+256) / 256
Manual white balance B (color)	2A-2B		0(0000H) : x1.0(0dB) 256(0100H) : x2.0(+6dB)
Manual white balance G (color)	2C-2D		767(02FFH) : x4.0(+12dB)
Partial scan start position	40-41	LLHH:	mono min:0(0000h) ~ max:5119(0FFFh)
			color min:0(0000h) ~ max:5118(0FFEh)
Partial scan effective line	50-51	LLHH:	mono min:1(0001h) ~ max:5120(1000h)
			color min:2(0002h) ~ max:5120(1000h)

※ LLHH : The data set with 2 Byte shall be set with Low Byte first, then set with High Byte.

< Example > Manual Shutter (Address 24-25h) ->6671(1A0FH)

STX SR 24 0F 1A ETX

9. Dimensions

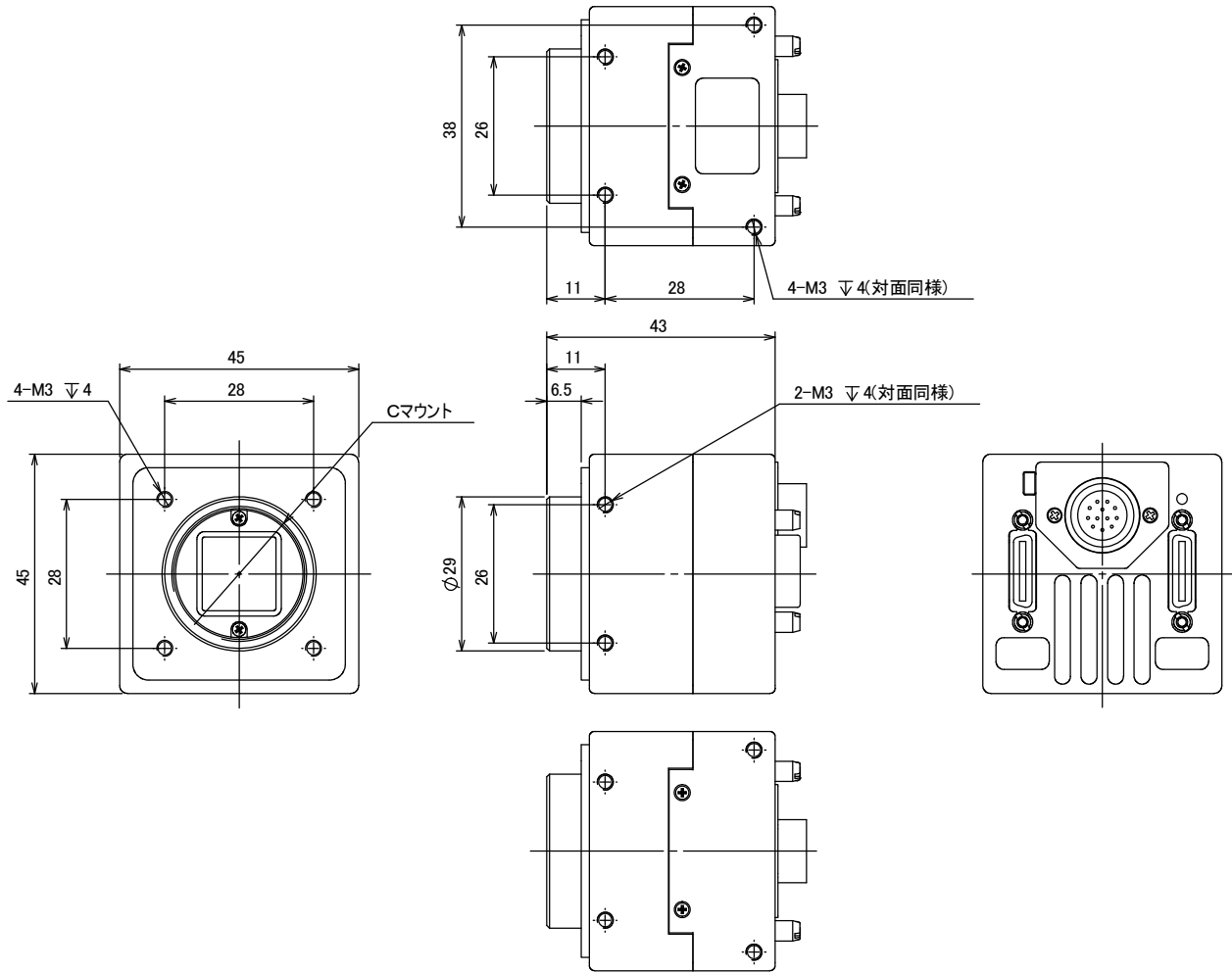

10. Initial Setting

Function	Address	Data	
Preset shutter	01	00:	OFF(1/22.6s)
Preset white balance (Color)	02	01:	3200K
Trigger shutter mode	04	00:	Normal (Trigger OFF)
Trigger polarity	05	00:	Positive
Trigger input	06	00:	CC1
Partial scan	08	00:	Full frame scan mode
Output mode	0A	00:	8Tap Full Configuration
Output bit	0B	00:	8bit
Horizontal cutout	16	00:	0
Trigger Hsync mode	17	01:	ON
Image flip	18	00:	Normal
LED ON/OFF	1B	01:	ON
Set-up	1F	0E:	Set-up
Manual gain	20-21	0000:	x1(0dB)
Manual shutter	24-25	0000:	OFF(1/22.6s)
Manual white balance R (Color)	28-29	0000:	x1.0(0dB)
Manual white balance B (Color)	2A-2B	0000:	x1.0(0dB)
Manual white balance G (Color)	2C-2D	0000:	x1.0(0dB)
Partial scan Start position	40-41	0000:	Start position 0
Partial scan Effective line	50-51	0B20:	Effective line 5120

11. Cases for Indemnity (Limited Warranty)

We shall be exempted from taking responsibility and held harmless for damage or losses incurred by the user in the following cases.

- In case damage or losses are caused by fire, earthquake, or other acts of God, acts by third party, deliberate or accidental misuse by the user, or use under extreme operating conditions.
- In case indirect, additional, consequential damages (loss of business interests, suspension of business activities) are incurred as result of malfunction or non-function of the equipment, we shall be exempted from responsibility for such damages.
- In case damage or losses are caused by failure to observe the information contained in the instructions in this product specification & operation manual.
- In case damage or losses are caused by use contrary to the instructions in this product specification & operation manual.
- In case damage or losses are caused by malfunction or other problems resulting from use of equipment or software that is not specified.
- In case damage or losses are caused by repair or modification conducted by the customer or any unauthorized third party (such as an unauthorized service representative).

12. CMOS Pixel Defect

IDULE compensates the noticeable CMOS pixel defects found at the shipping inspection prior to our shipment. On very rare occasions, however, CMOS pixel defects might be noted with time of usage of the products.

Cause of the CMOS pixel defects is the characteristic phenomenon of CMOS itself and IDULE is exempted from taking any responsibilities for them. Should you have any questions on CMOS pixel defects compensation, please contact us.

13. Product Support

When defects or malfunction of our products occur, and if you would like us to investigate on the cause and repair, please contact your distributors you purchased from to consult and coordinate.
