

65M CMOS Camera

ID65MB-CL (B/W)

ID65MC-CL (Color)

Technical Manual

Table of Contents

	PAGE
1. Product Outline	3
2. Handling Precautions	3
3. Specification	4
3.1. General Specification.....	4
3.2. Camera Output Signal Specification	5
3.3. Spectral Response (Representative Value).....	6
4. Connector	7
4.1. Camera Link Connector 12226-1100-00PL (SUMITOMO 3M).....	7
4.2. Power LED	8
4.3. 12pin Connector HR10A-10R-12PB (HIROSE) (CN1)	8
4.4. Power input to camera	8
5. Timing Chart	9
5.1. Horizontal Synchronous Signals Timing (2Tap Base Configuration : 2.4fps).....	9
5.2. Vertical Synchronous Signals Timing (2Tap Base Configuration : 2.4fps).....	9
5.3. Horizontal Synchronous Signals Timing (3Tap Base Configuration : 3.1fps).....	10
5.4. Vertical Synchronous Signals Timing (3Tap Base Configuration : 3.1fps).....	10
5.5. Horizontal Synchronous Signals Timing (4Tap Medium Configuration : 4.7fps).....	11
5.6. Vertical Synchronous Signals Timing (4Tap Medium Configuration : 4.7fps).....	11
5.7. Horizontal Synchronous Signals Timing (8Tap Full Configuration : 9.4fps).....	12
5.8. Vertical Synchronous Signals Timing (8Tap Full Configuration : 9.4fps).....	12
5.9. Image output format.....	13
5.10. Fixed Trigger Shutter Mode	15
6. Partial Scan Mode	17
7. Horizontal cutout function	19
8. Remote Communication	20
8.1. Command Specifications.....	21
8.2. Control Example	25
9. Function Setting	29
10. Dimensions	31
11. Initial Setting	32
12. Cases for Indemnity (Limited Warranty)	33
13. CMOS Pixel Defect	33
14. Product Support	33

1. Product Outline

ID65MB-CL/ID65MC-CL is a Camera Link interfaced and 65M resolution camera module. 65M pixels CMOS sensor with diagonal length 37.361mm is utilized. Entire pixels can be read out within 1/9.4s at Full Configuration output.

Features

- Global Shutter CMOS sensor is utilized.
- Camera Link Base , Medium, Full Configuration are supported.
- Fixed trigger shutter mode, pulse width trigger shutter mode are operable.
- Full frame rates are as follows.

2Tap Base Configuration	2.4fps	8bit/10bit/12bit
3Tap Base Configuration	3.1fps	8bit
4Tap Medium Configuration	4.7fps	8bit/10bit/12bit
8Tap Full Configuration*	9.4fps	8bit/10bit

*Initial Setting : 8Tap Full Configuration (9.4fps, 8bit)

2. Handling Precautions

The camera must not be used for any nuclear equipment or aerospace equipment with which mechanical failure or malfunction could result in serious bodily injury or loss of human life. Our warranty does not apply to damages or defects caused by irregular and /or abnormal use of the product.

Please observe all warnings and cautions stated below.

Our warranty does not apply to damages or malfunctions caused by neglecting these precautions.

Do not use or store the camera in the following extreme conditions :

- Extremely dusty or humid places.
 - Extremely hot or cold places (operating temperature -5°C to +45°C).
 - Close to generators of powerful electromagnetic radiation such as radio or TV transmitters.
 - Places subject to fluorescent light reflections.
 - Places subject to unstable (flickering, etc.) lighting conditions.
 - Places subject to strong vibration.
-
- Remove dust or dirt on the surface of the lens with a blower.
 - Do not apply excessive force or static electricity that could damage the camera.
 - Do not shoot direct images that are extremely bright (e.g., light source, sun, etc.), and when camera is not in use, put the lens cap on.
 - Confirm the mutual ground potential carefully and then connect the camera to monitors or computers. AC leaks from the connected devices may cause damages or destroy the camera.
 - Do not apply excessive voltage. (Use only the specified voltage.) Unstable or improper power supply voltage may cause damages or malfunction of the camera.
 - The voltage ripple of camera power DC +12V±10% shall be within ±50mV. Improper power supply voltage may cause noises on the video signals.
 - The rising time of camera power supply voltage shall be less than +10V, Max 60ms. Please avoid noises like chattering when rising.

3. Specification

3.1. General Specification

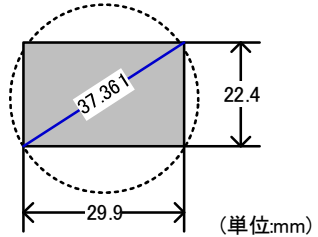
(1) Image Sensor	Device type	Diagonal length 37.361mm, Global Shutter type (GPIXEL GMAX3265)	
	Effective pixel number	9344(H) x 7000(V)	
	Unit cell size	3.2 μ m(H) x 3.2 μ m(V)	
	Image circle	Φ 37.361mm	
			
(2) Video Output Frequency	Pixel Clock	80MHz	
	2Tap Base Configuration	2.4fps	4800(H) x 7056(V) with blanking
	3Tap Base Configuration	3.1fps	3600(H) x 7056(V) with blanking
	4Tap Medium Configuration	4.7fps	2400(H) x 7056(V) with blanking
	8Tap Full Configuration	9.4fps	1200(H) x 7056(V) with blanking
(3) Video Output	2Tap Base Configuration		
	3Tap Base Configuration		
	4Tap Medium Configuration		
	8Tap Full Configuration (Initial Setting)		
(4) Output Format	Sensor AD	12bit	
	Camera Link Output	2Tap Base Configuration :8bit / 10bit / 12bit 3Tap Base Configuration :8bit 4Tap Medium Configuration:8bit / 10bit / 12bit 8Tap Full Configuration :8bit / 10bit	
(5) Sensitivity	B/W	F16	2000lx
	Color	F11	2000lx
(at shutter speed 1/9.4s (OFF), Gain 0dB, Full Configuration mode)			
(6) Power supply input voltage	DC+12V \pm 10% 12 pin connector (Initial Setting) / PoCL		
(7) Power Consumption	max 6.0W (at 8Tap Full Configuration)		
	max 5.8W (at 2Tap/3Tap Base Configuration)		
*When supplying PoCL power in Base Configuration mode, a cable must be connected to the Medium / Full CL connector to supply power.			
(8) Dimensions	H:55mm W:55mm D:45mm excluding projection		
(9) Weight	Approx. 185g		
(10) Lens Mount	M42 P1 mount (Cover glass or IR cut filter in none)		
(11) Optical Axis Accuracy	Refer to drawing for CMOS optical axis accuracy		
(12) Gain Variable Range	0dB ~ +12dB (Guaranteed range)		
(13) Shutter Speed Variable Range	OFF(1/2.4s) ~ 1/12000s (2Tap Base Configuration)		
	OFF(1/3.1s) ~ 1/15000s (3Tap Base Configuration)		
	OFF(1/4.7s) ~ 1/20000s (4Tap Medium Configuration)		
	OFF(1/9.4s) ~ 1/25000s (8Tap Full Configuration)		
(14) Trigger Shutter Mode	Fixed shutter trigger mode / Pulse width shutter trigger mode		
(15) Partial Scan	Mono : Full frame ~ 1Line (1Line/Step) Color : Full frame ~ 2Line (2Line/Step) 1area		
	*Start position and Effective line : Even number only		
(16) Safety/Quality Standards	UL : Conform to UL Standard including materials and others.		
	CE :	To be applied for EN55022:2006 Class A for Emission06 To be applied for EN61000-6-2:2005 for Immunity	
	RoHS : Confirm to RoHS		
(17) Durability	Vibration	20~200 Hz,98m/s ² (10G), X,Y and Z 3directions (120 min for each direction)	
	Shock	No malfunction shall be occurred with 980m/s ² (100G) for \pm X, \pm Y,and \pm Z, 6 directions. (without package)	

(18) Operation Environment	Temperature -5 ~ +45°C Humidity 20 ~ 80%RH with no condensation.
(19) Storage Environment	Temperature -25 ~ +60°C Humidity 20 ~ 80%RH with no condensation.

3.2. Camera Output Signal Specification

(1) Video Output Data	Effective Video Output	9344(H) × 7000(V) *3Tap : 9360(H) × 7000(V) 9360(H) = 9344(H)+16pix(Black)	(at Full Frame Scan Mode)
(2) Sync Signal Output	LVAL FVAL DVAL SP	Camera Link (LVDS)	
	FVAL Exposure	12pin Connector 6pin (LVTTL) 12pin Connector 10pin (LVTTL)	
(3) Camera Control Signal Input	CC2·CC3·CC4	Camera Link (LVDS)	(No Function)
(4) Trigger Input	Polarity	Positive/Negative Selectable	(Address 05h)
	Pulse Width	2HD(Min) ~ (*) 2Tap Base Configuration : 1HD (60us) 3Tap Base Configuration : 1HD (45us) 4Tap Medium Configuration : 1HD (30us) 8Tap Full Configuration : 1HD (15us) *The trigger input signal is sampled n times HD in the camera, and the exposure time is processed n times HD. Trigger pulses shorter than 1 HD are treated as 1 HD wide. Functionally, no upper limitation is set but noises such as dark noises and shadings might be noticeable at long time exposure.	
	CC1 (Trigger Input) 12pin Connector (Trigger Input)	Camera Link (LVDS) 12pin Connector 11pin Input (LVTTL)	(Address 06h)
(5) Serial Communication	SerTC	Camera Link (LVDS)	(Serial to Camera)
	SerTFG		(Serial to Frame Grabber)
(6) Video Signals	White Clip Level	3FFh	(at Gain 0dB, 10bit)
	Setup Level	under 002h	
	Dark Shading	Both horizontal and vertical should be under 00Fh	

3.3. Spectral Response (Representative Value)

ID65MB-CL (B/W)

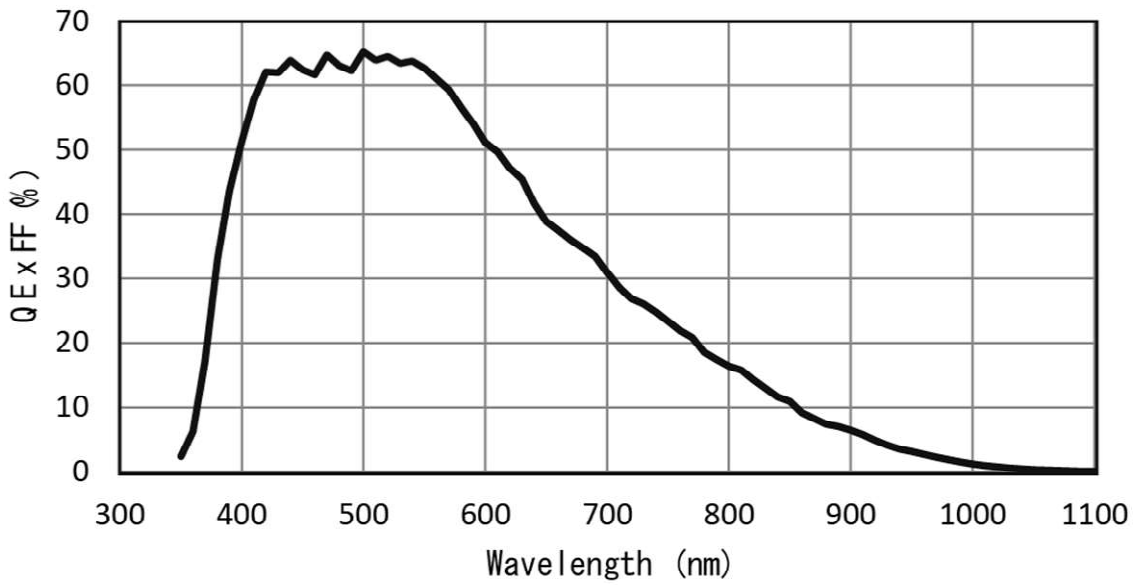

ID65MC-CL (Color)

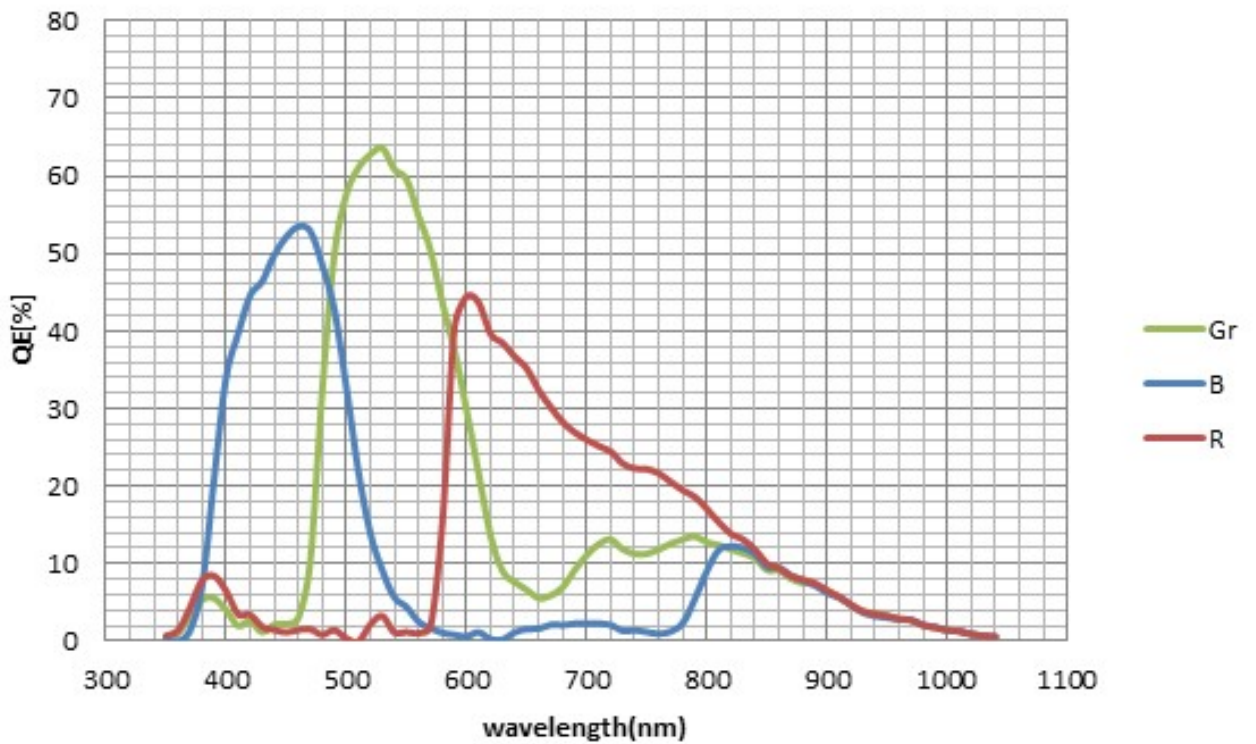

4. Connector

4.1. Camera Link Connector 12226-1100-00PL (SUMITOMO 3M)

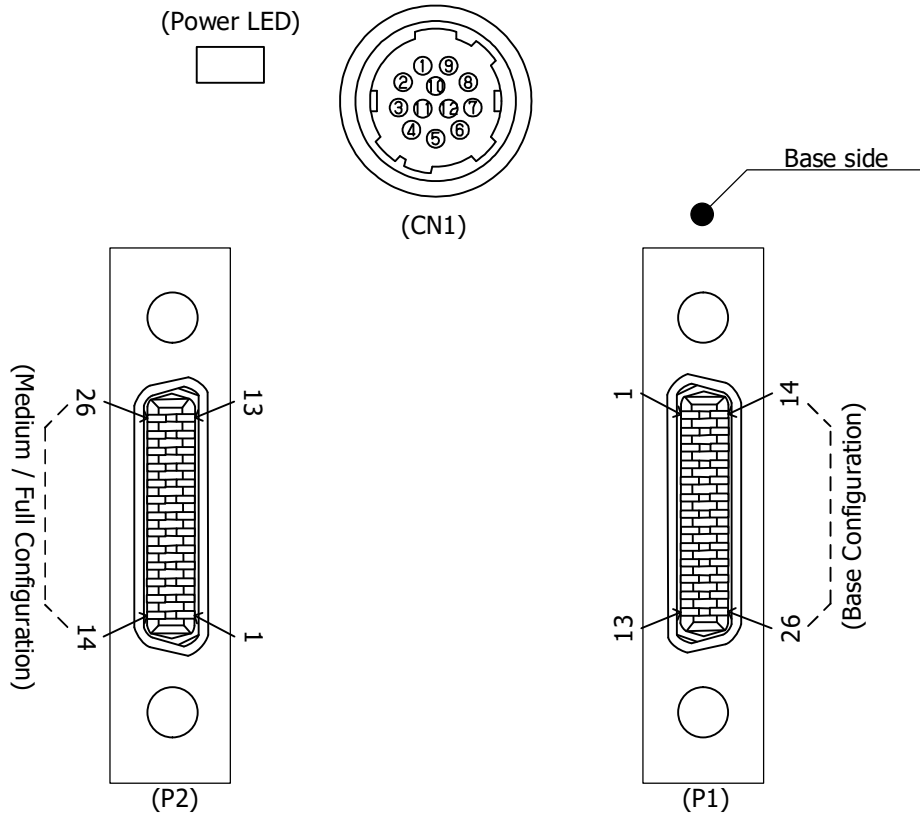

Connector (P2)

PIN No	Name	PIN No	Name
1	+12V(PoCL)	14	GND
2	Y0-	15	Y0+
3	Y1-	16	Y1+
4	Y2-	17	Y2+
5	Yclk-	18	Yclk+
6	Y3-	19	Y3+
7	100Ω	20	Terminated
8	Z0-	21	Z0+
9	Z1-	22	Z1+
10	Z2-	23	Z2+
11	Zclk-	24	Zclk+
12	Z3-	25	Z3+
13	GND	26	+12V(PoCL)

Connector (P1)

PIN No	Name	PIN No	Name
1	+12V(PoCL)	14	GND
2	X0-	15	X0+
3	X1-	16	X1+
4	X2-	17	X2+
5	Xclk-	18	Xclk+
6	X3-	19	X3+
7	SerTC+	20	SerTC-
8	SerTFG-	21	SerTFG+
9	CC1- (Trigger IN -)	22	CC1+ (Trigger IN +)
10	CC2+	23	CC2-
11	CC3-	24	CC3+
12	CC4+	25	CC4-
13	GND	26	+12V(PoCL)

4.2. Power LED

LED lights when the camera is operational. If the power is not supplied or the camera is broken, the LED will not light.
 ※ LED can be turned off (address 1Bh) by serial setting.

4.3. 12pin Connector HR10A-10R-12PB (HIROSE) (CN1)

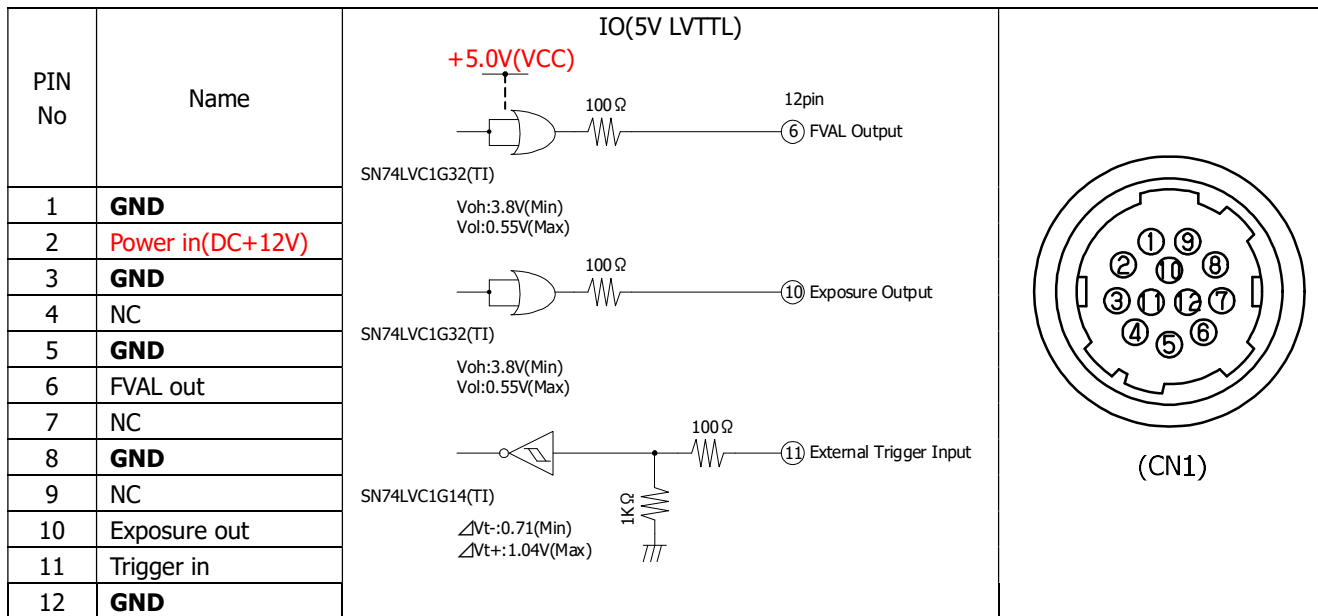

4.4. Power input to camera

Camera rear 12pin connector (2pin) or Camera Link (PoCL) feeding is possible. (Because the power supply is diode-OR connected, there is no problem even if it is powered simultaneously.)

*When supplying PoCL power in Base Configuration mode, a cable must be connected to the Medium / Full CL connector to supply power.

5. Timing Chart

5.1. Horizontal Synchronous Signals Timing (2Tap Base Configuration : 2.4fps)

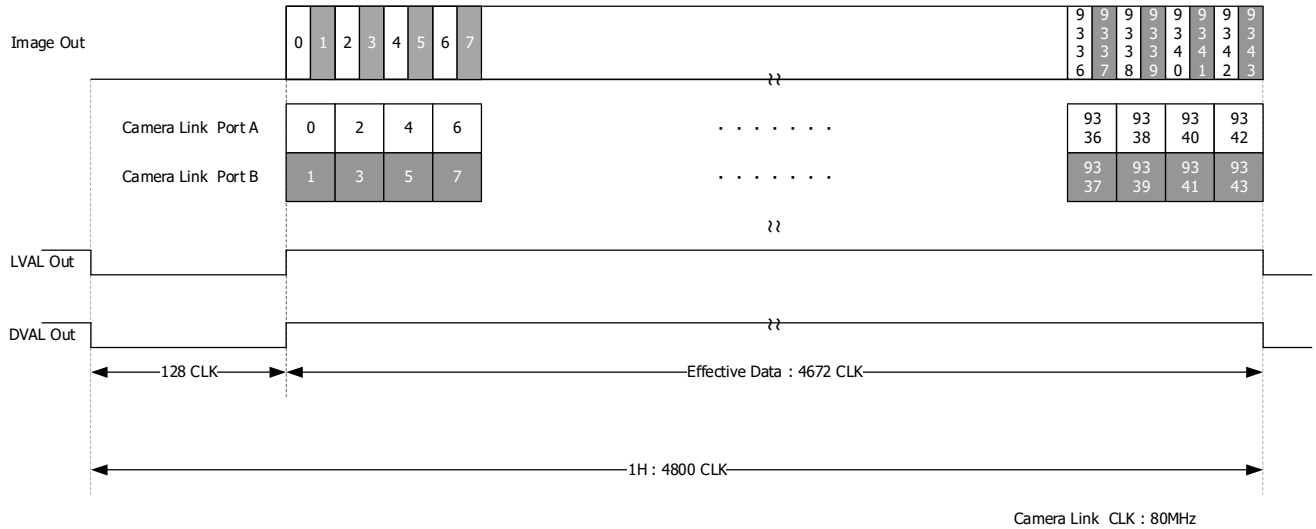

5.2. Vertical Synchronous Signals Timing (2Tap Base Configuration : 2.4fps)

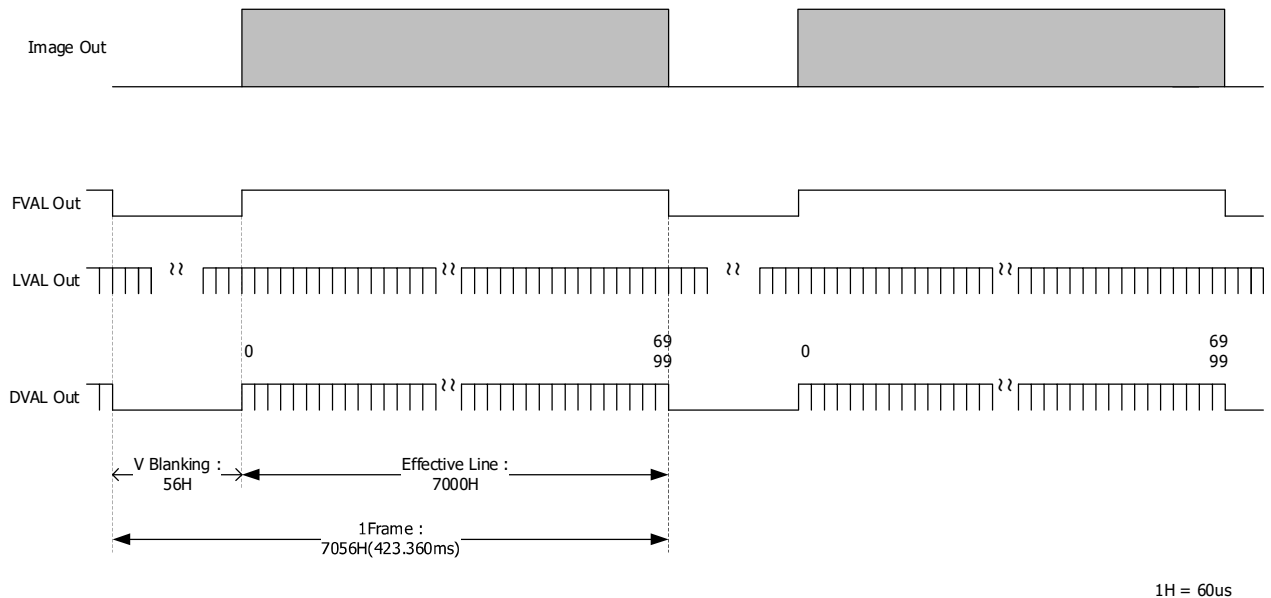

5.3. Horizontal Synchronous Signals Timing (3Tap Base Configuration : 3.1fps)

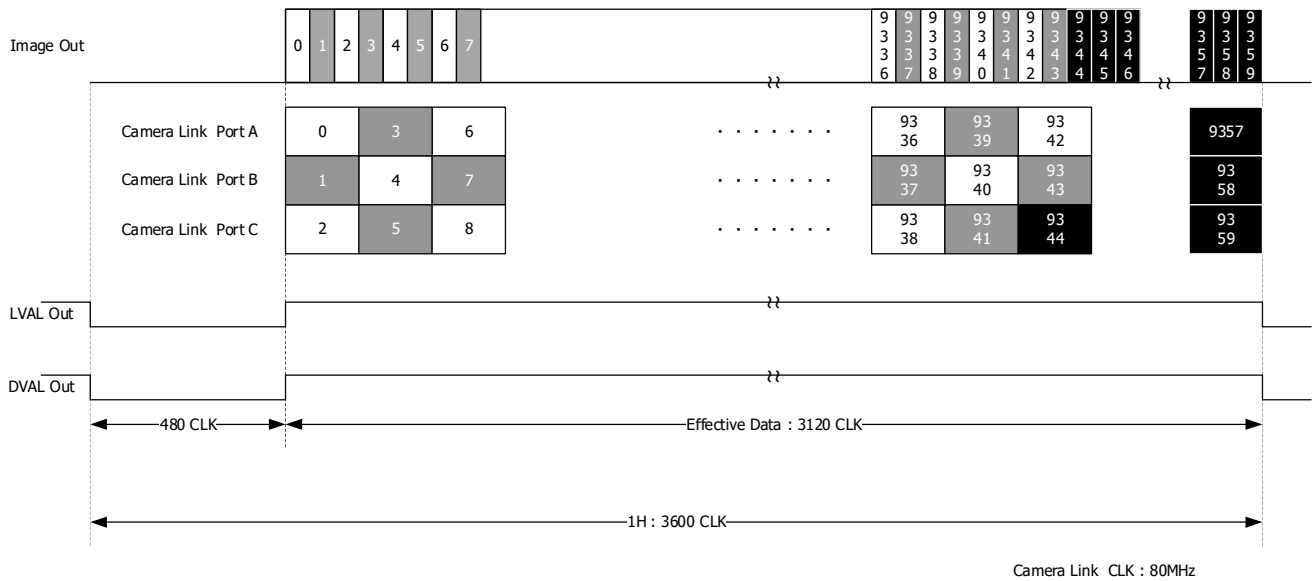

5.4. Vertical Synchronous Signals Timing (3Tap Base Configuration : 3.1fps)

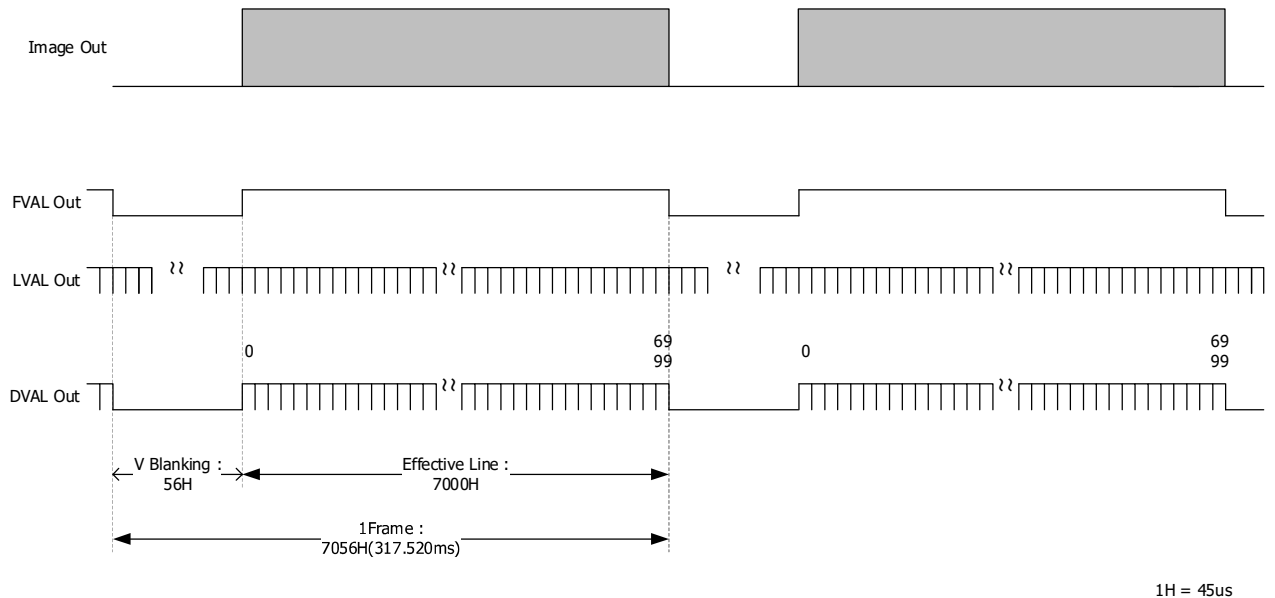

5.5. Horizontal Synchronous Signals Timing (4Tap Medium Configuration : 4.7fps)

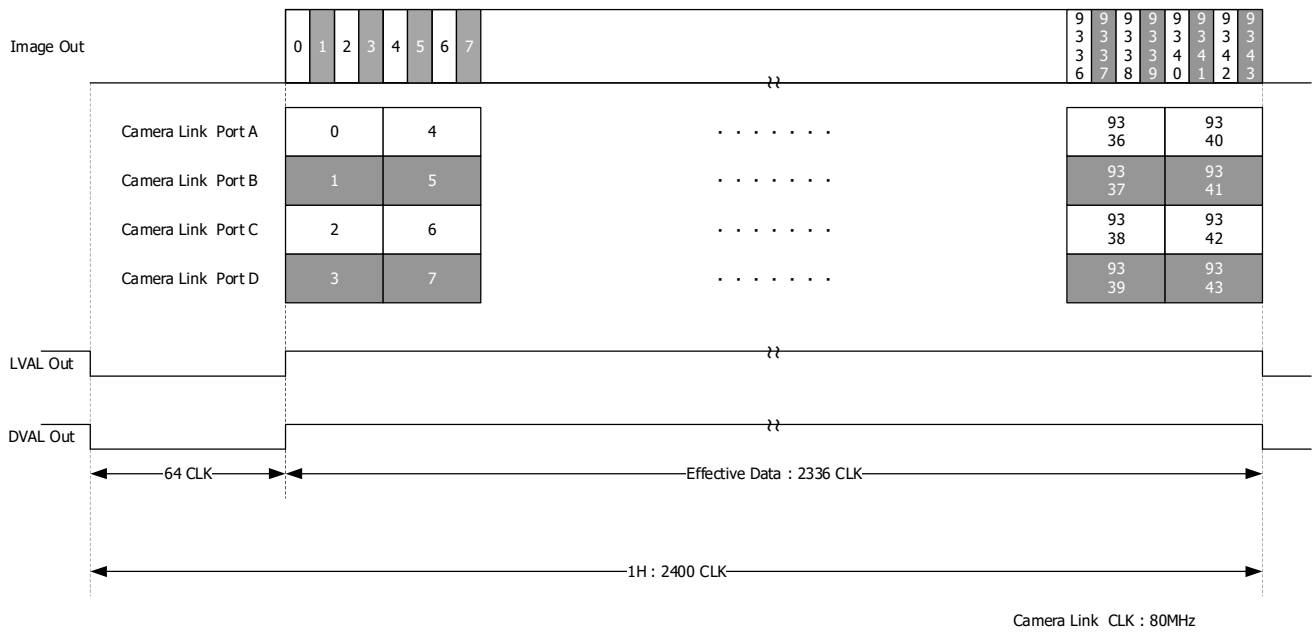

5.6. Vertical Synchronous Signals Timing (4Tap Medium Configuration : 4.7fps)

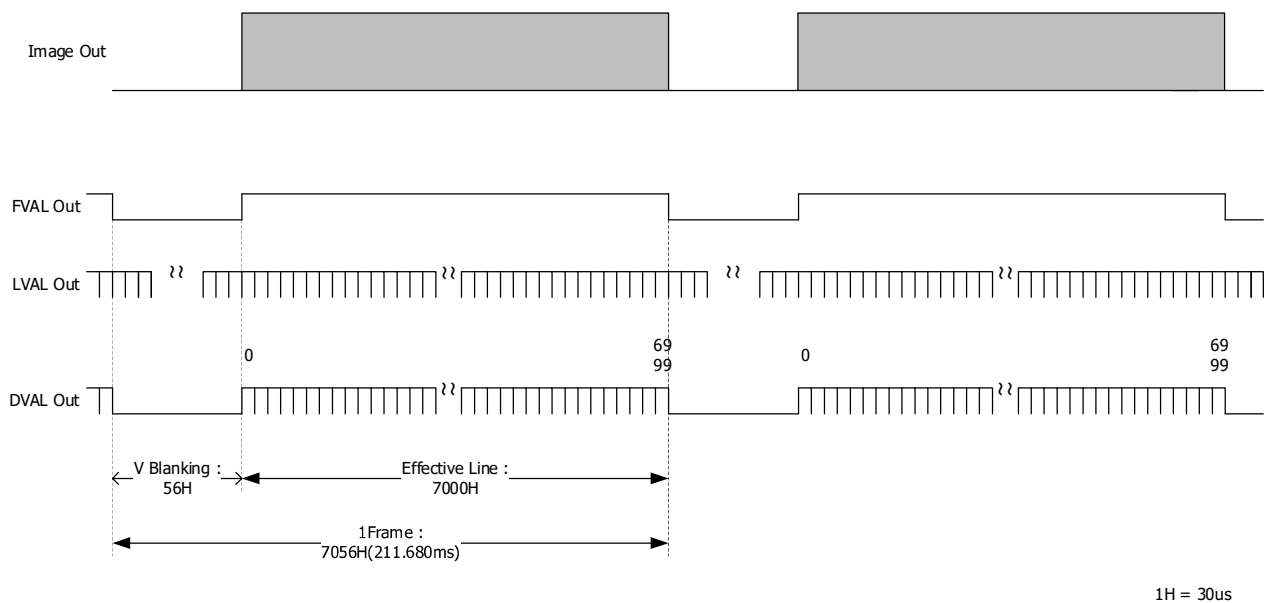

5.7. Horizontal Synchronous Signals Timing (8Tap Full Configuration : 9.4fps)

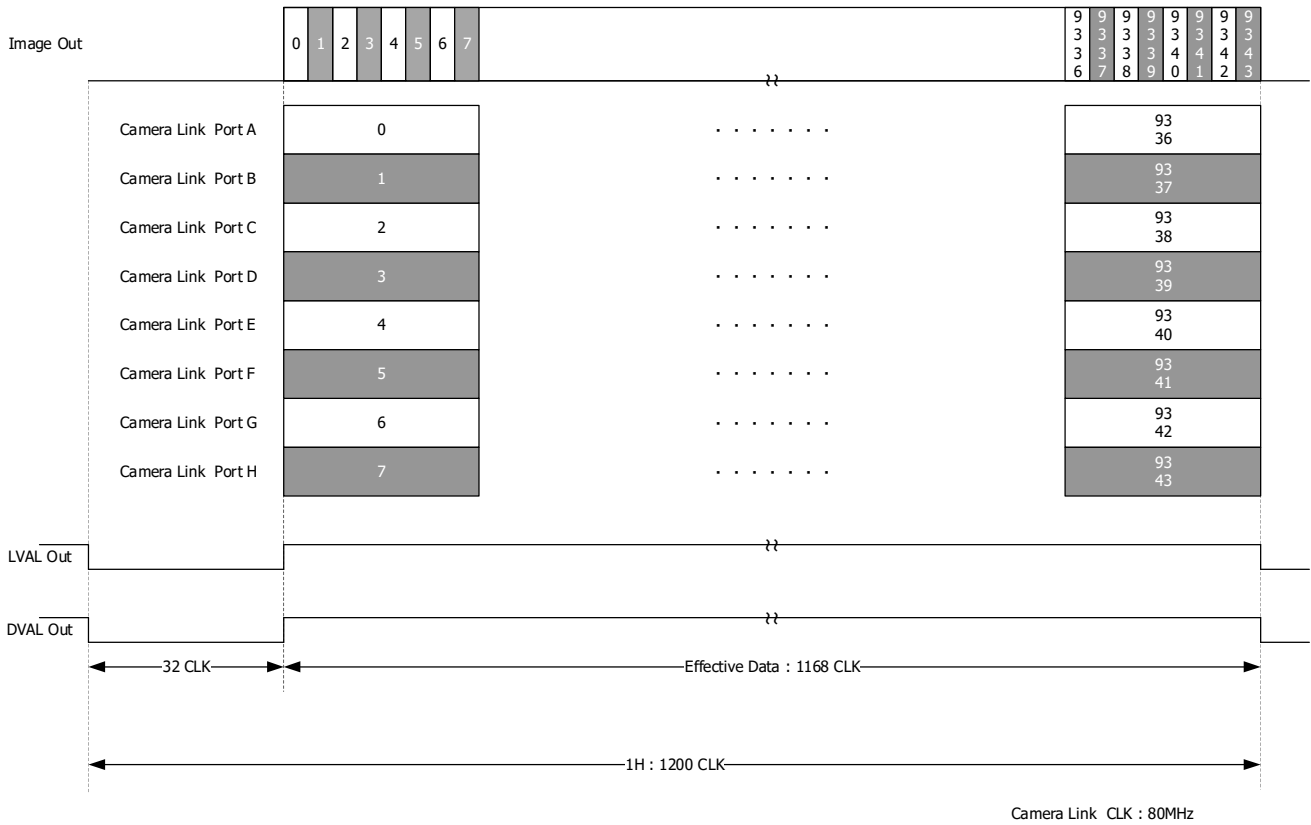

5.8. Vertical Synchronous Signals Timing (8Tap Full Configuration : 9.4fps)

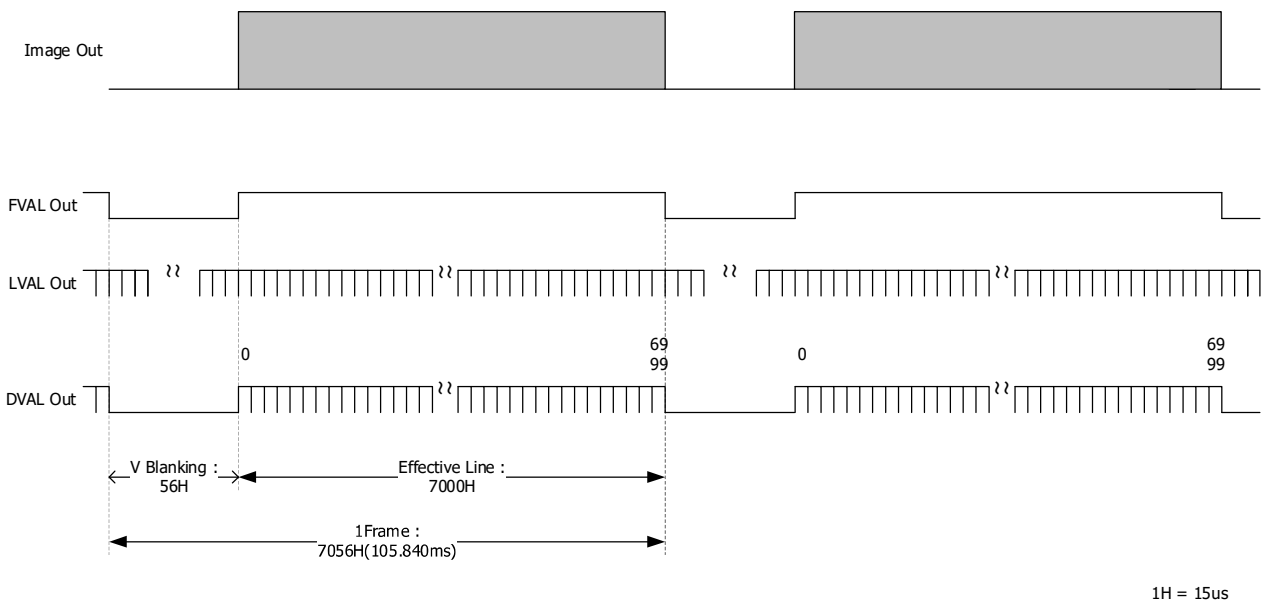

5.9. Image output format

(1) 2Tap Base Configuration : 2.4fps

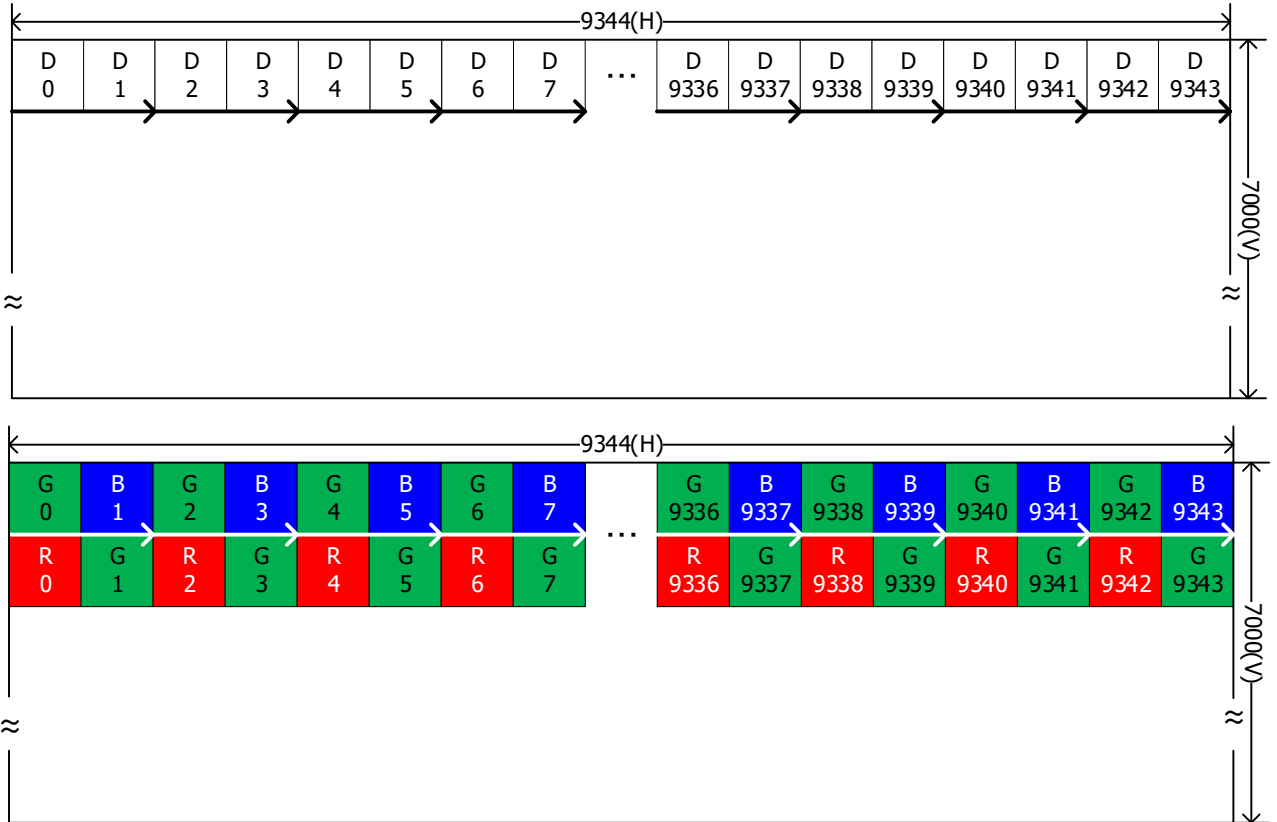

(2) 3Tap Base Configuration : 3.1fps

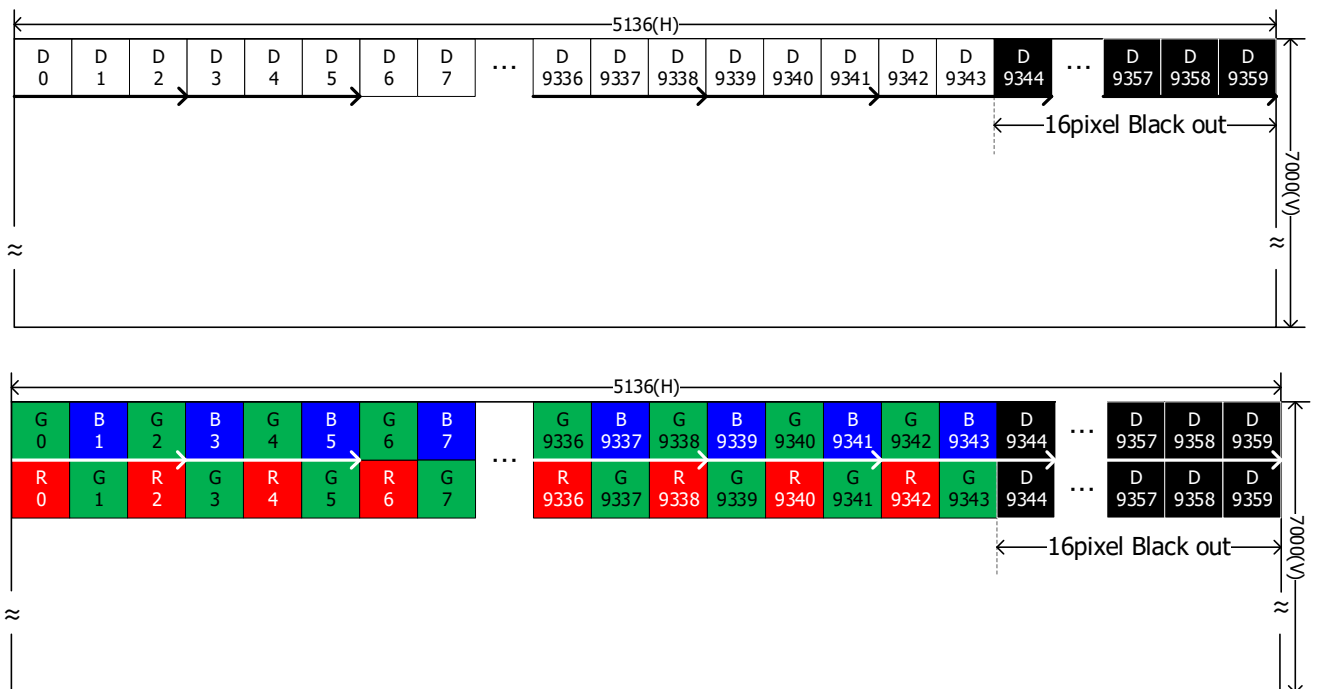

(3) 4Tap Medium Configuration : 4.7fps

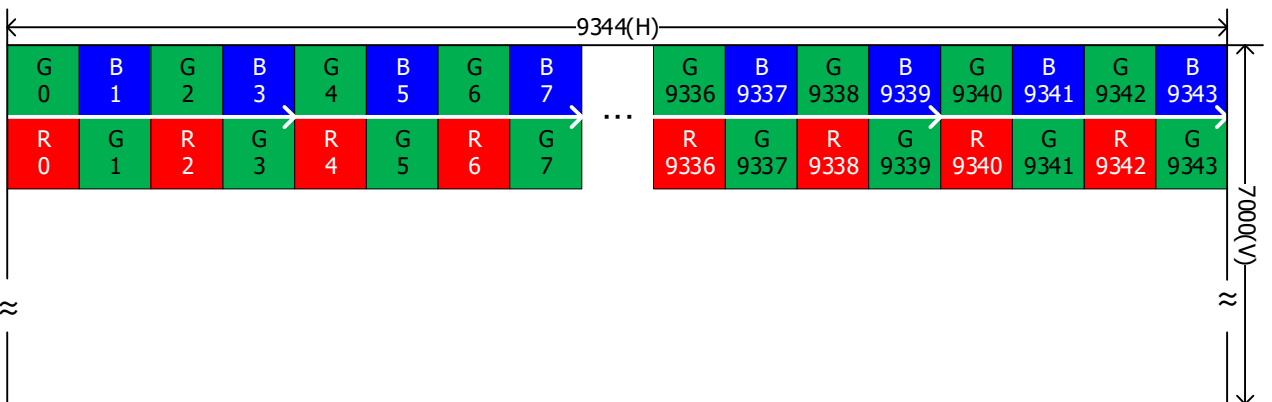
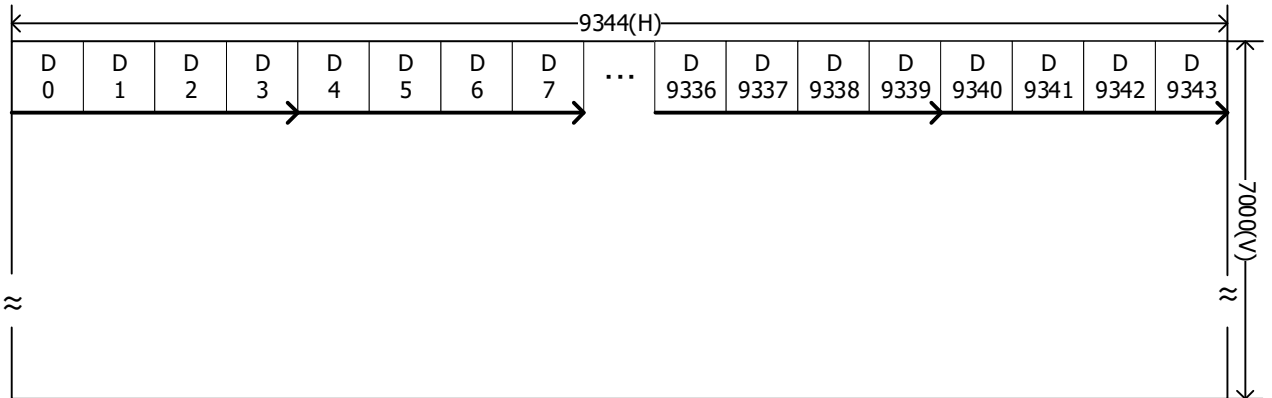

(4) 8Tap Full Configuration : 9.4fps

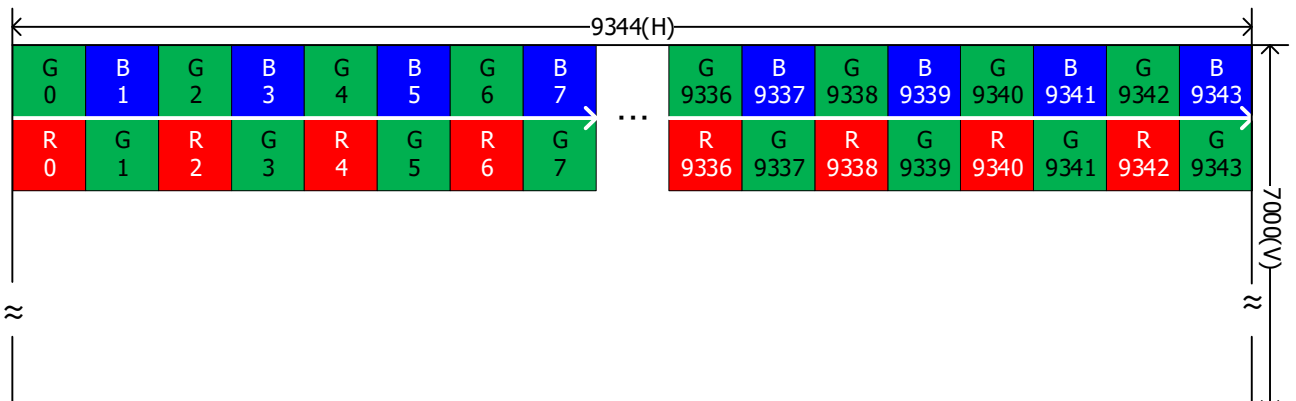
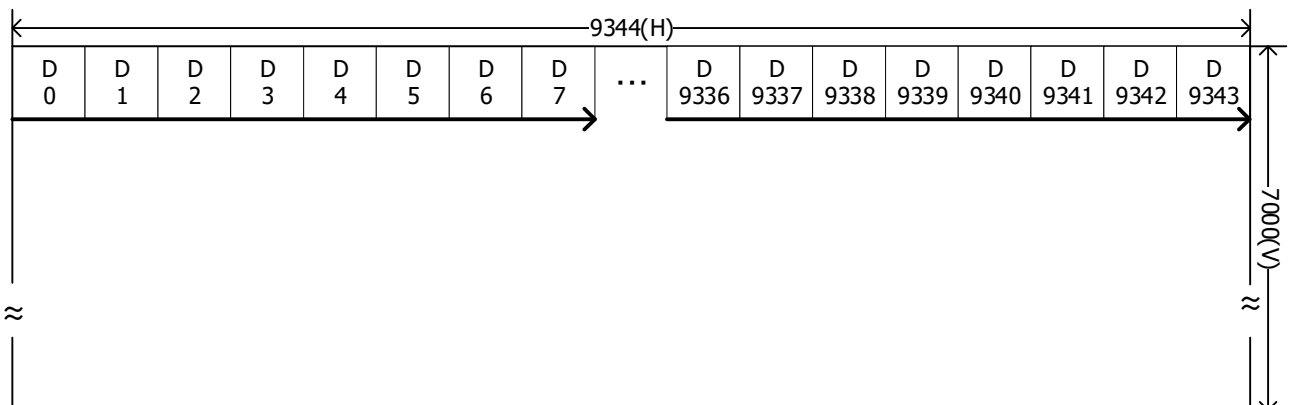

5.10. Fixed Trigger Shutter Mode

- This is the mode to start exposure with external input trigger signals, and set the exposure time with serial commands.
- Delay time (Exposure Time Delay) from detecting trigger edge in the camera to starting exposure.
- Triggers can be accepted even when outputting video signals.
However, trigger signals for exposure to start the next video output prior to the completion of video transmission for the prior video output signals can not be accepted.
- Trigger input during exposure time should be ignored. (Refer to the below A)
- The delay time is fixed with the Trigger Hsync Mode ON.
However, if you use inputting the trigger signals for exposure to start the next video output prior, the line noise appears occasionally by the trigger timing.

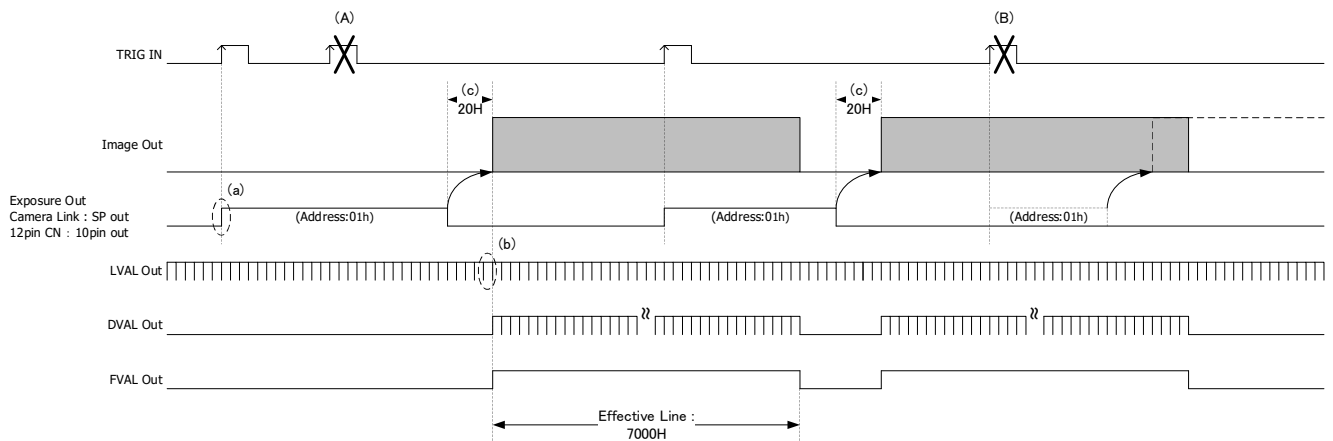

Trigger Hsync mode : (Address:17h)	OFF(Data:0)	ON(Data:1) [Factory setting]
Exposure Time Delay (a)	Exposure Delay 0 	Exposure Delay max1HD 2Tap : max 60us 3Tap : max 45us 4Tap : max 30us 8Tap : max 15us
LVAL signal before rising of FVAL (b)	 The length of LVAL of point (b) is variable.	 LVAL length is always fixed.

5.11. Pulse Width Trigger Shutter Mode

- This is the mode to start exposure with external input trigger signals, and set the exposure time with pulse width of the trigger signals.
- Delay time (Exposure Time Delay) from detecting trigger edge in the camera to starting exposure, and from detecting trigger end edge to completing exposure.
- Pulse width is min. 2HD (min) to approx. 2 frames.

Functionally, there is no upper limitation, but noises such as dark noises and shadings may be noticeable at long time exposure.

- Triggers can be accepted even when outputting video signals.

However, trigger signals for exposure to start the next video output prior to the completion of video transmission for the prior video output signals can not be accepted.

- The delay time is fixed with the Trigger Hsync Mode ON. However, if you use inputting the trigger signals for exposure to start the next video output prior, the line noise appears occasionally by the trigger timing.

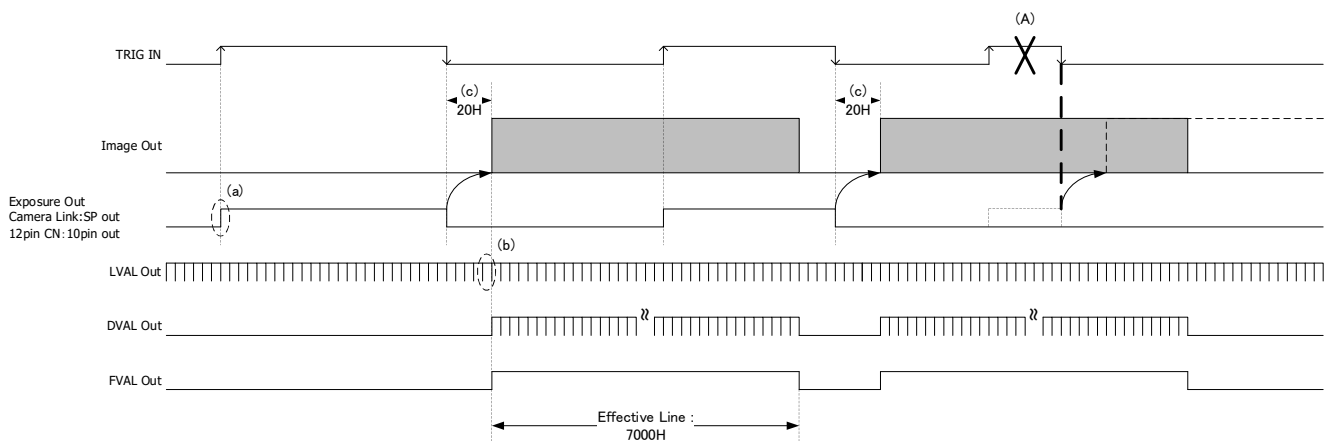

Trigger Hsync mode : (Address: 17h)	OFF(Data:0)	ON(Data:1) [Factory setting]
Exposure Time Delay (a)	<p>Exposure Delay 0</p>	<p>Exposure Delay max1HD</p> <p>2Tap : max 60us 3Tap : max 45us 4Tap : max 30us 8Tap : max 15us</p>
LVAL signal before rising of FVAL (b)	<p>The length of LVAL of point (b) is variable.</p>	<p>LVAL length is always fixed.</p>

6. Partial Scan Mode

- 1 partial area can be set by serial commands.

Function	Address(Hex)	Data(Hex)	
Partial scan mode ON/OFF	08	Full frame scan mode (00h)	
		Partial scan mode (01h)	
Partial scan Start position	40-41	mono	min: 0(0000h) ~ max: 6999(1B57h)
		color	min: 0(0000h) ~ max: 6998(1B56h)
Partial scan Effective line	50-51	mono	min: 1(0001h) ~ max: 7000(1B58h)
		color	min: 2(0002h) ~ max: 7000(1B58h)

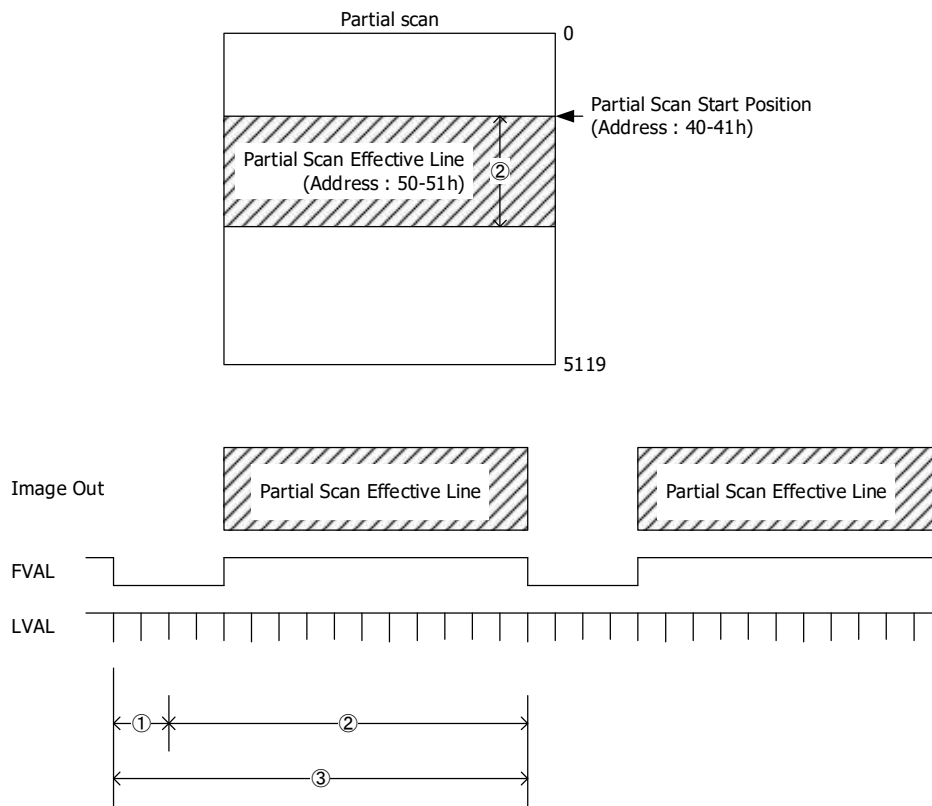

(Example : Effective line : 20 lines)

- ① : 56 lines fixed
- ② : Partial Area : 20 lines
- ③ : Total frame line : 76 lines

- When setting several partial scan areas, please set the start position and effective lines trying not to overlap the areas.
- When setting several areas, please set the areas in the numerical order of start position.
- Entire frame line numbers = **V blanking line numbers (56H fixed)** + Partial effective lines
 Note that "Sum total of partial effective line numbers (except V blanking lines) < **7000** should be met.
- Frame rate = $1 / (\text{Entire frame line numbers} \times \text{Time for 1 line})$

Camera Mode	Time for 1 Line
2Tap Base Configuration	60us
3Tap Base Configuration	45us
4Tap Medium Configuration	30us
8Tap Full Configuration	15us

- Example

	Effective Line Number	Frame Total Line Number	Frame Rate (fps)			
			2Tap Base	3Tap Base	4Tap Medium	8Tap Full
Mono(min)	1	57	292.4	389.9	584.8	1169.6
Color(min)	2	58	287.4	383.1	574.7	1149.4
Vertical:VGA	480	536	31.1	41.5	62.2	124.4
Vertical:XGA	768	824	20.2	27.0	40.5	80.9
Vertical:SXGA	1024	1080	15.4	20.6	30.9	61.7
Vertical:UXGA	1200	1256	13.3	17.7	26.5	53.1
OFF(Max)	7000	7056	2.4	3.1	4.7	9.4

7. Horizontal cutout function

It is possible to cut out the left and right in the horizontal direction with 24 pixels x n. The frame rate does not change even if you cut out the horizontal direction.

Function	Address(Hex)	Data(Hex)
Horizontal cutout	16	min:0(00h) ~ max:194(C2h) min:0=Full frame, 1=left and right 24pixel cut, max:106=left and right 4656pixel cut Cut size (pixel) = setting value x 24

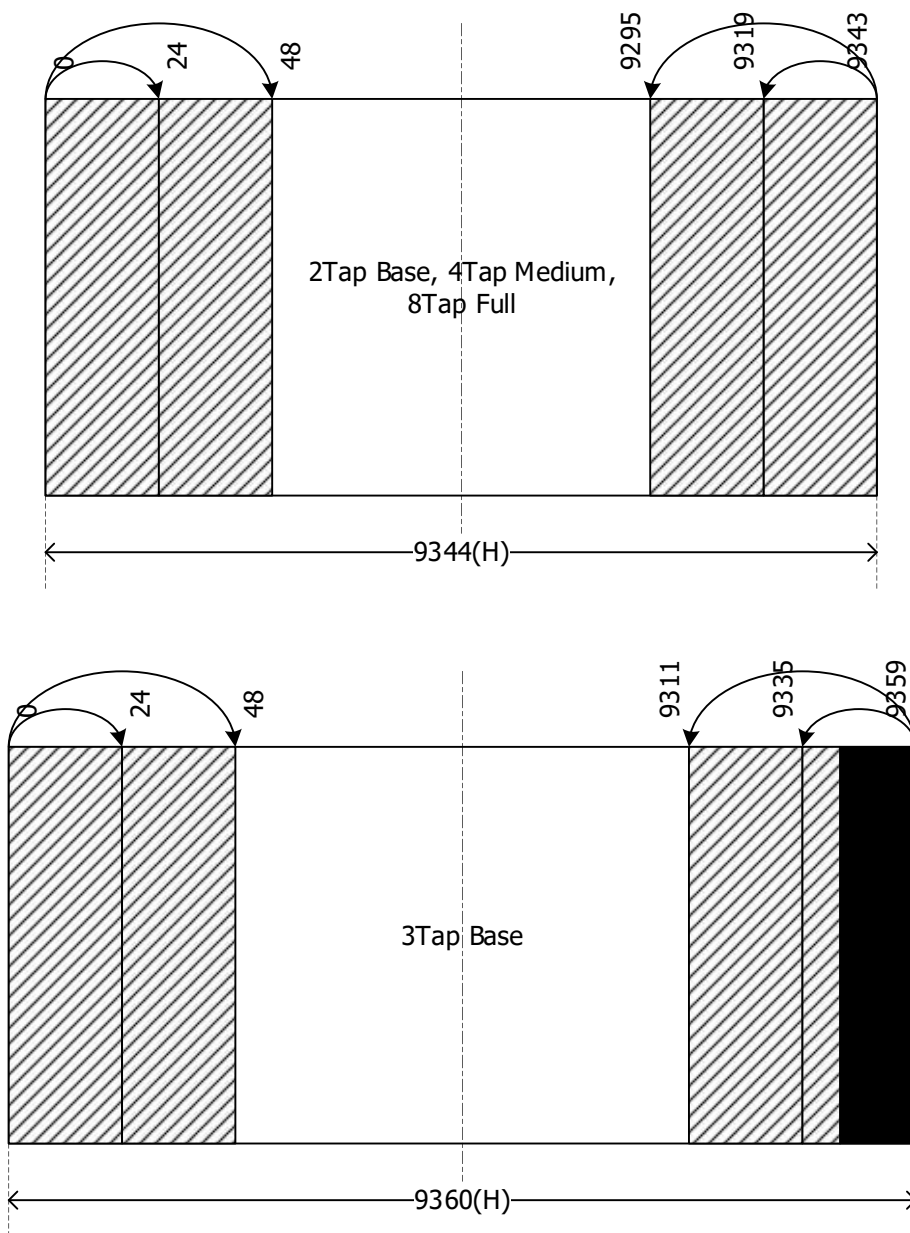

8. Remote Communication

Via camera link cable, the camera can be controlled.

Communication Settings	
Baud Rate	: 115200bps (fixed)
Data	: 8bit
Stop bit	: 1bit
Parity	: None
XON / XOFF	: No Control

- Send Command Format (Host to Camera)

If send a command, set the command and parameter between STX and ETX.

STX (02H)	command (2byte)	parameter (ASCII code) (20H-7FH)	ETX (03H)
--------------	--------------------	-------------------------------------	--------------

- Return Command Format (Camera to Host)

Normally, a camera returns a control code which is ACK or NAK.

If return value has a text message, the message is between STX and ETX.

ACK (06H)	... Succeed
--------------	-------------

NAK (15H)	... Fail
--------------	----------

STX (02H)	command (2byte)	parameter (ASCII code) (2FH- 7FH)	ETX (03H)	... return message
--------------	--------------------	--------------------------------------	--------------	--------------------

- Command List

Command	Function
SR	Set some values of resister
GR	Get some values of resister
SU	Set a user's data
GU	Get a user's data
CS	Save all configurations
CR	Restore all configurations
QM	Get a model name
QS	Get a serial number
QV	Get a firmware version
QE	Get a detail of error information

8.1. Command Specifications

- 1) Set some values of resister

【Command】 Set : Resister

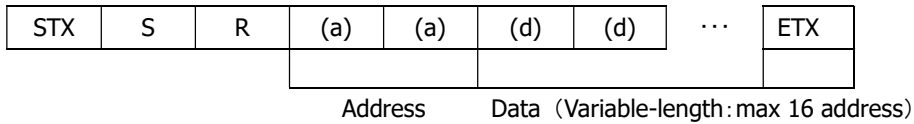

【Return Value】

Succeed	...	ACK
Fail	...	NAK

- 2) Get some value of resister

【Command】 Get : Resister

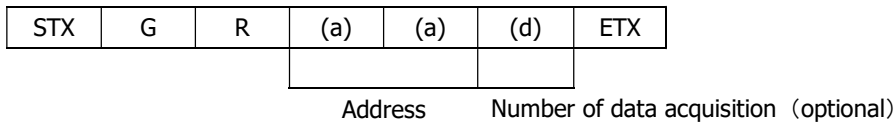

【Return value】

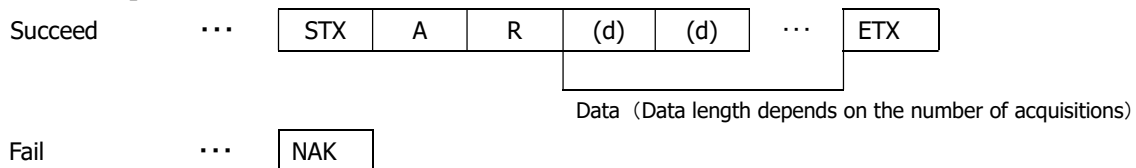

【Remarks】

The command gets some value of register of the specified address. The number of the acquisition is between '0' and 'F'(Hexadecimal).

If appoint '0' at the address, the command send data of 16 address. If the command is omitted at the address, the command send an address.

3) Set User's data

【Command】 Set : User's data

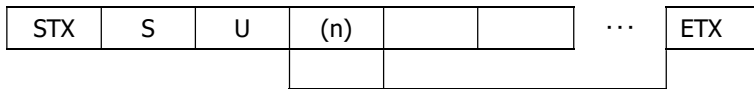

Table No. (0~3)

【Return Value】

Succeed	...	ACK
Fail	...	NAK

【Remarks】

The commands, sets free data on the specified register, and can use 4 tables (1 table : 16 characters).

4) Get User's data

【Command】 Get : User's data

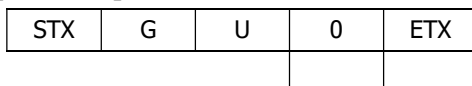
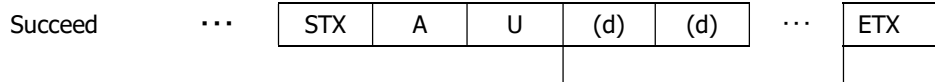

Table No. (0~3)

【Response】



Fail	...	NAK
------	-----	-----

5) Save all configurations

【Command】 Configuration : Save

STX	C	S	ETX
-----	---	---	-----

【Return Value】

Succeed	...	ACK
Fail	...	NAK

6) Restore all configurations

【Command】 Configuration : Restore

STX	C	R	ETX
-----	---	---	-----

【Return Value】

Succeed	...	ACK
Fail	...	NAK

7) Get a model name

【Command】 Query : Model name

STX	Q	M	ETX
-----	---	---	-----

【Return Value】

Succeed	...	STX	R	M	(d)	(d)	...	ETX
					Model name (Fixed length: 16byte)			
Fail	...	NAK						

8) Get a serial number

【Command】 Query : Serial number

STX	Q	S	ETX
-----	---	---	-----

【Return Value】

Succeed	...	STX	R	S	(d)	(d)	...	ETX
					Serial Number(Fixed length: 8byte)			
Fail	...	NAK						

9) Get a firmware version

【Command】 Query : Version

STX	Q	V	ETX
-----	---	---	-----

【Return Value】

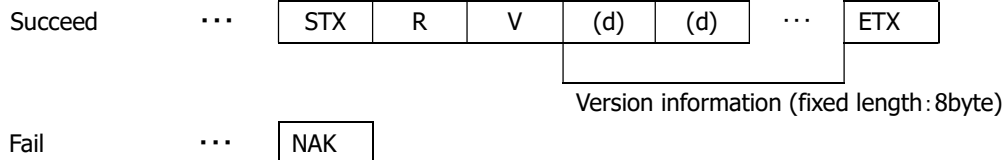

10) Get a detail of error information

【Command】 Query : Error

STX	Q	E	ETX
-----	---	---	-----

【Return Value】

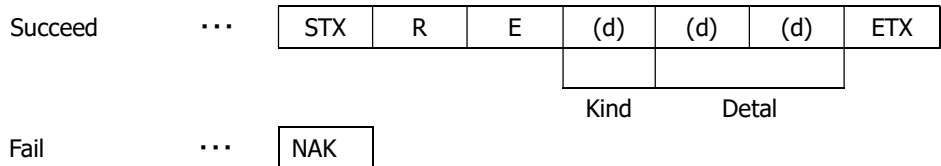

Kind	Detail
0: No Error	00: Normal result
1: Communication Protocol Error	00: The command is undefined.
	01: The command length is more than defined.
	02: The address is undefined.
	03: The value of data is undefined.
	04: The length is more than defined.
	05: The table number is undefined.
	06: The string of user data was abnormal.
2: Internal Control Error	00: Internal control is abnormal.
	01: A read only address was written by the command.
	02: A protected address was written by the command.
	03: Out of range address was written by the command.
	04: The selected table number is abnormal.
	05: The value of the man acquisition area is abnormal.
	06: A function is not implemented.

8.2. Control Example

1) How to check trigger shutter mode. (The command gets a value from address 04)

【Send Command】

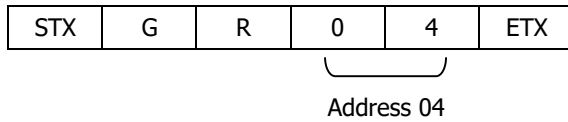

【Return value form camera】

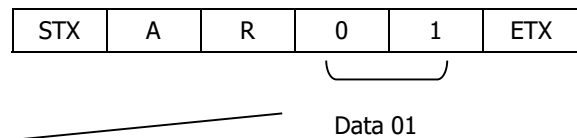

【Receive Return Value】

The camera is working with a trigger shutter mode, because the command received a 01 from the camera.

2) How to check trigger shutter mode. (The command gets consecutive 2 bytes values from address 20)

【Send Command】

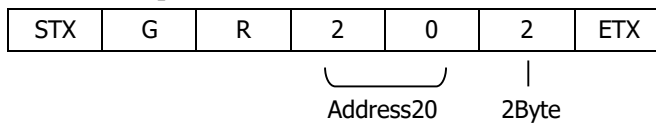

【Receive return value】

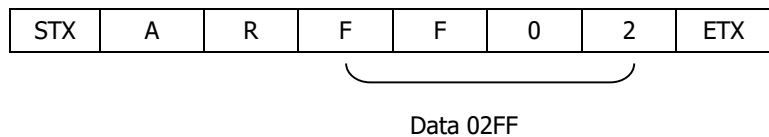

【Receive return value】

The shutter mode of camera is working +12dB, because the command received a 02FF(767) from the camera.

3) How to set partial scan mode. (The command sets 01 for address 08)

【Send Command】

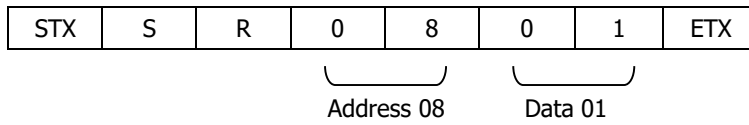

【Return value form camera】

ACK

【Receive Return Value】

The command finished normally, because the command received ACK from the camera.

4) How to set 01FF for manual shutter. (The command set 01FF for address 24)

【Send Command】



【Return value form camera】

ACK

【Receive Return Value】

The command finished normally, because the command received ACK from the camera.

5) How to save configurations of a camera. (The command send CS)

【Send Command】

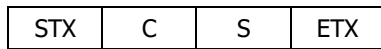

【Return value form camera】

ACK

【Receive Return Value】

The command finished normally, because the command received ACK from the camera.

6) How to restore the camera to initial settings. (The command send CR)

【Send Command】

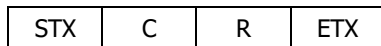

【Return value form camera】

ACK

【Receive Return Value】

The command finished normally, because the command received ACK from the camera.

7) How to get detail of a communication error.

【Send Command】

STX	G	R	@	0	ETX
-----	---	---	---	---	-----

Set the address invalid value



【Return value form camera】

NAK



【Receive return value】

The command finished abnormally, because the command received 'NAK' from the camera.

When the command did not finish normally, retry to send command or send to get detail of a detail error command.

【Send Command】

STX	Q	E	ETX
-----	---	---	-----

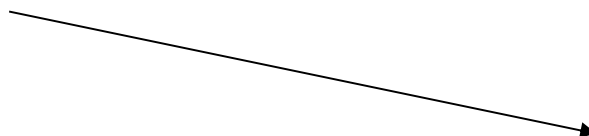

【Return value form camera】

STX	R	E	1	0	2	ETX
-----	---	---	---	---	---	-----

Kind1 Detail 02



【Receive Return Value】

The 'GR' command accessed invalid address , because the error command received kind '1' and detail '02'.

9. Function Setting

Function	Address(Hex)	Data(Hex)				
			2Tap Base	3Tap Base	4Tap Medium	8Tap Full
Preset shutter	01	00:	1/2.4s(OFF)	1/3.1s(OFF)	1/4.7s(OFF)	1/9.4s(OFF)
		01:	1/5s	1/6s	1/9s	1/19s
		02:	1/9s	1/12s	1/19s	1/38s
		03:	1/19s	1/25s	1/38s	1/76s
		04:	1/38s	1/50s	1/76s	1/150s
		05:	1/76s	1/100s	1/150s	1/300s
		06:	1/150s	1/200s	1/300s	1/600s
		07:	1/300s	1/400s	1/600s	1/1200s
		08:	1/600s	1/800s	1/1200s	1/2500s
		09:	1/1200s	1/1500s	1/2500s	1/5000s
		0A:	1/2500s	1/3500s	1/5000s	1/9000s
		0B:	1/4000s	1/5000s	1/7000s	1/12000s
		0C:	1/5000s	1/7000s	1/9000s	1/15000s
		0D:	1/7000s	1/9000s	1/12000s	1/20000s
		0E:	1/12000s	1/15000s	1/20000s	1/25000s
				0F: Manual shutter (Address24-25h)		
Preset white balance (color model)	02	00:	THRU			
		01:	3200K(IRcut filter :C5000)			
		02:	THRU(Spare)			
		03:	Manual			
Trigger shutter	04	00:	Normal (Trigger OFF)			
		01:	Fixed trigger shutter mode (Address 01)			
		02:	Pulse width trigger shutter mode			
Trigger polarity	05	00:	Positive			
		01:	Negative			
Trigger input	06	00:	CC1			
		01:	12pin connector (11pin)			
Partial scan ON/OFF	08	00:	Full frame			
		01:	Partial scan			
Output mode	0A	00:	8Tap Full Configuration			
		01:	4Tap Medium Configuration			
		02:	3Tap Base Configuration			
		03:	2Tap Base Configuration			
Output bit	0B	00:	8bit	8Tap, 4Tap, 3Tap, 2Tap Configuration		
		01:	10bit	8Tap, 4Tap, 2Tap Configuration		
		02:	12bit	4Tap, 2Tap Configuration		

Function	Address(Hex)	Data(Hex)	
Horizontal cutout	16	LL:	min:0(00h) ~ max:194(C2h) min:0=Full frame, 1=left and right 24pixel cut, max:194=left and right 4656pixel cut Cut size(pixel) = setting value x 24
Trigger Hsync mode	17	00:	OFF
		01:	ON
Image flip	18	00:	Normal
		01:	Flip
LED ON/OFF	1B	00:	OFF
		01:	ON
Manual gain	20-21	LLHH:	min:0(0000h) ~ max:767(02FFh) x1(0dB) ~ x4(+12dB) Gain = (setting value+256) / 256
Manual shutter	24-25	LLHH:	min:0(0000h) ~ max:5119(13FFh) 2Tap Base Configuration : Exposure time = 22.25us + (7000 - (setting value)) x 60us min:0=420.0ms, max:5119=82.3us 3Tap Base Configuration : Exposure time = 22.25us + (7000 - (setting value)) x 45us min:0=315.0ms, max:5119=67.3us 4Tap Medium Configuration : Exposure time = 22.25us + (7000 - (setting value)) x 30us min:0=210.0ms, max:5119=52.3us 8Tap Full Configuration : Exposure time = 22.25us + (7000 - (setting value)) x 15us min:0=105.0ms, max:5119=37.3us
Manual white balance R (color model)	28-29	LLHH:	min:0(0000h) ~ max:767(02FFh) x1(0dB) ~ x4(+12dB) Gain = (setting value+256) / 256
Manual white balance B (color model)	2A-2B		
Manual white balance G (color model)	2C-2D		
Partial scan Start position	40-41	LLHH:	mono min:0(0000h) ~ max:6999(1B57h) color min:0(0000h) ~ max:6998(1B56h)
Partial scan Effective line	50-51	LLHH:	mono min:1(0001h) ~ max:7000(1B58h) color min:2(0002h) ~ max:7000(1B58h)

※ LLHH : The data set with 2 Byte shall be set with Low Byte first, then set with High Byte.

< Example > Manual Shutter (Address 24-25h) ->6671(1A0FH)

STX SR 24 0F 1A ETX

10. Dimensions

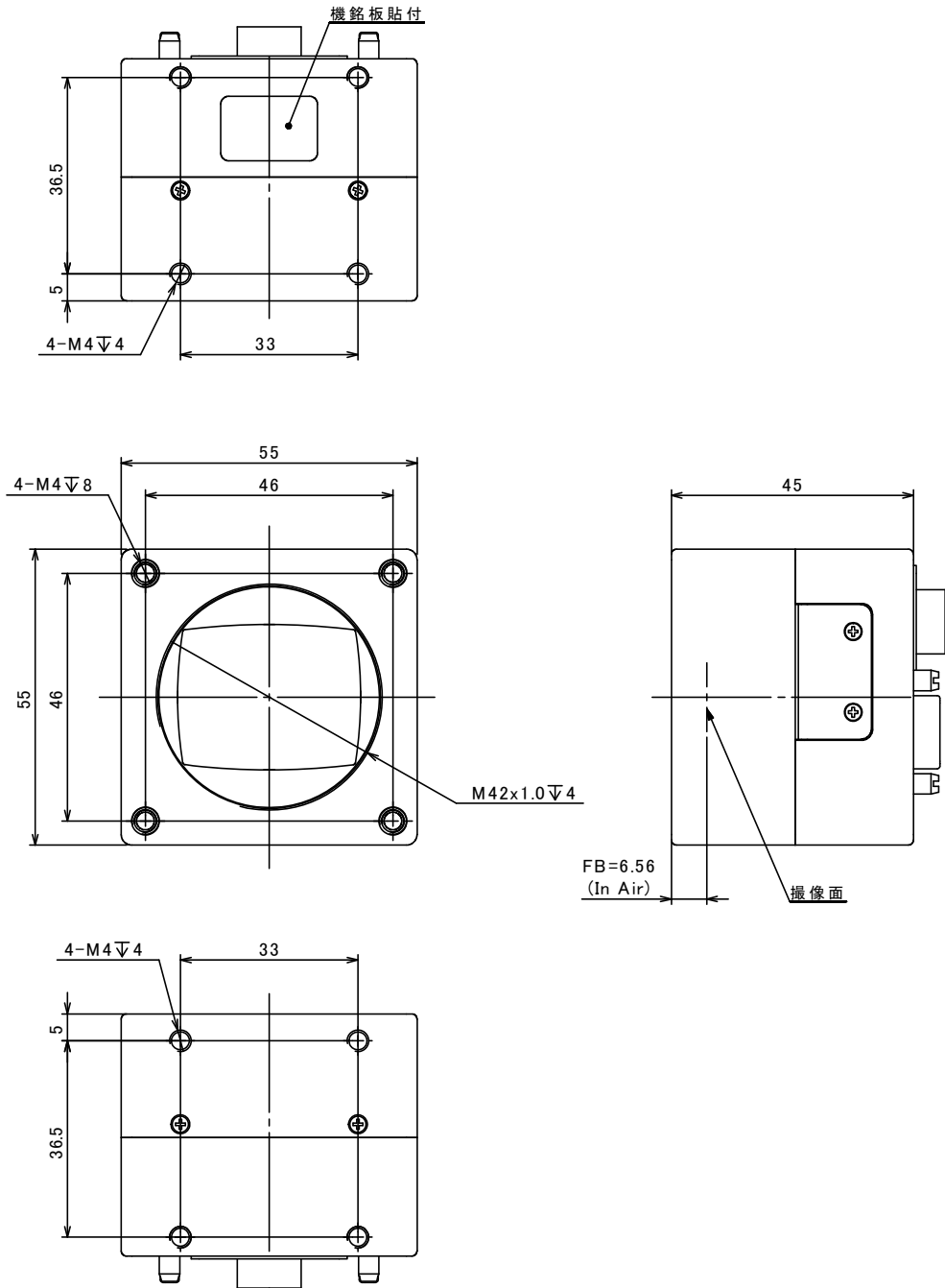

11. Initial Setting

Function	Address	Data	
Preset shutter	01	00:	OFF(1/9.4s)
Preset white balance (color model)	02	01:	3200K
Trigger shutter mode	04	00:	Normal (Trigger OFF)
Trigger polarity	05	00:	Positive
Trigger input	06	00:	CC1
Partial scan	08	00:	Full frame scan mode
Output mode	0A	00:	8Tap Full Configuration
Output bit	0B	00:	8bit
Horizontal cutout	16	00:	0
Trigger Hsync mode	17	01:	ON
Image flip	18	00:	Normal
LED ON/OFF	1B	01:	ON
Manual gain	20-21	0000:	x1(0dB)
Manual shutter	24-25	0000:	OFF(1/9.4s)
Manual white balance R (color model)	28-29	0000:	0dB
Manual white balance B (color model)	2A-2B	0000:	0dB
Manual white balance G (color model)	2C-2D	0000:	0dB
Partial scan Start position	40-41	0000:	Start position 0
Partial scan Effective line	50-51	1400:	Effective line 7000

12. Cases for Indemnity (Limited Warranty)

We shall be exempted from taking responsibility and held harmless for damage or losses incurred by the user in the following cases.

- In case damage or losses are caused by fire, earthquake, or other acts of God, acts by third party, deliberate or accidental misuse by the user, or use under extreme operating conditions.
- In case indirect, additional, consequential damages (loss of business interests, suspension of business activities) are incurred as result of malfunction or non-function of the equipment, we shall be exempted from responsibility for such damages.
- In case damage or losses are caused by failure to observe the information contained in the instructions in this product specification & operation manual.
- In case damage or losses are caused by use contrary to the instructions in this product specification & operation manual.
- In case damage or losses are caused by malfunction or other problems resulting from use of equipment or software that is not specified.
- In case damage or losses are caused by repair or modification conducted by the customer or any unauthorized third party (such as an unauthorized service representative).

13. CMOS Pixel Defect

IDULE compensates the noticeable CMOS pixel defects found at the shipping inspection prior to our shipment. On very rare occasions, however, CMOS pixel defects might be noted with time of usage of the products.

Cause of the CMOS pixel defects is the characteristic phenomenon of CMOS itself and IDULE is exempted from taking any responsibilities for them. Should you have any questions on CMOS pixel defects compensation, please contact us.

14. Product Support

When defects or malfunction of our products occur, and if you would like us to investigate on the cause and repair, please contact your distributors you purchased from to consult and coordinate.
