1.2Mega CMOS Camera

ID1MB-UCL (B/W)

ID1MC-UCL (COLOR)

Technical Manual

iDule Corporation

Table of Contents

	PAGE
1. Product Outline	3
2. Handling Precautions	3
3. Specification	4
3.1.General Specification	4
3.2.Camera Output Signal Specification	5
3.3.Spectral Response (Representative Value)	7
4. Connector	8
4.1.Connector P1	8
4.2.Connector P2	8
4.3.Connector CN1	8
4.4.Connector CN2	9
4.5.LED 1	9
5. Timing Chart	10
5.1. USB3.0 Normal Shutter Mode	10
5.2. USB3.0 Fixed Trigger Shutter Mode	10
5.3.USB2.0 Normal Shutter Mode	11
5.4.USB2.0 Fixed Trigger Shutter Mode	11
5.5.Camera Link 1Tap Base Configuration Normal Shutter Mode Horizontal Synchronous Signals Timing	12
5.6. Camera Link 1Tap Base Configuration Normal Shutter Mode Vertical Synchronous Signals Timing	12
5.7. Camera Link 1 Tap Base Configuration Fixed Trigger Shutter Mode Horizontal Synchronous Signals Timing	13
5.8. Camera Link 1Tap Base Configuration Fixed Trigger Shutter Mode Vertical Synchronous Signals Timing	13
5.9. Camera Link 2Tap Base Configuration Normal Shutter Mode Horizontal Synchronous Signals Timing	14
5.10. Camera Link 2Tap Base Configuration Normal Shutter Mode Vertical Synchronous Signals Timing	14
5.12. Camera Link 2Tap Base Configuration Fixed Trigger Shutter Mode Horizontal Synchronous Signals Timing	15
5.13. Camera Link 2Tap Base Configuration Fixed Trigger Shutter Mode Vertical Synchronous Signals Timing	15
5.14. Camera Link Base Configuration 24bit – RGB Normal Shutter Mode Horizontal Synchronous Signals Timing	16
5.15. Camera Link Base Configuration 24bit – RGB Normal Shutter Mode Vertical Synchronous Signals Timing	16
5.16. Camera Link Base Configuration 24bit – RGB Fixed Trigger Shutter Mode Horizontal Synchronous Signals Timing	17
5.17. Camera Link Base Configuration 24bit – RGB Fixed Trigger Shutter Mode Vertical Synchronous Signals Timing	17
5.18.Output Format	18
5.19.Fixed Trigger Shutter Mode	20
6. Partial Scan Mode	21
7. UVC Extension Units (USB) Remote Communication	23
8. Serial Port (Camera Link) Remote Communication	23
8.1.Command Specifications	24
8.2.Control Example	28
9. Function Setting	32
10. Dimensions	36
11. Initial Setting	37
12. Cases for Indemnity (Limited Warranty)	38
13. CMOS Pixel Defect	38
14. Product Support	38

1. Product Outline

ID1MB-UCL/ID1MC-UCL is a Camera Link and USB3.0/2.0 interfaced and 1.2Mega resolution camera module. 1.2Mega pixels CMOS sensor with diagonal length 6.0mm is utilized. Entire pixels can be read out within 1/54s.

Features

- Global Shutter CMOS sensor is utilized.
- Camera Link Base Configuration is supported.
- USB (UVC) YUV / RAW is supported.
- External trigger shutter mode is operable.
- USB Bus power, PoCL , 12pin power supply.

2. Handling Precautions

The camera must not be used for any nuclear equipment or aerospace equipment with which mechanical failure or malfunction could result in serious bodily injury or loss of human life. Our warranty does not apply to damages or defects caused by irregular and /or abnormal use of the product.

Please observe all warnings and cautions stated below.

Our warranty does not apply to damages or malfunctions caused by neglecting these precautions.

Do not use or store the camera in the following extreme conditions :

- Extremely dusty or humid places.
 - Extremely hot or cold places (operating temperature 0°C to +40°C).
 - Close to generators of powerful electromagnetic radiation such as radio or TV transmitters.
 - Places subject to fluorescent light reflections.
 - Places subject to unstable (flickering, etc.) lighting conditions.
 - Places subject to strong vibration.
-
- Remove dust or dirt on the surface of the lens with a blower.
 - Do not apply excessive force or static electricity that could damage the camera.
 - Do not shoot direct images that are extremely bright (e.g., light source, sun, etc.), and when camera is not in use, put the lens cap on.
 - Confirm the mutual ground potential carefully and then connect the camera to monitors or computers. AC leaks from the connected devices may cause damages or destroy the camera.
 - Do not apply excessive voltage. (Use only the specified voltage.) Unstable or improper power supply voltage may cause damages or malfunction of the camera.
 - The voltage ripple of camera power DC +12V±10% shall be within ±50mV. Improper power supply voltage may cause noises on the video signals.
 - The rising time of camera power supply voltage shall be less than +10V, Max 60ms. Please avoid noises like chattering when rising.

3. Specification

3.1.General Specification

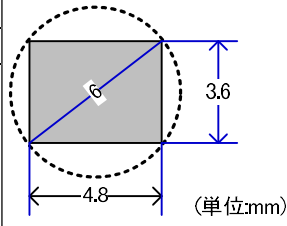
(1) Image Sensor	Type	Diagonal length 6.0mm Global Shutter (OnSemi AR0135)	
	Effective Pixel Number	1288(H) x 972(V)	
	Cell Size	3.75 μ m(H) x 3.75 μ m(V)	
	Image Circle	Φ 6.0mm	
			
(2) Video Output Frequency	Pixel CLK	USB : 74.25MHz Camera Link 1Tap / 24bit-RGB : 74.25MHz Camera Link 2Tap : 37.125MHz	
	Output effective pixel number	1284(H) x 962(V)	
	USB3.0	54.08fps	1388(H) x 989(V) : with Blanking
	USB2.0	15.01fps	5000(H) x 989(V) : with Blanking
	Camera Link	54.08fps	1388(H) x 989(V) : with Blanking
(3) Video Output	USB3.0/2.0 : UVC (YUV,RAW) Camera Link : 1Tap Base Configuration, 2 Tap Base Configuration, Base Configuration 24bit – RGB		
(4) Output Format	Sensor AD	12bit	
	USB3.0/2.0	8bit	
	Camera Link	8bit / 10bit / 12bit	
(5) Sensitivity	B/W	F8	2000lx
	Color	F5.6	2000lx
at shutter speed 1/54s(OFF), Gain 0dB			
(6) Minimum Illumination	B/W	F1.4	4lx
	Color	F1.4	8lx
at shutter speed 1/54s(OFF), Gain +12dB			
(7) Power Requirements	USB Bus Power : DC+5V \pm 5% 12pin / PoCL : DC+12V \pm 10%		
(8) Power Consumption	typ 2.0 W max 2.4 W		
(9) Dimensions	CHU : ϕ 14.0mm L:54.0mm excluding projection Head Cable : ϕ 3.0mm L:2000mm CCU : W:96.0mm D:50.0mm H:25mm excluding projection		
(10) Weights	Approx. 110g (CHU:7g)		
(11) Lens Mount	M12 Mount		
(12) Gain	0dB ~ +12dB		
(13) Shutter Speed	USB3.0 / Camera Link (Normal Mode) : OFF(1/54s) ~ 1/54000s		
	USB3.0 / Camera Link (Trigger Mode) : OFF(1/45s) ~ 1/45000s		
	USB2.0 : OFF(1/15s) ~ 1/15000s		
(14) Trigger Mode	Fixed Trigger Shutter Mode		
(15) Partial Scan	Full Frame ~ 4 Line		Partial Area : 1area
(16) Safety/ Quality Standards	CE	To be applied for EN61000-6-4:2007+A1 To be applied for EN61000-6-2:2005	
	RoHS: Conform to RoHS		
(17) Durability	Vibration	20~200 Hz, 98m/s ² (10G), X,Y and Z directions (120 min for each direction)	
	Shock	No malfunction shall be occurred with 980m/s ² (100G) for \pm X, \pm Y, \pm Z, 6 directions. (without package)	
(18) Environment	Operation	0 $^{\circ}$ C ~ +40 $^{\circ}$ C Humidity 0 ~ 90%RH	
	Storage	-25 $^{\circ}$ C ~ +65 $^{\circ}$ C Humidity 0 ~ 90%RH	

3.2. Camera Output Signal Specification

3.2.1. USB3.0 / 2.0

(1)Video Output Data	Effective Video Output	1284(H) × 962(V)	
(2)Video Signals	White Clip Level	FFh	(at gain 0dB)
	Setup Level	Under 0Ch	
	Dark Sharding	Both horizontal and vertical should be under 00Fh	

3.2.2. Camera Link

(1)Video Output Data	Effective Video Output	1284(H) × 962(V)	
(2)Sync Signal Output	LVAL	Camera Link (LVDS)	
	FVAL		
	DVA		
	SP(Exposure Signal)		
(3)Camera Control Signal Input	CC2·CC3·CC4	Camera Link Input(LVDS)	
(4)Trigger Input	Polarity	Positive/Negative Selectable	(Address 05)
	CC1	Camera Link Input (LVDS)	(Address 06)
(5)Serial Communication	SerTC	Camera Link (LVDS)	(Serial to Camera)
	SerTFG	Camera Link (LVDS)	(Serial to Frame Grabber)
(6)Video Signals	White Clip Level	FFEh	(at Gain 0dB, 12bit)
	Setup Level	under 0C0h	
	Dark Shading	Both horizontal and vertical should be under 0FFh	

3.2.3. External Input / Output

(1)Trigger in CN1	CN1 : 1pin	Low1.4V(max),High3.3V~5.0V	(Address 06)
	Polarity	Positive / Negative	(Address 05)
(2)Trigger in CN2	CN2 : 11pin	Low1.4V(max),High3.3V~5.0V	(Address 06)
	Polarity	Positive / Negative	(Address 05)
(3)Exposure signal CN2	CN2 : 6pin	Low0.55V(max),High3.8V(min)	
(4)FVAL signal CN2	CN2 : 7pin	Low0.55V(max),High3.8V(min)	

Trigger in CN1(2pin), CN2(12pin)

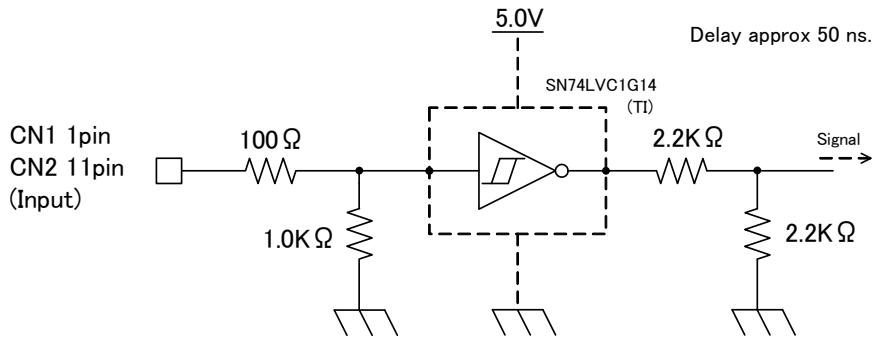

Exposure signal CN2 / FVAL signal CN2

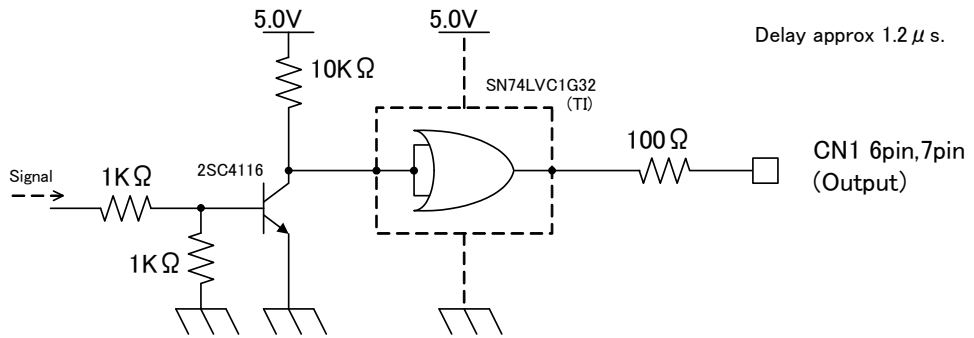

3.3.Spectral Response (Representative Value)

ID1MB-UCL (B/W)

NOT FOR PUBLIC RELEASE

AR0135CS

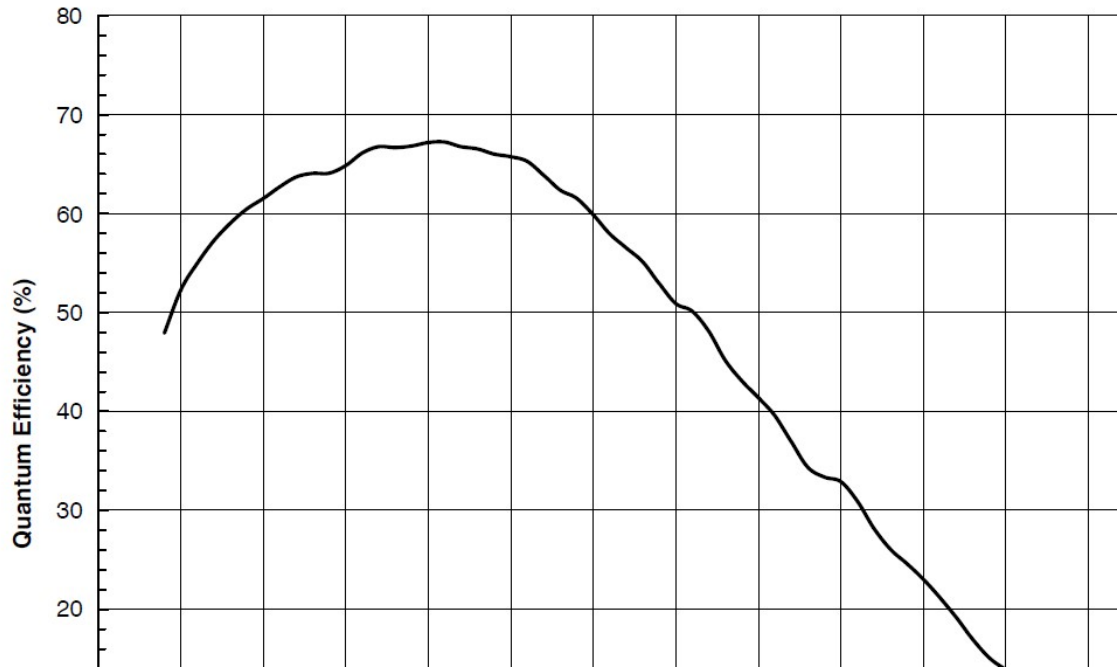

ID1MC-UCL (Color)

Figure 23. Quantum Efficiency - Monochrome Sensor (Typic

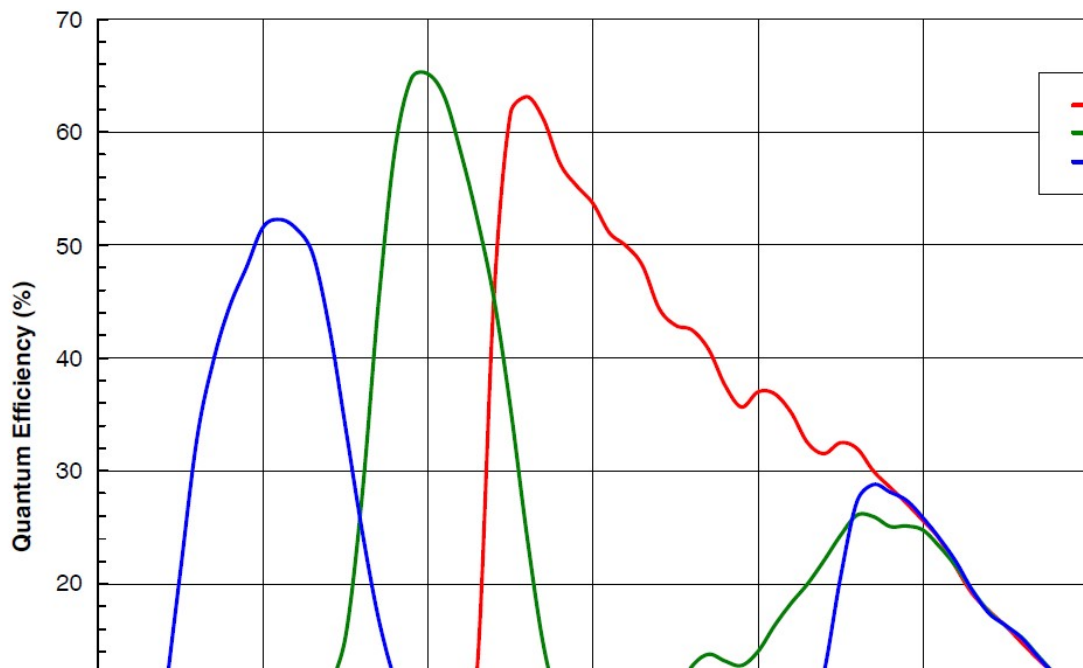

4. Connector

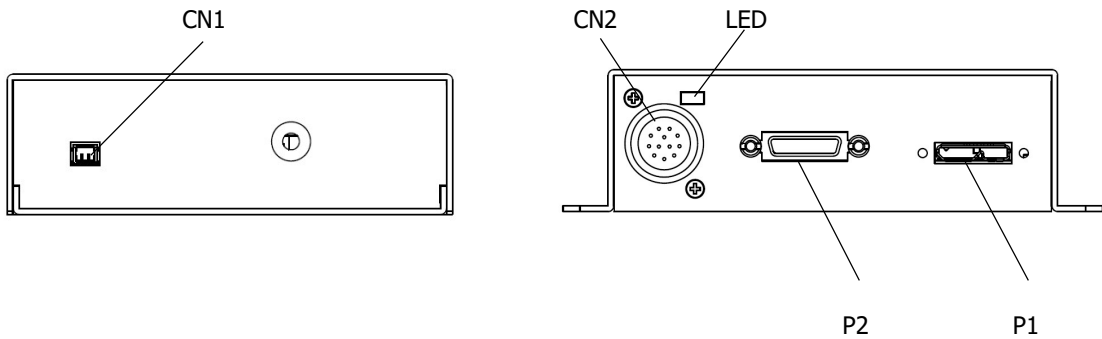

4.1.Connector P1

USB3.0 Micro B Connector
USB Bus Power

4.2.Connector P2

Camera Link Connector 12226-1100-00PL (3M)
PoCL

4.3.Connector CN1

2pin external trigger in 53261-0271 (molex)

Pin NO	Name
1	Trigger in
2	GND

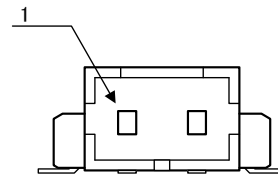

53261-0271 : molex

4.4.Connector CN2

12pin external Input / Output Connector HR10A-10R-12PB(72) HIROSE

PIN NO	
1	GND
2	Power Input (DC+12V)
3	GND
4	NC
5	GND
6	FVAL signal out
7	Exposure signal out
8	GND
9	NC
10	NC
11	Trigger in
12	GND

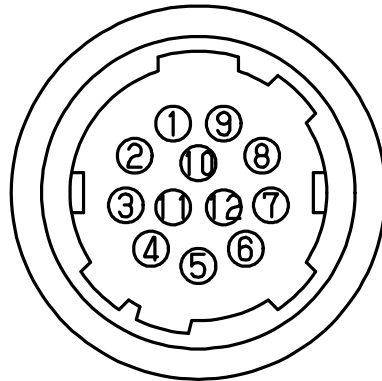

4.5.LED 1

Power LED

Lights up when the camera is operational.

If the power is not supplied or the camera is broken, LED will not light up.

You can turn off the LED by communication setting.

5. Timing Chart

5.1. USB3.0 Normal Shutter Mode

After CMOS sensor is finished to expose, start to translate USB data.
USB translate timing is not fixed.

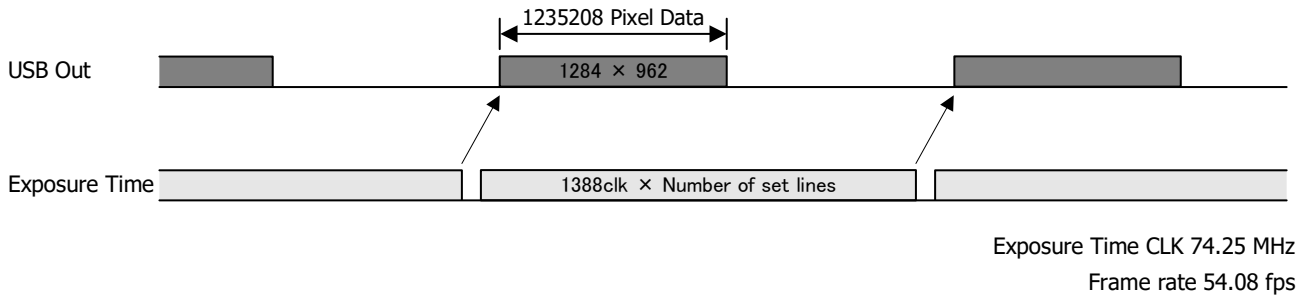

5.2. USB3.0 Fixed Trigger Shutter Mode

After CMOS sensor is finished to expose, start to translate USB data.
Frame Rate depend on trigger timing and exposure time.
USB translate timing is not fixed.

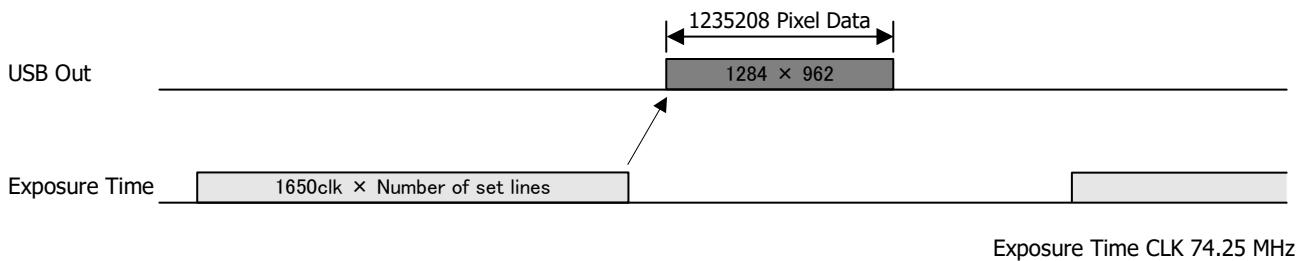

5.3.USB2.0 Normal Shutter Mode

After CMOS sensor is finished to expose, start to translate USB data.
USB translate timing is not fixed.

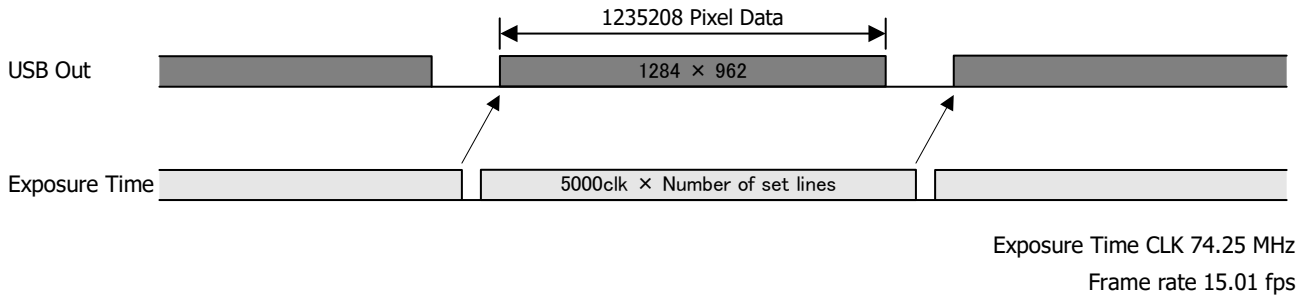

5.4.USB2.0 Fixed Trigger Shutter Mode

After CMOS sensor is finished to expose, start to translate USB data.
Frame Rate depend on trigger timing and exposure time.
USB translate timing is not fixed.

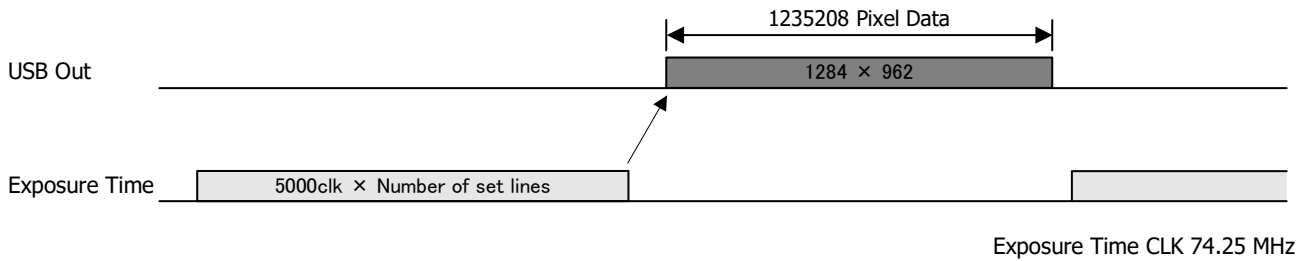

5.5. Camera Link 1Tap Base Configuration Normal Shutter Mode Horizontal Synchronous Signals Timing

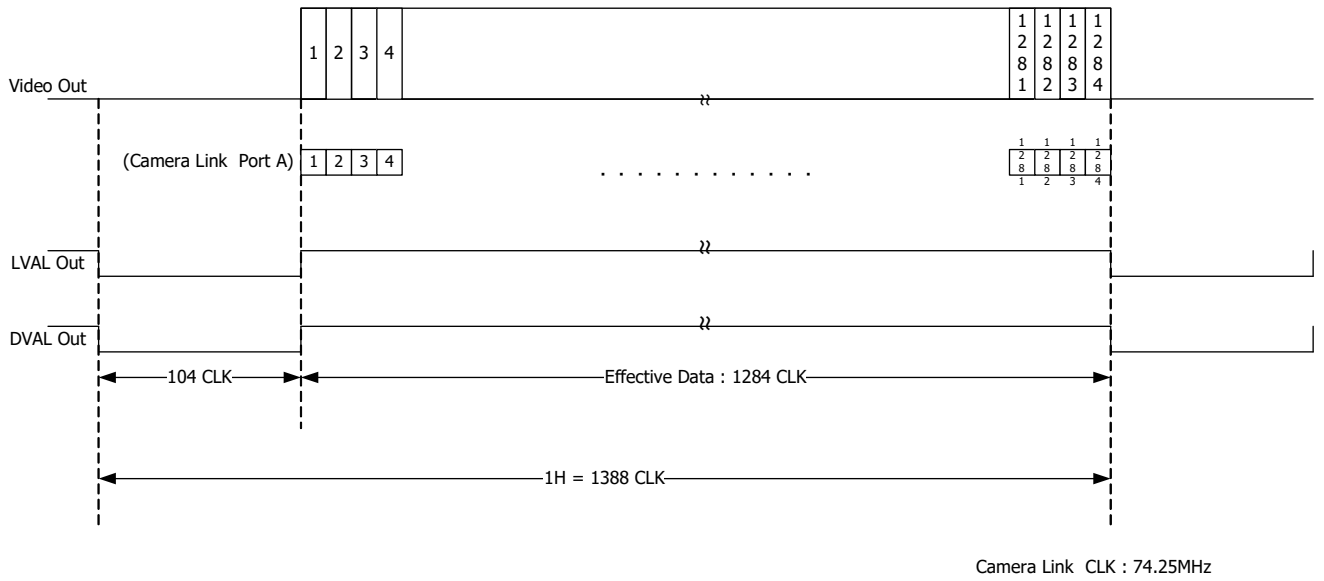

5.6. Camera Link 1Tap Base Configuration Normal Shutter Mode Vertical Synchronous Signals Timing

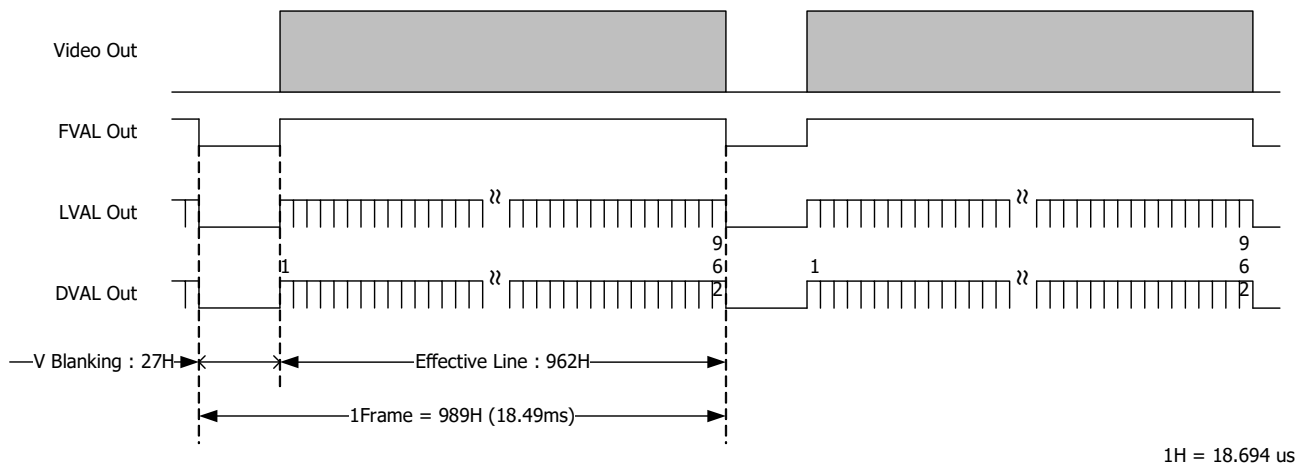

5.7. Camera Link 1 Tap Base Configuration Fixed Trigger Shutter Mode Horizontal Synchronous Signals Timing

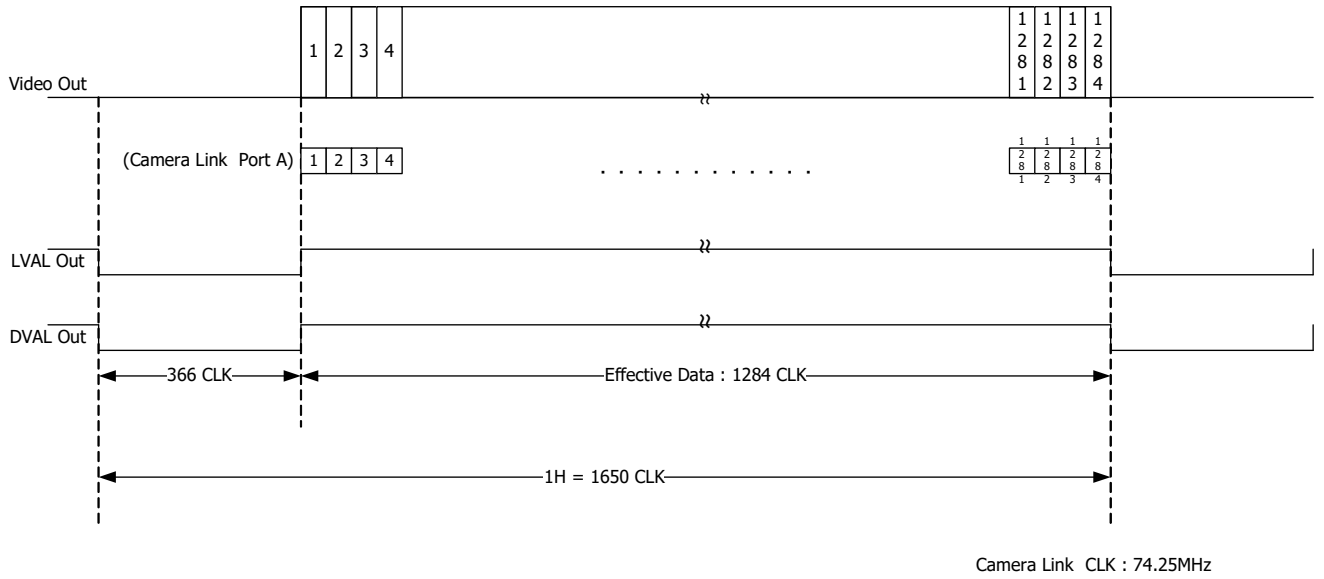

5.8. Camera Link 1 Tap Base Configuration Fixed Trigger Shutter Mode Vertical Synchronous Signals Timing

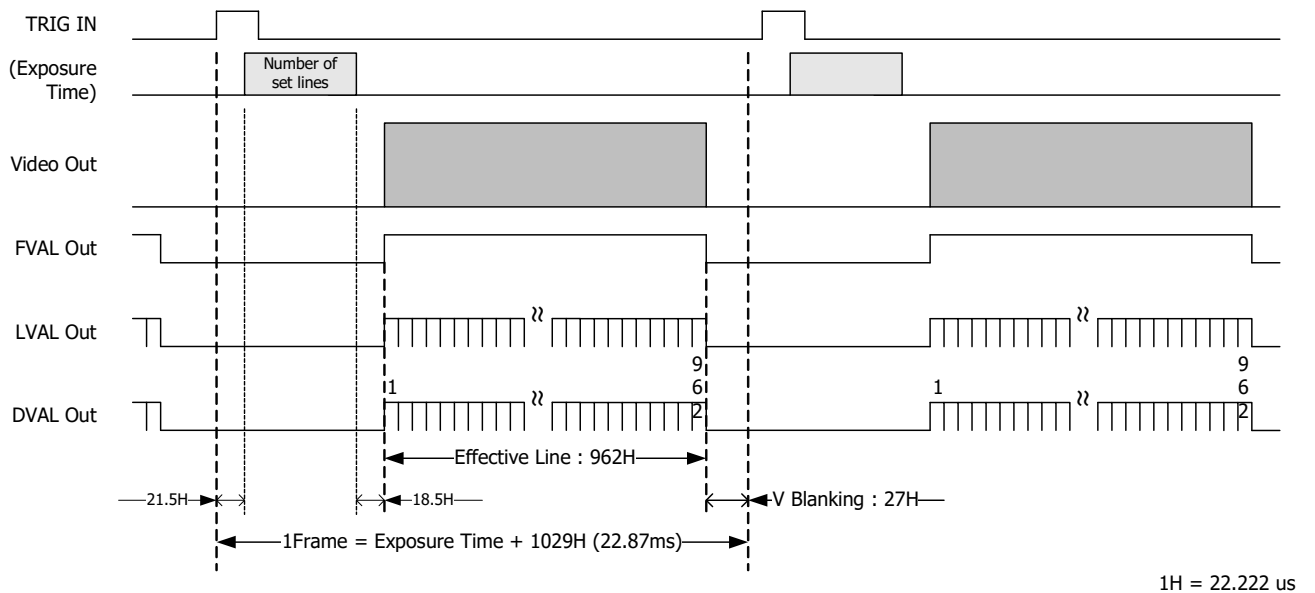

5.9. Camera Link 2Tap Base Configuration Normal Shutter Mode Horizontal Synchronous Signals Timing

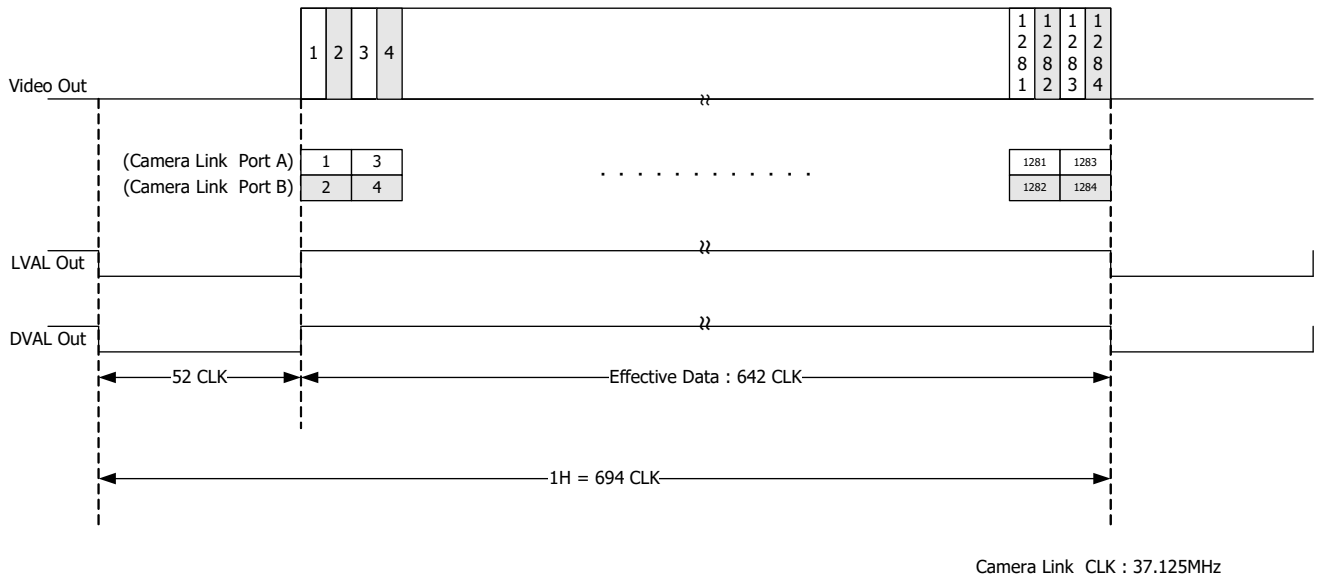

5.10. Camera Link 2Tap Base Configuration Normal Shutter Mode Vertical Synchronous Signals Timing

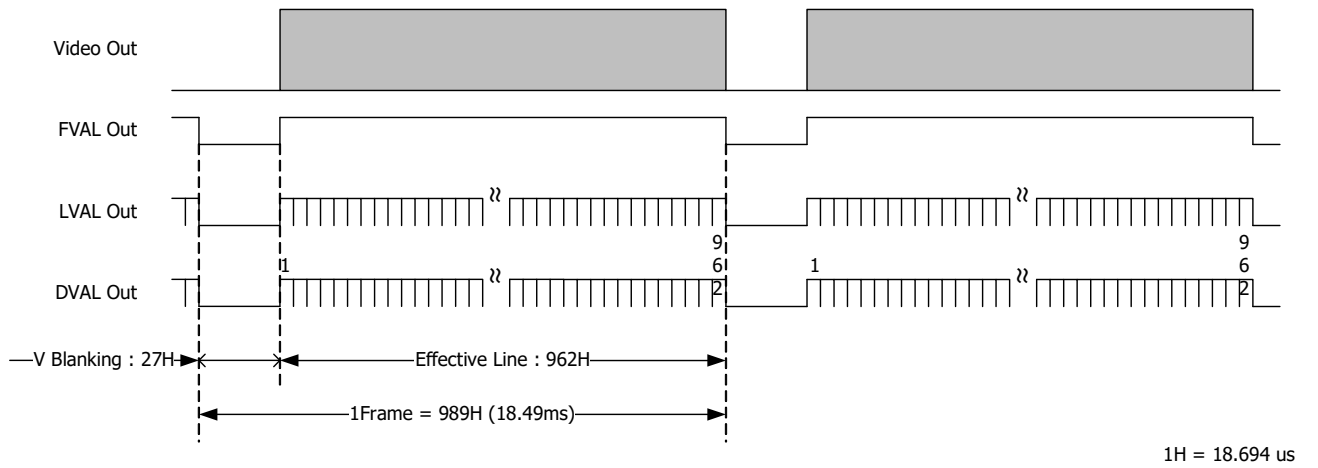

5.12. Camera Link 2Tap Base Configuration Fixed Trigger Shutter Mode Horizontal Synchronous Signals Timing

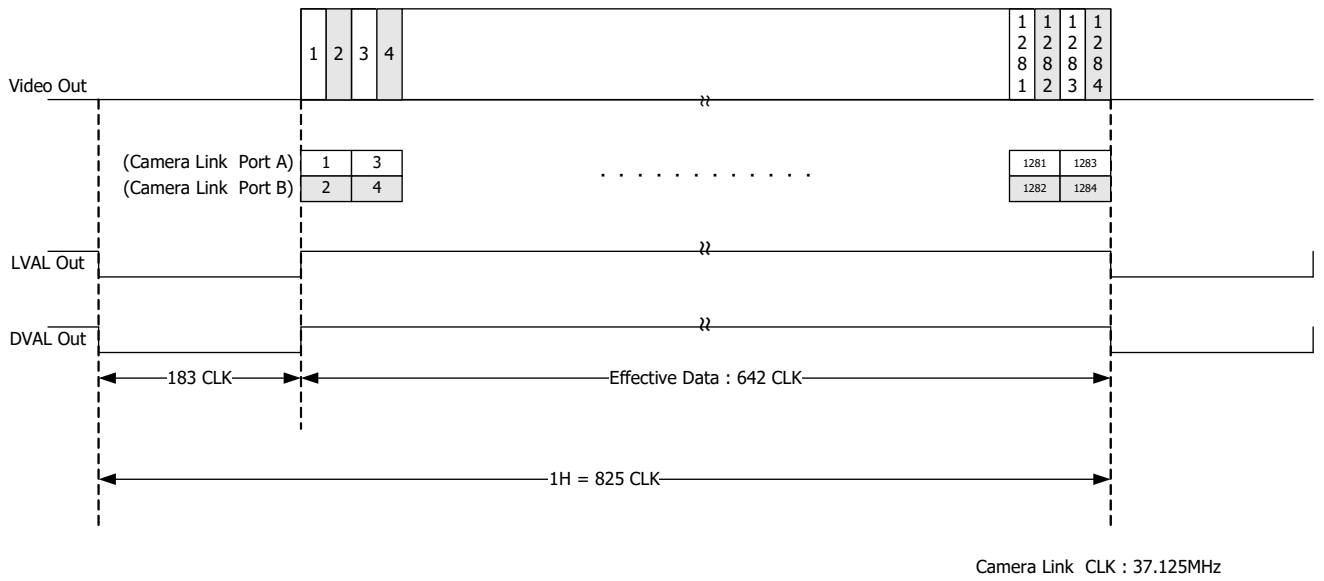

5.13. Camera Link 2Tap Base Configuration Fixed Trigger Shutter Mode Vertical Synchronous Signals Timing

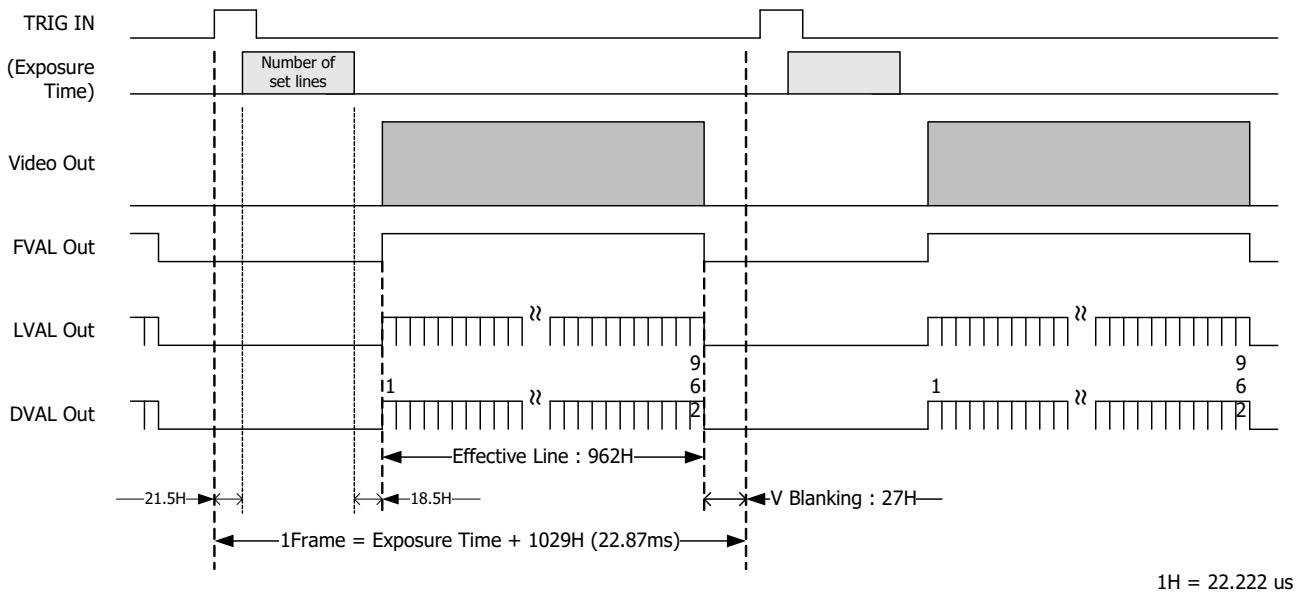

5.14. Camera Link Base Configuration 24bit – RGB Normal Shutter Mode Horizontal Synchronous Signals Timing

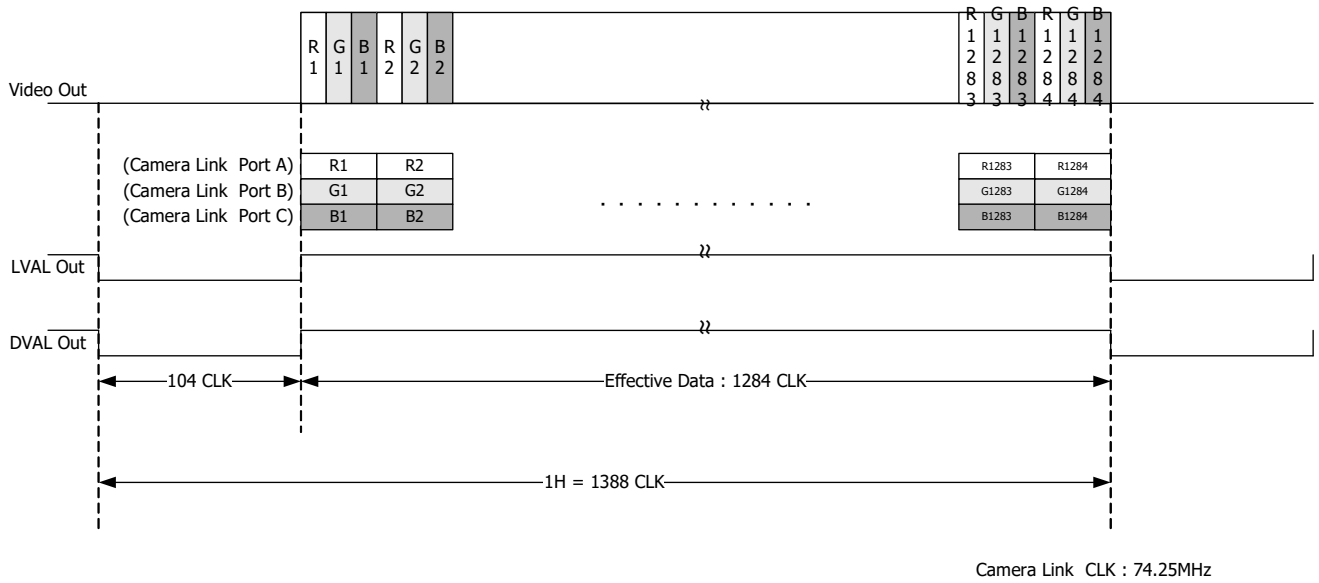

5.15. Camera Link Base Configuration 24bit – RGB Normal Shutter Mode Vertical Synchronous Signals Timing

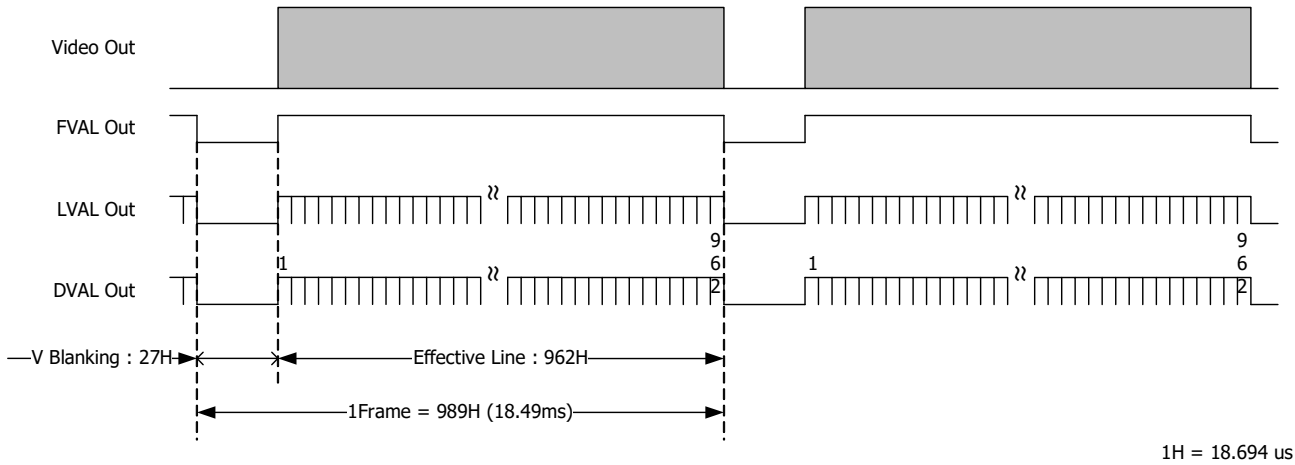

5.16. Camera Link Base Configuration 24bit – RGB Fixed Trigger Shutter Mode Horizontal Synchronous Signals Timing

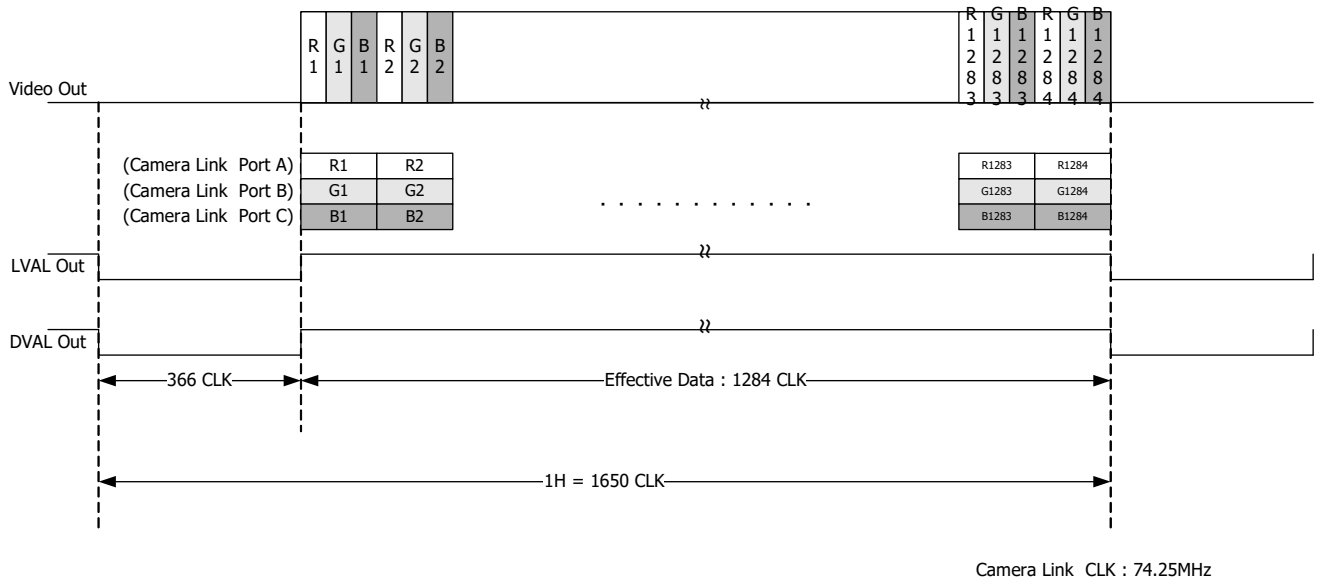

5.17. Camera Link Base Configuration 24bit – RGB Fixed Trigger Shutter Mode Vertical Synchronous Signals Timing

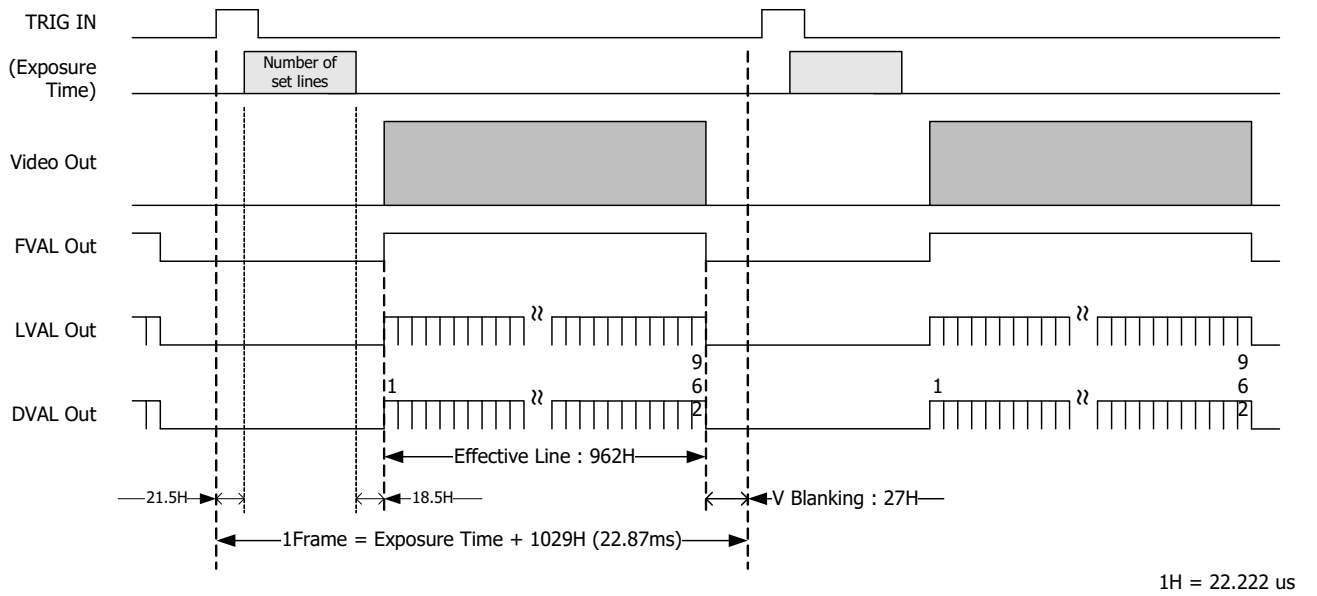

5.18. Output Format

USB3.0 / 2.0 UVC

ID1MB-UCL

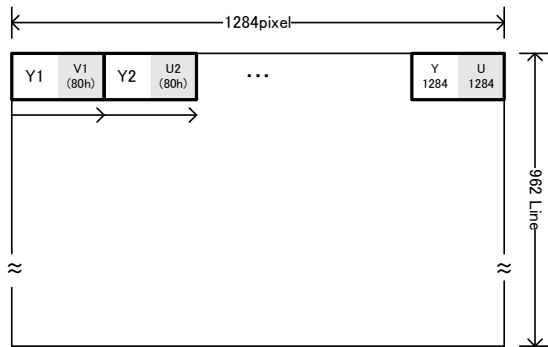

ID1MC-UCL (YUV)

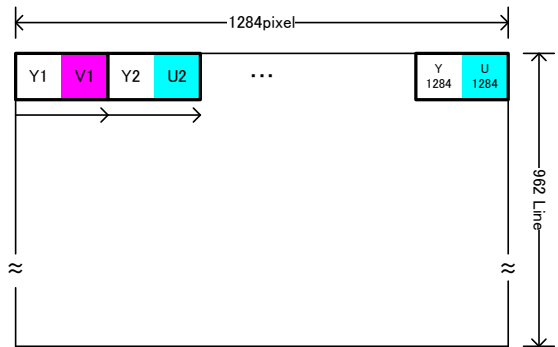

ID1MC-UCL (RAW)

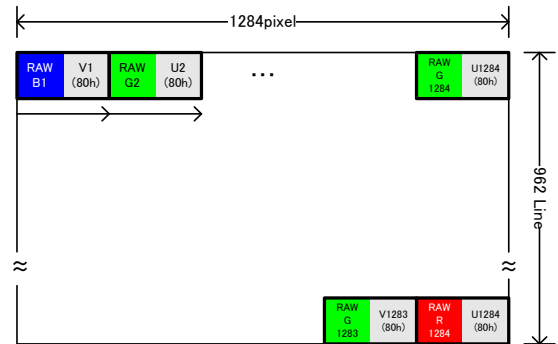

Camera Link 1Tap Base Configuration

ID1MB-UCL

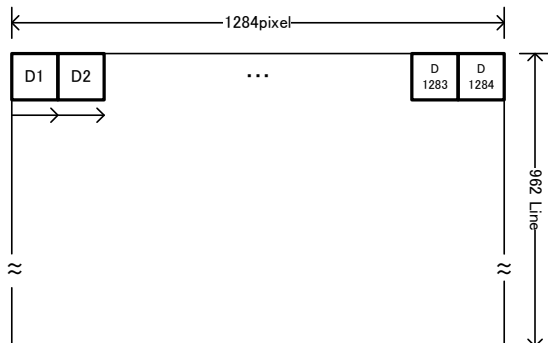

ID1MC-UCL

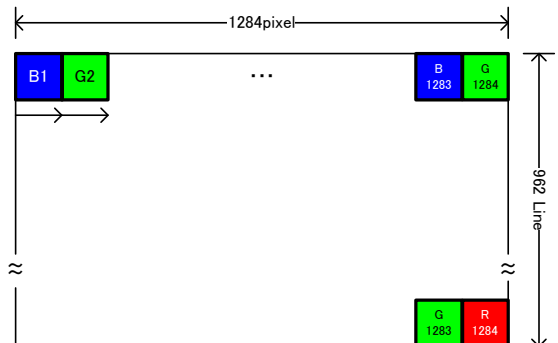

Camera Link 2Tap Base Configuration

ID1MB-UCL

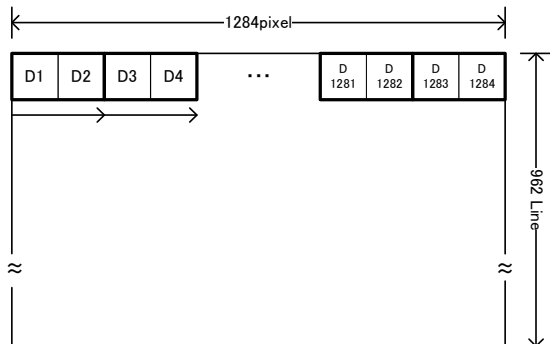

ID1MC-UCL

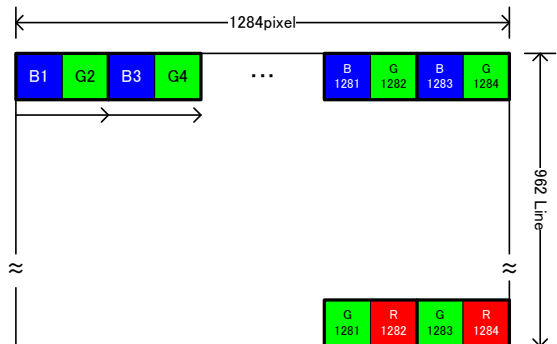

Camera Link Base Configuration 24bit – RGB

ID1MC-UCL

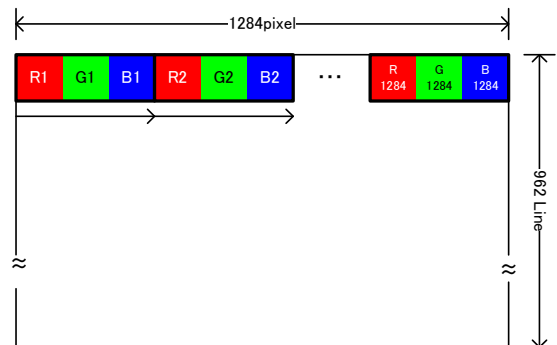

5.19.Fixed Trigger Shutter Mode

- This is the mode to start exposure with external input trigger signals, and set the exposure time with serial commands.
- Delay time (Exposure Time Delay) from detecting trigger edge in the camera to starting exposure is as below.

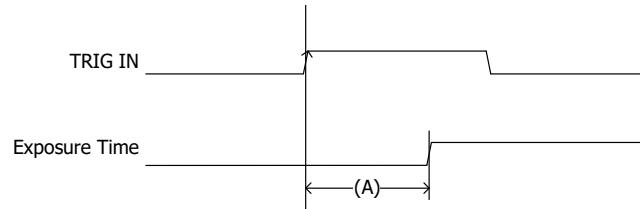

* Exposure Time Delay (A)

•USB3.0 / Camera Link	477 us	(21.5H)	*1H = 22.22 us
•USB2.0	841 us	(12.5H)	*1H = 67.34 us

Exposure Time Delay with soft trigger input is unquestionable.

- Triggers cannot be accepted even when exposing and outputting video signals.
Possible trigger input intervals : Exposure Time Delay + Exposure Time + Effective Line + 45.5H
*Trigger input during exposure time should be ignored. (Refer to the below A)

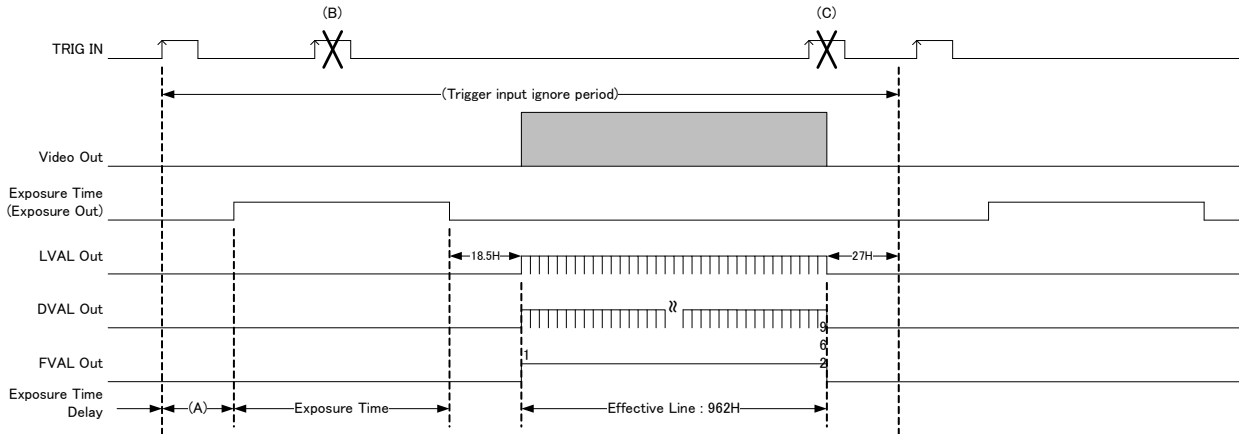

6. Partial Scan Mode

- 1 partial area can be set by serial commands.

Partial Scan Setting

Partial Scan Start Position Address : 40 - 41
 Partial Scan Effective Line Number Address : 50 - 51

Example

Normal Shutter Mode

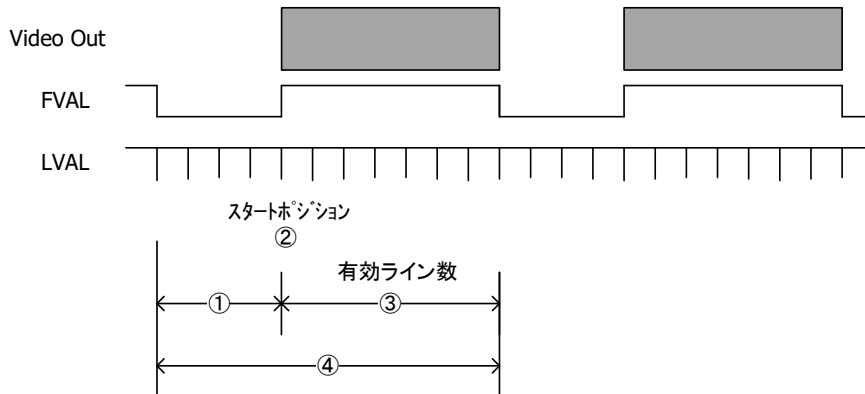

- ① : V Blanking : 27H fixed
- ② : Partial Scan Start Position : 120H
- ③ : Partial Scan Effective Line Number : 400H
- ④ : Total Lines : 507H(①+③)

Fixed Trigger Shutter Mode *USB3.0, Exposure time 1/1000s (45H)

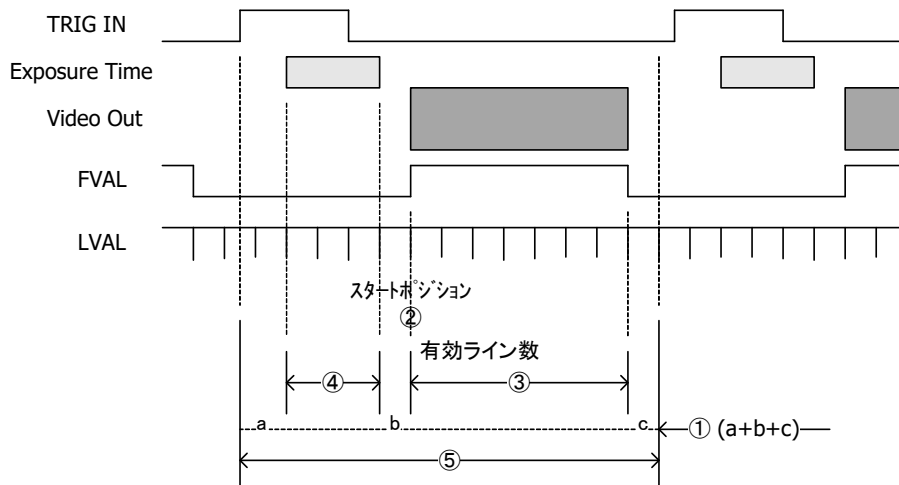

- ① : V Blanking : 67H
- ② : Partial Scan Start Position : 120H
- ③ : Partial Scan Effective Line Number : 480H
- ④ : Exposure Time Line Number : 45H
- ⑤ : Total Lines : 592H(①+③+④)

- Please set the start position : 2 x n and effective lines : 4 x n (max 962).

Start Position + Effective Line Numbers <= 962

- Frame Total Lines time

Normal Shutter Mode

= **V blanking line number (27H fixed)** + Partial Scan Effective line numbers

Fixed Trigger Shutter Mode

= Exposure Time + **V blanking line number** + Partial Scan Effective line numbers

- Frame Rate = 1 / (Total lines x Time for 1 line)

Time for 1 line = 18.69us(USB3.0/CL :Normal Mode) / 22.22us(USB3.0/CL Trigger Mode) / 67.34us(USB2.0)

- Example (Normal Shutter)

Effective Line Number	Frame Rate (Total Line Number)	
	USB3.0 / Camera Link	USB2.0
4H (min)	1725.6fps (31H)	479.03fps (31H)
320H	154.1 (347)	42.79 (347)
480H	105.5 (507)	29.28 (507)
640H	80.201 (667)	22.26 fps(667)
720H	71.61 (747)	19.87 (747)
962H (max)	54.08 (989)	15.01 (989)

- Example (Fixed Trigger Shutter) Ex Time : 1/1000s (45H)

Effective Line Number	Ex Time Line	Frame Rate (Total Line Number)	
		USB3.0 / Camera Link	USB2.0
4H (min)	45H	387.9fps (116H)	138.7fps (107H)
320H	45H	104.1 (432)	35.106 (423)
480H	45H	76.01 (592)	25.47 (583)
640H	45H	59.84 (752)	19.98 (743)
720H	45H	54.08 (832)	18.04 (823)
962H (max)	45H	41.89 (1074)	13.94 (1065)

7. UVC Extension Units (USB) Remote Communication

Camera function is changed by SDK.

8. Serial Port (Camera Link) Remote Communication

Communication Settings	
Baud Rate	: 9600bps (Initial Setting)
Data	: 8bit
Stop bit	: 1bit
Parity	: None
XON / XOFF	: No Control

- Send Command Format (Host to Camera)

If send a command, set the command and parameter between STX and ETX.

STX (02H)	Command (2byte)	Parameter(ASCII code) (20H-7FH)	ETX (03H)
--------------	--------------------	------------------------------------	--------------

- Return Command Format (Camera to Host)

Normally, a camera returns a control code which is ACK or NAK.

If return value has a text message, the message is between STX and ETX.

ACK (06H)	... Succeed
--------------	-------------

NAK (15H)	... Fail
--------------	----------

STX (02H)	command (2byte)	parameter(ASCII code) (2FH- 7FH)	ETX (03H)	... return message
--------------	--------------------	-------------------------------------	--------------	--------------------

- Command list

Command	Function
SR	Set some values of resister
GR	Get some values of resister
SU	Set a user's data
GU	Get a user's data
CS	Save all configurations
CR	Restore all configurations
QM	Get a model name
QS	Get a serial number
QV	Get a firmware version
QE	Get a detail of error information

8.1.Command Specifications

1) Set some values of resister

【Command】 Set : Resister

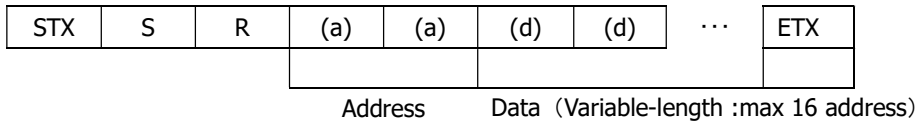

【Return Value】

Succeed	...	ACK
Fail	...	NAK

2) Get some value of resister

【Command】 Get : Resister

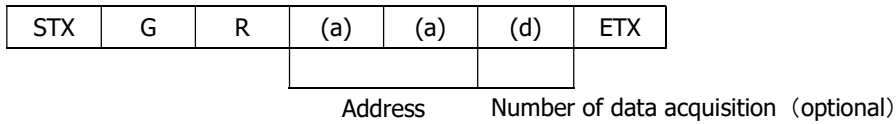

【Return value】

Succeed	...	STX	A	R	(d)	(d)	...	ETX
		Data (Data length depends on the number of acquisitions)						
Fail	...	NAK						

【Remarks】

The command gets some value of register of the specified address. The number of the acquisition is between '0' and 'F' (Hexadecimal).

If appoint '0' at the address, the command send data of 16 address. If the command is omitted at the address, the command send an address.

3) Set User's data

【Command】 Set : User's data

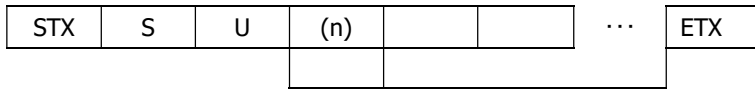

Table No. User's data (fixed length :16byte)
(0~3)

【Return Value】

Succeed	...	ACK
Fail	...	NAK

【Remarks】

The commands, sets free data on the specified register, and can use 4 tables (1 table : 16 characters).

4) Get User's data

【Command】 Get : User's data

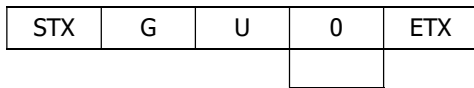
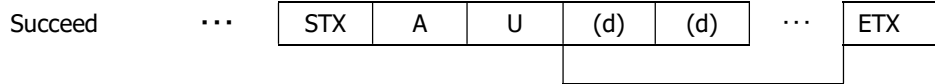

Table No.
(0~3)

【Response】



User's data (fixed length : 16byte)



5) Save all configurations

【Command】 Configuration : Save

STX	C	S	ETX
-----	---	---	-----

【Return Value】

Succeed	...	ACK
Fail	...	NAK

6) Restore all configurations

【Command】 Configuration : Restore

STX	C	R	ETX
-----	---	---	-----

【Return Value】

Succeed	...	ACK
Fail	...	NAK

7) Get a model name

【Command】 Query : Model name

STX	Q	M	ETX
-----	---	---	-----

【Return Value】

Succeed	...	STX	R	M	(d)	(d)	...	ETX
					Model name (Fixed length: 16byte)			
Fail	...	NAK						

8) Get a serial number

【Command】 Query : Serial number

STX	Q	S	ETX
-----	---	---	-----

【Return Value】

Succeed	...	STX	R	S	(d)	(d)	...	ETX
					Serial Number(Fixed length: 8byte)			
Fail	...	NAK						

9) Get a firmware version

【Command】 Query : Version

STX	Q	V	ETX
-----	---	---	-----

【Return Value】

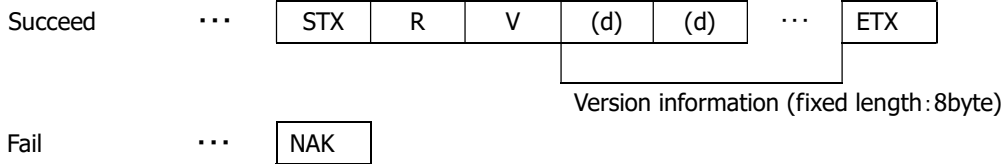

10) Get a detail of error information

【Command】 Query : Error

STX	Q	E	ETX
-----	---	---	-----

【Return Value】

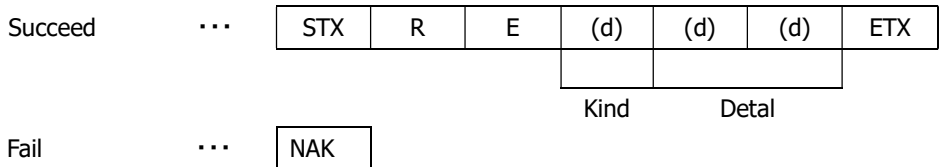

Kind	Detail
0: No Error	00: Normal result
1: Communication Protocol Error	00: The command is undefined.
	01: The command length is more than defined.
	02: The address is undefined.
	03: The value of data is undefined.
	04: The length is more than defined.
	05: The table number is undefined.
	06: The string of user data was abnormal.
2: Internal Control Error	00: Internal control is abnormal.
	01: A read only address was written by the command.
	02: A protected address was written by the command.
	03: Out of range address was written by the command.
	04: The selected table number is abnormal.
	05: The value of the man acquisition area is abnormal.
	06: A function is not implemented.

8.2.Control Example

1) How to check trigger shutter mode. (The command gets a value from address 04)

【Send Command】

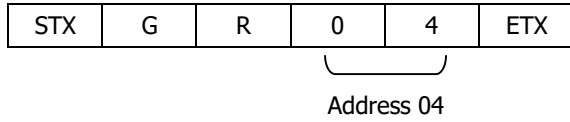

【Return value form camera】

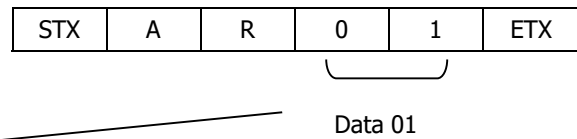

【Receive Return Value】

The camera is working with a trigger shutter mode, because the command received a 01 from the camera.

2) How to check trigger shutter mode. (The command gets consecutive 2 bytes values from address 20)

【Send Command】

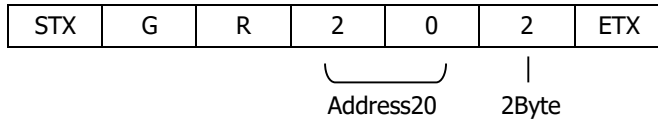

【Receive return value】

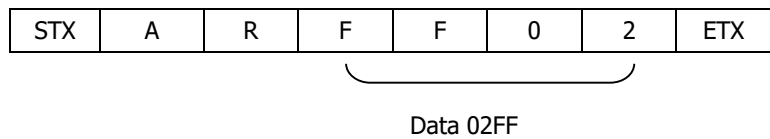

【Receive return value】

The shutter mode of camera is working +12dB, because the command received a 02FF(767) from the camera.

3) How to set partial scan mode. (The command sets 01 for address 08)

【Send Command】

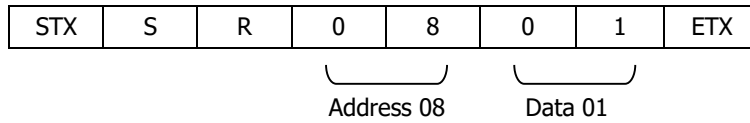

【Return value form camera】

ACK

【Receive Return Value】

The command finished normally, because the command received ACK from the camera.

4) How to set 01FF for manual shutter. (The command set 01FF for address 24)

【Send Command】



【Return value form camera】

ACK

【Receive Return Value】

The command finished normally, because the command received ACK from the camera.

5) How to save configurations of a camera. (The command send CS)

【Send Command】



【Return value form camera】



【Receive Return Value】

The command finished normally, because the command received ACK from the camera.

6) How to restore the camera to initial settings. (The command send CR)

【Send Command】



【Return value form camera】



【Receive Return Value】

The command finished normally, because the command received ACK from the camera.

7) How to get detail of a communication error.

【Send Command】

STX	G	R	@	0	ETX
-----	---	---	---	---	-----

Set the address invalid value

【Return value form camera】

NAK

【Receive return value】

The command finished abnormally, because the command received 'NAK' from the camera.
When the command did not finish normally, retry to send command or send to get detail of a detail error command.

【Send Command】

STX	Q	E	ETX
-----	---	---	-----

【Return value form camera】

STX	R	E	1	0	2	ETX
-----	---	---	---	---	---	-----

Kind1 Detail 02

【Receive Return Value】

The 'GR' command accessed invalid address , because the error command received kind '1' and detail '02'.

9. Function Setting

Function	Address(Hex)	Data(Hex)				
Gain Mode	00	00:	0dB			
		01:	6dB			
		02:	12dB			
		03:	Manual			
		04:	Auto *Fixed Trigger Mode : Manual Mode			
		05:	AE Lock			
Shutter Mode	01		USB3.0 / Camera Link Normal Shutter	USB3.0 / Camera Link Fixed Trigger Shutter	USB2.0	
		00:	1/54s(OFF)	1/45s(OFF)	1/15s(OFF)	
		01:	1/75s	1/75s	1/30s	
		02:	1/100s	1/100s	1/45s	
		03:	1/150s	1/150s	1/75s	
		04:	1/350s	1/350s	1/100s	
		05:	1/500s	1/500s	1/150s	
		06:	1/1000s	1/1000s	1/350s	
		07:	1/2500s	1/2500s	1/500s	
		08:	1/5000s	1/5000s	1/1000s	
		09:	1/7500s	1/7500s	1/2500s	
		0A:	1/10500s	1/9000s	1/3000s	
		0B:	1/13000s	1/11250s	1/3700s	
		0C:	1/18000s	1/15000s	1/5000s	
		0D:	1/54000s	1/45000s	1/15000s	
		0E:	1/54000s	1/45000s	1/15000s	
		0F:	Manual (Address 24-25)			
		10:	Auto *Fixed Trigger Mode : Manual Mode			
11:	AE Lock					

Function	Address(Hex)	Data(Hex)	
White Balance (Color Model)	02	00:	THRU
		01:	3200K
		02:	THRU(Spare)
		03:	Manual
		04:	Auto *Fixed Trigger Mode : Manual Mode
		05:	AWB Lock
AE Level	03	00:	0dB
		01:	- 6dB
		02:	- 4dB
		03:	- 2dB
		04:	0dB
		05:	+ 2dB
		06:	+ 4dB
		07:	+ 6dB
Trigger Shutter Mode	04	00:	Normal Shutter Mode (Trigger OFF)
		01:	Fixed Trigger Shutter Mode
Trigger Polarity	05	00:	Positive
		01:	Negative
Trigger Input (* 1)	06	00:	CN1
		01:	CC1
		02:	12pin Connector 11pin
		03:	Soft Trigger
Partial Scan Mode	08	00:	Full Frame
		01:	Partial Scan
Interface Mode (* 2)	0A	00:	USB YUV / Camera Link 1Tap Base Configuration
		01:	USB YUV / Camera Link 2Tap Base Configuration
		02:	USB YUV / Camera Link Base Configuration 24bit – RGB
		03:	USB RAW / Camera Link 1Tap Base Configuration
		04:	USB RAW / Camera Link 2Tap Base Configuration
		05:	USB RAW / Camera Link Base Configuration 24bit – RGB

*1 : Soft Trigger -> Only USB Output

*2 : USB RAW and Camera Link Base Configuration 24bit – RGB -> Only Color Model

Function	Address(Hex)	Data(Hex)	
Output Mode (* 3)	0B	00:	8bit
		01:	10bit
		02:	12bit
USB Mode	0C	00:	Auto
		01:	USB3.0 Fixed
		02:	USB2.0 Fixed
Baud rate (* 3, * 4)	10	00:	9600bps
		01:	19200bps
		02:	38400bps
		03:	57600bps
		04:	115200bps
Communication Port (* 4)	11	00:	Auto USB > Camera Link
		01:	UVC Extension Units (USB) Fixed
		02:	Serial Port (Camera Link) Fixed
Flip	18	00:	Normal
		01:	Flip upside down
		02:	Flip horizontal
		03:	01 + 02
LED	1B	00:	OFF
		01:	ON

*3 : Only Camera Link

*4 : Change the function ->SAVE->Camera restart

Function	Address(Hex)	Data(Hex)	
Manual Gain	20-21	0 – 2FF:	min:0(0H) - max:767(2FFH) 0: x1(0dB) , 256: x2(+6dB), 767: x4(+12dB)
Manual Shutter	24-25	LLHH:	min:0(0H) - max:984(3D8H) USB3.0 / Camera Link Normal Shutter Mode Exposure Time = (985 – Setting Value) x 18.69us min:0= 18.41ms (1/54.3s) , max:984 = 18.69us (1/54000s) USB3.0 / Camera Link Fixed Trigger Shutter Mode Exposure Time = (985 – Setting Value) x 22.22us min:0= 21.89ms (1/45.7s) , max:984 = 22.22us (1/45000s) USB2.0 Exposure Time = (985 – Setting Value) x 67.34us min:0= 66.33ms (1/15.1s) , max:984 = 67.34us (1/15000s)
Manual White Balance R (Color Model)	28-29	LLHH:	min:0(0H) - max:767(2FFH) 0: x1(0dB), 767: x4(+12dB)
Manual White Balance B (Color Model)	2A-2B	LLHH:	min:0(0H) - max:767(2FFH) 0: x1(0dB), 767: x4(+12dB)
Manual White Balance G (Color Model)	2C-2D	LLHH:	min:0(0H) - max:767(2FFH) 0: x1(0dB), 767: x4(+12dB)
Partial Scan Start Position	40-41	LLHH:	min:0(0H) - max:960(3C0H) * Setting Value = 2 x n
Partial Scan Effective Line Number (* 5)	50-51	LLHH:	min:2(2H) - max:962(3C2H)

*5 : For USB output, set the effective line number with UVC Commit Control.

※ LLHH : The data set with 2 Byte shall be set with Low Byte first, then set with High Byte.

< Example > Manual Gain(Address 24-25) ->767(02FFH)

STX SR 24 FF 02 ETX

10. Dimensions

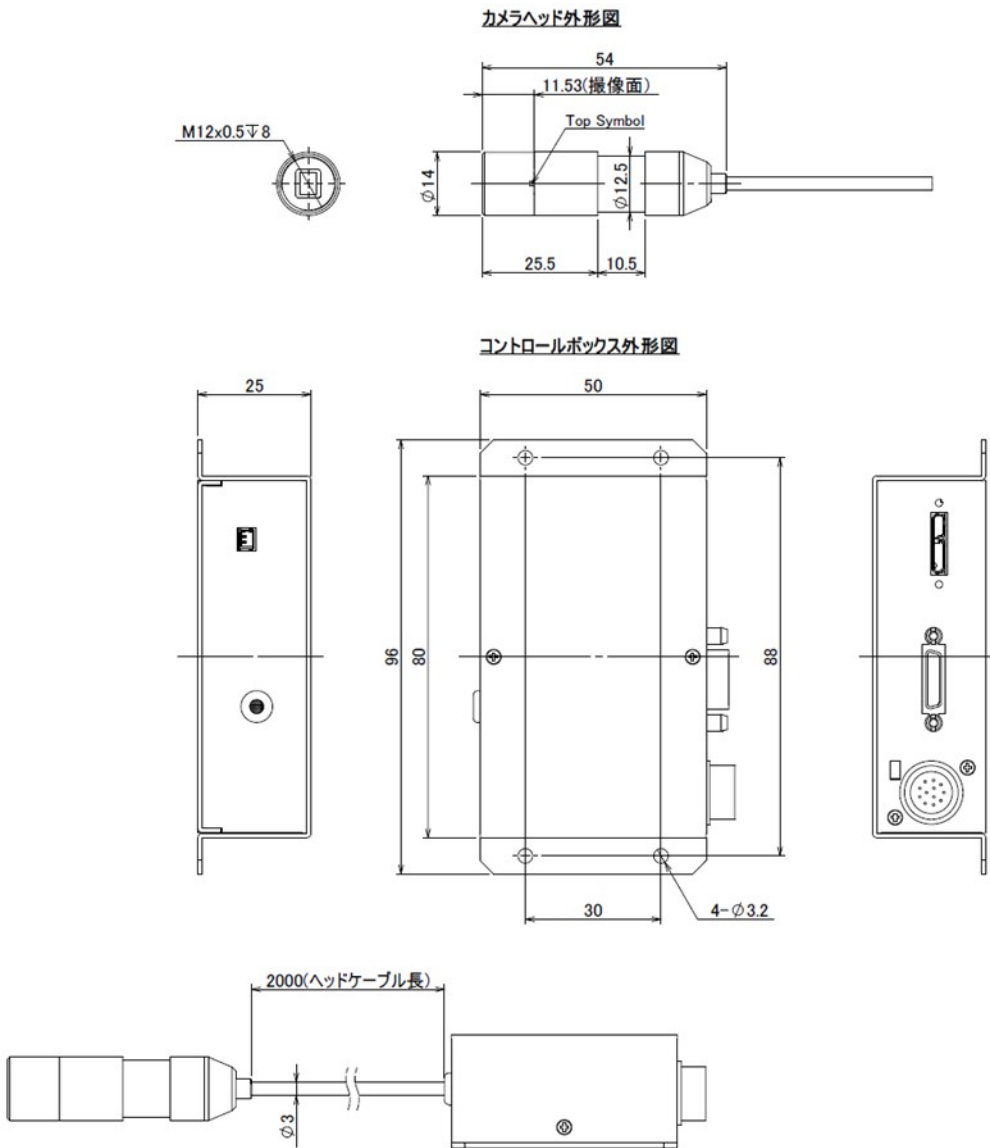

(mm)

11. Initial Setting

Function	Address	Data	
Gain Mode	00	00:	0dB
Shutter Mode	01	00:	OFF *
White Balance Mode (Color)	02	00:	THRU
AE Level	03	00:	0dB
Trigger Shutter Mode	04	00:	Normal Shutter Mode(OFF)
Trigger Polarity	05	00:	Positive
Trigger Input	06	00:	CN1
Partial Scan Mode	08	00:	Full Frame
Interface Mode	0A	00:	USB YUV/Camera Link 1Tap Base Configuration
Output Mode	0B	00:	8bit
USB Mode	0C	00:	Auto
Baud rate	10	00:	9600bps
Communication Port	11	00:	Auto
Flip	18	00:	Normal
LED	1B	01:	ON
Manual Gain	20-21	0000:	0dB
Manual Shutter	24-23	0000:	Shutter(OFF)
Manual White Balance R (Color)	28-29	0000:	0dB
Manual White Balance B (Color)	2A-2B	0000:	0dB
Manual White Balance G (Color)	2C-2D	0000:	0dB
Partial Scan Start Position	40-41	0000:	Start Position 0
Partial Scan Effective Line Number	50-51	03C2:	Effective Line Number 962

- USB3.0 / Camera Link : 1/54s, USB2.0 : 1/15s

12. Cases for Indemnity (Limited Warranty)

We shall be exempted from taking responsibility and held harmless for damage or losses incurred by the user in the following cases.

- In case damage or losses are caused by fire, earthquake, or other acts of God, acts by third party, deliberate or accidental misuse by the user, or use under extreme operating conditions.
- In case indirect, additional, consequential damages (loss of business interests, suspension of business activities) are incurred as result of malfunction or non-function of the equipment, we shall be exempted from responsibility for such damages.
- In case damage or losses are caused by failure to observe the information contained in the instructions in this product specification & operation manual.
- In case damage or losses are caused by use contrary to the instructions in this product specification & operation manual.
- In case damage or losses are caused by malfunction or other problems resulting from use of equipment or software that is not specified.
- In case damage or losses are caused by repair or modification conducted by the customer or any unauthorized third party (such as an unauthorized service representative).

13. CMOS Pixel Defect

IDULE compensates the noticeable CMOS pixel defects found at the shipping inspection prior to our shipment. On very rare occasions, however, CMOS pixel defects might be noted with time of usage of the products.

Cause of the CMOS pixel defects is the characteristic phenomenon of CMOS itself and IDULE is exempted from taking any responsibilities for them. Should you have any questions on CMOS pixel defects compensation, please contact us.

14. Product Support

When defects or malfunction of our products occur, and if you would like us to investigate on the cause and repair, please contact your distributors you purchased from to consult and coordinate.